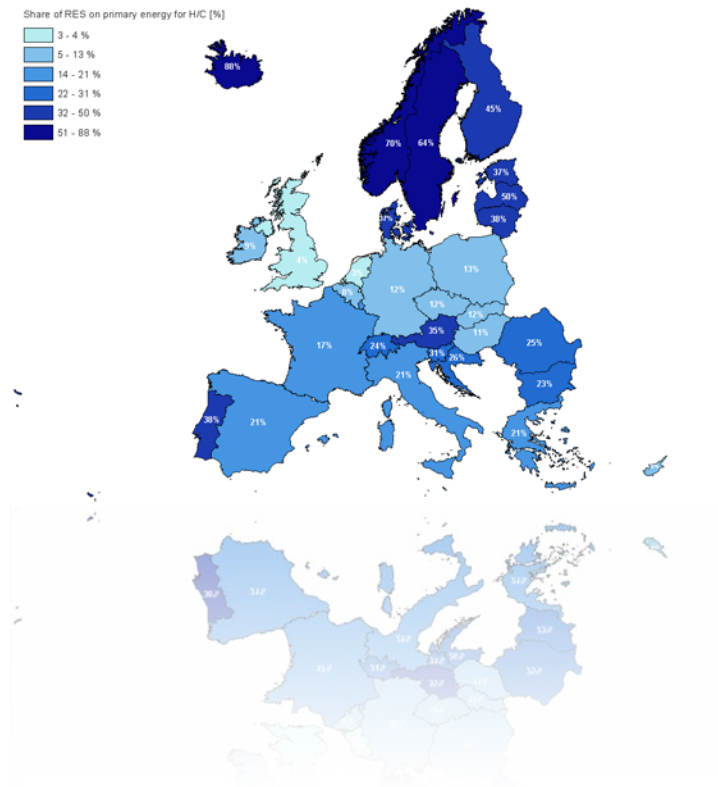


## Mapping and analyses of the current and future (2020 - 2030) heating/cooling fuel deployment (fossil/renewables)



Work package 2: Assessment of the technologies for the year 2012

**Final report**

March 2016

## Authors

### Fraunhofer Institute for Systems and Innovation Research (ISI)

#### Project coordination:

Tobias Fleiter - Email: [tobias.fleiter@fraunhofer.isi.de](mailto:tobias.fleiter@fraunhofer.isi.de)

Jan Steinbach - Email: [jan.steinbach@fraunhofer.isi.de](mailto:jan.steinbach@fraunhofer.isi.de)

Mario Ragwitz - Email: [mario.ragwitz@fraunhofer.isi.de](mailto:mario.ragwitz@fraunhofer.isi.de)

Marlene Arens, Ali Aydemir, Rainer Elsland, Tobias Fleiter, Clemens Frassine, Andrea Herbst, Simon Hirzel, Mario Ragwitz, Matthias Rehfeldt, Matthias Reuter, Jan Steinbach

Breslauer Strasse 48, 76139 Karlsruhe, Germany

### Fraunhofer Institute for Solar Energy Systems (ISE)

Jörg Dengler, Benjamin Köhler, Arnulf Dinkel, Paolo Bonato, Nauman Azam, Doreen Kalz

Heidenhofstr. 2, 79110 Freiburg, Germany

### Institute for Resource Efficiency and Energy Strategies GmbH (IREES)

Felix Reitze, Felipe Andres Toro Chacon, Philipp Willmann, Sami Maliha, Michael Schoen

Schönfeldstr. 8, 76131 Karlsruhe, Germany

### Observ'ER

Frédéric Tuillé, Gaëtan Fovez, Diane Lescot

146 rue de l'Université, 75007 Paris, France

### Technical University Vienna - Energy Economics Group (EEG)

Michael Hartner, Lukas Kranzl, Andreas Müller, Sebastian Fothuber, Marcus Hummel, Albert Hiesl, Gustav Resch, Eric Aichinger

Gusshausstrasse 25-29/370-3, 1040 Vienna, Austria

### TEP Energy GmbH (TEP)

Ulrich Reiter, Giacomo Catenazzi, Martin Jakob, Claudio Naegeli

Rotbuchstr.68, 8037 Zurich, Switzerland

## Quality Review

Prof. Wolfgang Eichhammer

Fraunhofer Institute for Systems and Innovation Research (ISI)

Prof. Hans-Martin Henning

Fraunhofer Institute for Solar Energy Systems (ISE)

# Table of contents

<b>1</b>	<b>Objective and approach.....</b>	<b>1</b>
1.1	Objective.....	1
1.2	Methodology .....	2
<b>2</b>	<b>Space heating and cooling technologies .....</b>	<b>8</b>
2.1	Fossil fuel boilers .....	9
2.2	Direct electrical heating systems .....	25
2.3	Combined heat and power technologies .....	32
2.4	Heat pumps .....	45
2.5	Biomass boilers.....	52
2.6	Solar thermal.....	56
2.7	Room air conditioning .....	62
<b>3</b>	<b>Process heating and cooling technologies .....</b>	<b>71</b>
3.1	Steam generation - Steam systems and steam boilers .....	71
3.2	Steam generation - Combined heat and power (CHP).....	86
3.3	Furnaces in the iron and steel industry .....	91
3.4	Furnaces in the cement industry.....	105
3.5	Furnaces in the glass industry .....	117
3.6	Process cooling.....	131
<b>4</b>	<b>Cross-sectoral.....</b>	<b>150</b>
4.1	District heating and cooling .....	150
4.2	Combined heat and power (> 1 MW <sub>th</sub> ).....	165
<b>5</b>	<b>Summary and recommendations .....</b>	<b>176</b>
5.1	Space heating and cooling in buildings .....	177
5.2	Process heating and cooling .....	184
5.3	District heating and cooling .....	185
5.4	Recommendations .....	186
<b>6</b>	<b>Literature .....</b>	<b>187</b>

<b>7</b>	<b>Annex</b> .....	<b>202</b>
7.1	Share of individual heating technologies by country in buildings .....	202
7.2	Proportion of individual fossil and renewable heating technologies in buildings installed before 1992 by country .....	207

## List of figures

Figure 1:	General overview of data sources used and their priority with sources having the highest priority on the top.....	3
Figure 2:	Structure of heat supply technologies. ....	8
Figure 3:	Stock of natural gas boilers in Europe. ....	17
Figure 4:	Stock of oil boilers in Europe. Own illustration. ....	19
Figure 5:	Stock of coal fired boilers in Europe. ....	21
Figure 6:	Age distribution of installed units of natural gas boilers in Europe. ....	22
Figure 7:	Age distribution of installed units of oil boilers in Europe. ....	22
Figure 8:	Age distribution of installed units of coal fired boilers in Europe.....	23
Figure 9:	Installed capacity in MW <sub>th</sub> of natural gas, oil and coal boilers by country. ....	24
Figure 10:	Stock of direct electric heating systems in Europe. Data is not available for Germany, Lithuania, Norway and Iceland. ....	30
Figure 11:	Installed capacity in MW <sub>th</sub> of direct electric heating systems by country. Data is not available for Germany, Lithuania, Norway, Switzerland and Iceland.....	30
Figure 12:	Age distribution of installed units of direct electric heating systems in Europe. ....	31
Figure 13:	Schematic principle of a fuel cell stack. ....	35
Figure 14:	Age of combined heat and power internal combustion engines in buildings in Germany relating to the installed quantity. ....	43
Figure 15:	Age of combined heat and power internal combustion engines in buildings in Germany relating to the installed capacity.....	44
Figure 16:	2012 Power distribution of individual solid biomass stoves (in %). ....	55
Figure 17:	Size distribution of flat plate collectors in Europe in 2012.....	59
Figure 18:	Size distribution of vacuum collectors in Europe in 2012.....	60
Figure 19:	Age distribution of flat plate collectors in 2012.....	60
Figure 20:	Age distribution of vacuum collectors in 2012.....	61
Figure 21:	Residential air conditioning stock in the EU-28. ....	68
Figure 22:	Market development 2004-2014 solar air conditioning and	

	cooling systems in Europe (indicating numbers of installations) and world-wide. ....	70
Figure 23:	Illustration of the system boundaries used in this study for steam systems. ....	73
Figure 24:	Illustration of the steam boiler stock (quantity of boilers) in EU28 countries in 2012. ....	81
Figure 25:	Steam boiler capacity by Member State and fuel for the EU28 Member States, ranked by thermal output capacity [GW <sub>th</sub> ]. ....	84
Figure 26:	Schematic comparison of CHP generation with individual heat and power generation. ....	86
Figure 27:	CHP auto-production by country in 2012 (source: Eurostat 2015d) ....	89
Figure 28:	CHP thermal capacity by fuel type and technology in the UK in 2013 (source: Department of Energy and Climate Change 2015a) ....	90
Figure 29:	Steel production routes. ....	92
Figure 30:	Plant capacity age distribution blast furnace in kt. ....	97
Figure 31:	Blast Furnace Capacity by Country in kt in 2012. ....	97
Figure 32:	Plant capacity age distribution EAF in kt. ....	98
Figure 33:	EAF capacity by country in kt. ....	98
Figure 34:	Plant capacity age distribution coking in kt. ....	99
Figure 35:	Coking capacity by country in kt. ....	99
Figure 36:	Plant capacity age distribution sinter/ pellet in kt. ....	100
Figure 37:	Sinter/ pellet capacity by country in kt. ....	100
Figure 38:	Plant capacity age distribution steelmaking, secondary metallurgy in kt. ....	101
Figure 39:	Steelmaking and secondary metallurgy capacity by country in kt. ....	101
Figure 40:	EAF + blast furnace capacity by country in kt. ....	102
Figure 41:	Plant capacity age distribution "Semi-finished products" in kt. ....	102
Figure 42:	Semi-finished product capacity by country in kt. ....	103
Figure 43:	Finished products plant age distribution in kt. ....	104
Figure 44:	Finished products capacity by country in kt. ....	104

Figure 45:	Industrial process of cement manufacturing. ....	105
Figure 46:	Thermal energy intensity in GJ per ton clinker for the EU 28 and main cement producing countries in Europe.....	107
Figure 47:	Thermal energy demand by capacity and type of kiln. ....	109
Figure 48:	Alternative fuel use in clinker production in Europe, 1990 to 2006 (percentage of total thermal fuel use).....	110
Figure 49:	Type of kiln installed in 2012 based on production capacity. ....	112
Figure 50:	Production of cement in selected European countries and country groups in 2012. ....	113
Figure 51:	Cement production per capita between 2002-2010 (only selected countries are shown). ....	114
Figure 52:	Clinker-to-production ratio (Clinker production divided by cement production) of the EU28 countries in 2010. ....	115
Figure 53:	Share of fuel type in total final energy demand for cement production in the EU28 by country in 2012. ....	116
Figure 54:	Glass production process .....	117
Figure 55:	Shares of capacities of the respective technologies in EU28 and Norway, Switzerland and Iceland [kt/a; %]. ....	126
Figure 56:	Technologies used in the different Glass sectors the EU 28 and Norway, Switzerland and Iceland; Capacities in [kt/a]. ....	127
Figure 57:	Installed capacities [kt/a] by country divided by production sectors in 2012. ....	128
Figure 58:	Installed Capacities by country and technology in 2012 [kt/a]. ....	129
Figure 59:	New furnace capacities in container glass industries since 2000 [kt/a] in EU28 and Norway, Switzerland and Iceland.....	130
Figure 60:	Overview and classification of cooling systems. ....	132
Figure 61:	Scheme of a simple compression refrigeration showing the system boundaries.....	136
Figure 62:	Coefficients of performance for single-staged processes of various refrigerants. ....	140
Figure 63:	Specific investment costs in €/kW cooling power capacity in Europe for different type of chillers and refrigeration systems.....	144
Figure 64:	Process cooling stock in industry in the EU .....	149

Figure 65:	General comparison of total costs of the consumer for local heat generation and district heating, subdivided into heat distribution cost/generation cost depending on grid density (schematic, cost for on-site heating alternative set to 100%) (Persson, Urban, 2015). .....	153
Figure 66:	District heating - Installed thermal capacity and trench length.....	161
Figure 67:	Procedure to calculate the stock distribution (capacity and age category) using Eurostat data and the PLATTS database. ....	166
Figure 68:	Installed thermal capacity of CHP plants (> 1 MW <sub>th</sub> ) in the EU28 in 2012. ....	167
Figure 69:	Thermal capacity of combined heat and power plants in Europe. ....	167
Figure 70:	Relative portion of thermal capacity of combined heat and power plants in Europe. ....	168
Figure 71:	Stock of combined heat and power plants (> 1 MW <sub>th</sub> ) in the EU28 in 2012 as share of total stock. ....	169
Figure 72:	Stock (quantity) of combined heat and power plants in Europe in 2012.....	170
Figure 73:	Relative portion of technologies in the stock of combined heat and power plants in Europe. ....	170
Figure 74:	Age distribution of installed units of CHP plants by technology in Europe. ....	171
Figure 75:	Age distribution of installed units of CHP plants in Europe.....	171
Figure 76:	Age distribution of installed capacity of CHP plants by technology in Europe. ....	172
Figure 77:	Age distribution of installed capacity of CHP plants in Europe. ....	172
Figure 78:	Share of total heat production in CHP by type of activity in 2012. ....	173
Figure 79:	Share of final energy for CHP use (>1 MW <sub>th</sub> ) by fuel type in the EU28 in 2012. ....	174
Figure 80:	Share of final energy for CHP use (>1 MW <sub>th</sub> ) by fuel type and by country in 2012. ....	175
Figure 81:	Installed heating capacity in buildings in EU-28.....	178
Figure 82:	Installed heating units in buildings in Europe.....	178
Figure 83:	Share of heating technologies and total installed capacity by country (EU-28). ....	179



Figure 84:	Share of heating technologies and total installed units by country (EU-28). .....	179
Figure 85:	Share of heating technologies related to final energy carriers in terms of installed units and installed capacity, as well as the share of final energy demand by fuel in the investigated countries. ....	180
Figure 86:	Age of the heating technology stock (in terms of installed capacity) by technology in the EU-28. ....	181
Figure 87:	Installed renewable and fossil fuel (including direct electric) heating units by year of installation and country in the EU-28. ....	182
Source:	own illustration based on the sources given in chapter 2. Figure 88: Age of the heating technology stock (related to installed capacity) by country and for the EU-28. ....	182
Figure 89:	Installed renewable and fossil fuel (including direct electric) heating capacities by year of installation and country in the EU-28. ....	183
Figure 90:	Proportion [%] of heating technologies (related to installed units) installed before 1992. The proportions are indicated for all countries, for which detailed data is available. ....	183



## List of tables

Table 1:	Data provided from the INVERT/ EE-Lab model (Energy Economics Group (EEG), 2015).....	4
Table 2:	Main data source by technology area.....	6
Table 3:	List of individual process heat technologies considered in this study.....	7
Table 4:	Thermal efficiency of fossil fuel boilers in %.....	11
Table 5:	Specific investment costs in €/kW <sub>th</sub> of condensing gas boilers in the EU27 .....	12
Table 6:	Specific investment costs in €/kW <sub>th</sub> of condensing oil boilers in the EU27.....	13
Table 7:	Specific investment costs in €/kW <sub>th</sub> of coal fired boilers in the EU27. ....	14
Table 8:	Specific investment costs in €/kW <sub>th</sub> and O&M costs in % of the investment costs of gas fired boilers in district heating systems. ....	14
Table 9:	Annual costs of operation and maintenance of oil and gas fired condensing boilers as percentage of the investment costs. ....	15
Table 10:	Stock of natural gas boilers in the EU-28 and Switzerland. ....	16
Table 11:	Stock of oil boilers in the EU-28 and Switzerland. ....	18
Table 12:	Stock of coal fired boilers in the EU-28 and Switzerland. ....	20
Table 13:	Thermal efficiency of electric boilers in %.....	26
Table 14:	Specific investment costs in €/kW <sub>th</sub> of electric heating systems in buildings in the EU27.....	27
Table 15:	Stock of direct electric heating systems in the EU-28 and Switzerland.....	29
Table 16:	Overview over current and future CHP technologies. The values given reflect current state of the art units.....	32
Table 17:	Specific investment costs in €/kW <sub>el</sub> of internal combustion engines (CHP-IC) in buildings in the EU27. ....	37
Table 18:	Thermal and electrical efficiency of internal combustion engines (CHP-IC) in %.....	38
Table 19:	Expected efficiency development of internal combustion engines	

	(CHP-IC) presented in International Energy Agency (2010) and COWI, TI, DGC (2013) in %.....	38
Table 20:	Specific investment costs in €/kW <sub>el</sub> of Stirling engine CHPs with an electrical power of below 25 kW <sub>el</sub> in buildings in the EU27.....	39
Table 21:	Specific investment costs in €/kW <sub>el</sub> of fuel cell CHPs with an electrical power of 1.5 – 20 kW <sub>el</sub> in buildings in the EU27.....	41
Table 22:	Stock of CHP – internal combustion engines in selected countries.....	43
Table 23:	Description of ambient heat technologies surveyed.....	45
Table 24:	Technical specification of aerial heat pumps installed in European Union in 2012.....	47
Table 25:	Technical specification of geothermal heat pumps installed in European union in 2012.....	48
Table 26:	Technical specification of heat pump application.....	49
Table 27:	Age distribution of aérothermal heat pumps (in number of units). ....	50
Table 28:	Age distribution of geothermal heat pumps (in number of units). ....	51
Table 29:	Technical specifications of biomass appliances. ....	54
Table 30:	Technical specifications for solar thermal appliances.....	58
Table 31:	Overview of typical characteristics of compression cooling and direct cooling systems.....	65
Table 32:	Overview of typical characteristics of solar driven absorption cooling systems. ....	66
Table 33:	Overview of typical characteristics of solar driven adsorption cooling systems. ....	66
Table 34:	Estimated installed capacity and number of units for EU-28 for Residential chillers (Movables, Reversible split, and only Cooling Split Units) .....	67
Table 35:	Stock of solar cooling systems in European Countries, # of installed systems, 2012. ....	69
Table 36:	Examples of steam utilisation in different sectors.....	72
Table 37:	Efficiency characterisation of natural gas-fired boilers as representative for steam boilers, taken from Gentili et al. 2014. ....	75
Table 38:	Examples of energy-efficiency measures for steam systems (excluding end-uses) based on the US American IAC database.....	77

Table 39:	Efficiency improvements and diffusion of efficiency options in steam boilers.....	78
Table 40:	Estimates of annual EU 28 steam boiler production in terms of units by PRODCOM category as provided by BDH-EHI in the Ecodesign preparatory study.....	80
Table 41:	Assumed share of energy carriers used in the total boiler stock across all EU28 Member States in 2015. ....	82
Table 42:	Stock of steam boiler units by fuel type for the EU28 Member States in 2012. ....	83
Table 43:	Average Summary of CHP performance in the UK in 2014 as average across all plants (source: Department of Energy and Climate Change 2015a).....	87
Table 44:	Calculated average EU28 specific investment costs for industrial CHP technologies by installed capacity [Euro/kW <sub>th</sub> ) ....	88
Table 45:	Thermal and electric impact of energy saving options added by the associated investment and operational costs in case of a retrofit. ....	111
Table 46:	Ranges of specific energy consumption for different glass types. ....	123
Table 47:	Installed furnaces and mean capacities in EU28 and Norway, Switzerland and Iceland.....	127
Table 48:	Examples of process cooling utilization in different industrial sectors. ....	131
Table 49:	Overview of available technologies for industry and services sectors. ....	139
Table 50:	Overview of energy efficiency options for process cooling. ....	142
Table 51:	Specific investment costs in €/kW <sub>el</sub> of industrial cooling systems engines, adjusted to 2013 and extrapolated to the other Member States. ....	143
Table 52:	Overview of contacted organizations with respect to process and space cooling data. ....	146
Table 53:	Estimated installed capacity and number of units for EU-28 for compression refrigeration systems.....	147
Table 54:	Stock of products covered in the Lot 12 EuP for EU-25 and overview of sales.....	148
Table 55:	Supply technology performance. ....	159

Table 56:	Supply technology investment costs.....	160
Table 57:	District heating and cooling characterisation. ....	162
Table 58:	District heating technology supply composition – installed thermal capacity.....	163
Table 59:	District cooling technology supply composition – installed cooling capacity.....	164
Table 60:	Capacity and age categories.....	166

# 1 Objective and approach

## 1.1 Objective

The main objective of work package 2 is the assessment of the heat and cooling supply technologies currently installed in Europe. The assessment is split into two parts. Firstly, the technology stock is assessed and described in detail including installed capacities, the number of installed units and their age distribution. Secondly, technical and economic parameters are described and the current status and developments expected by 2020 and 2030 are examined. The efficiency, lifetime and costs are analysed for all technologies. For the technology assessment and description three major end use categories are distinguished:

- Technologies used in buildings.
- Technologies for industrial processes (also differentiation between the major industrial sectors).
- Technologies used for district heating and cooling.

The technologies which will most likely be introduced on the market by 2030 are described alongside the technologies which are currently in use. The analysis includes technologies at the interface between the heat and electricity sector, such as combined heat and power (CHP) and electrical heat and cooling supply technologies (e.g. heat pumps).

Both the detailed description of the currently installed technology stock, as well as the techno-economic parameters and their development by 2030, are essential for the modelling that is carried out in work package 3. Furthermore, the stock data gives a detailed picture of the status quo of heating technologies in Europe and therefore is an important basis for the formulation of policies in the European heating and cooling sector.

## 1.2 Methodology

### 1.2.1 Heating and cooling technologies in buildings

The selection of the heating and cooling technologies analysed in work package 2 is based on the expertise and the knowledge of the authors in the technologies currently playing major roles in the heating and cooling market in Europe. Furthermore, technologies that are expected to be important in the future are described qualitatively but are not included in the analysis of the current technology stock as, so far, only a few units have been installed. These are e.g. small scale combined heat and power systems using Fuel Cells and Stirling engines or gas heat pumps.

The technical and economic data is based on national and European studies. It is assumed that the technical lifetime and the thermal and electrical efficiency are the same in the different European countries unless there is technical information that indicates otherwise. The reason for this assumption is that the heating technology market is not a national, but an international market in which the technologies have similar characteristics in all countries investigated. The main sources of technical and economic information are studies from the Danish Energy Agency (COWI, TI, DGC, 2012, 2013) and two studies from Germany (Wenzel et al., 2010; BMVBS, 2012). As cost information from these studies was only available for Denmark and / or Germany the costs have been converted to the other European countries following the approach and using the factors applied in the Heat Roadmap Europe: Second Pre-Study (Connolly et al., 2013). In (Connolly et al., 2013) country factors from (BKI, 2011) were used to extrapolate the costs, which were available for Germany, to the other Member states. However, country factors were not available from (Connolly et al., 2013) for Croatia, Iceland, Norway and Switzerland.

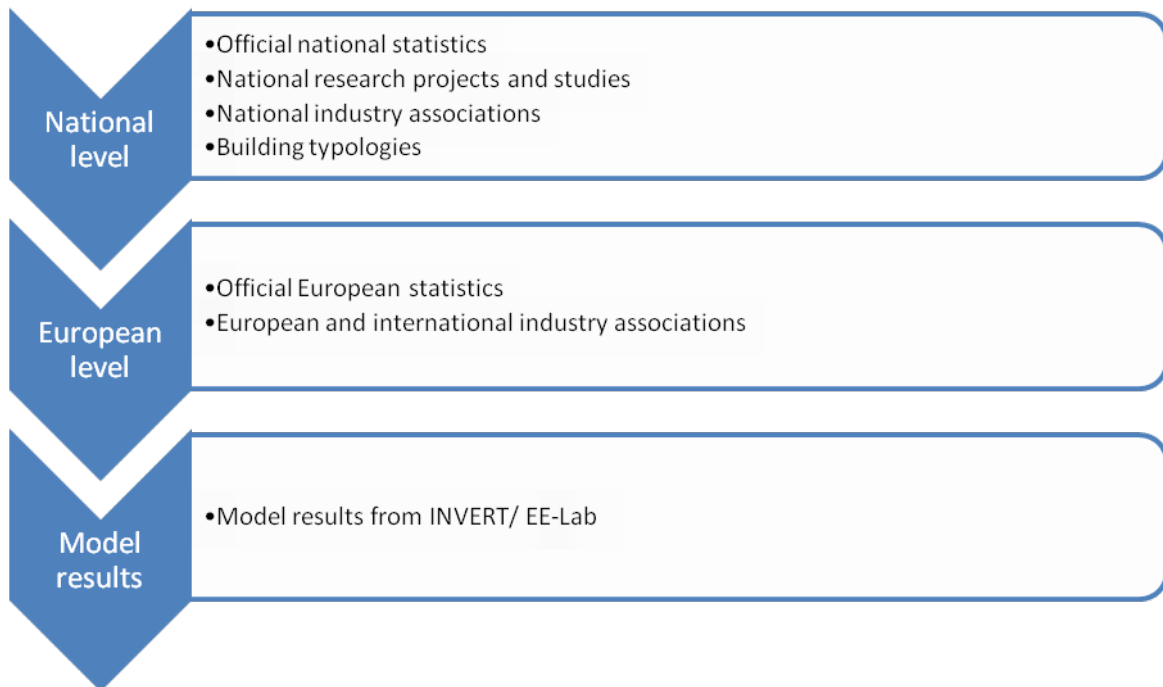
Diverse data sources were used with different priorities in order to retrieve detailed technology stock data. These priorities were based on the data quality and reliability of the source. The sources and the priorities are illustrated in Figure 1 beginning with the sources which have the highest priority.

Studies and statistics at a national level were examined in order to obtain detailed information about the technology stock in each country. In parallel, a questionnaire was developed and sent to national heating technology associations.

If data at a national level was not available or not available at the level of detail required, publicly available data at a European or international level was examined. Industrial associations working at a European level were contacted and a questionnaire, comparable to that sent to national associations, was submitted. Furthermore, an exchange of information with similar projects on European level, such as the TABULA and EPISCOPE/ building stock observatory was initiated.



Figure 1: General overview of data sources used and their priority with sources having the highest priority on the top.



The response rate from associations contacted was lower than expected, as was the level of detail of data on the technology stock in terms of quantity and capacity both from desk research and the questionnaire. Consequently additional calculations from model results from INVERT/ EE-Lab (Energy Economics Group (EEG), 2015) were used to fill the data gaps.

The model results were also used to disaggregate the acquired data (total capacity and/ or total number of units) into the different capacity and age classes used in this project. The capacity classes of all technologies, except solar thermal collectors and heat pumps, were “<25 kW”, “25 – 50 kW”, “51 – 250 kW” and “>250 kW” and the age categories were “Older than technical lifetime”, “Older than half of technical lifetime, newer than technical lifetime” and “Newer than half of technical lifetime”. The data listed in Table 1 was provided by INVERT/ EE-Lab. For the countries that are not listed in the table, data gaps were filled either by using information from neighbouring countries, if appropriate, or by applying average data from all the countries. As the model data cannot be distinguished between condensing and non-condensing boilers, the disaggregation of raw data was only possible for the fuel source i.e. gas, oil and coal heating systems. There were strong deviations between the values of acquired data and the model results (quantity), so relative shares taken from the model results were used to disaggregate the primary statistical data as follows.

For most countries and technologies the quantity of installed units was largely available from studies, the questionnaires returned, and statistics. In a first step, the total number of installed units was apportioned by capacity class using the proportions taken from the model results. In a second step, the total installed units by capacity class were apportioned by age categories again using the proportions calculated by the models. For the calculation it was assumed that each capacity class has the same age distribution.

As there were almost no data available on installed capacities of heating and cooling technologies in buildings, the model results were used as the basis for calculating the

total installed capacity of the different technologies. In this way, the deviation between model results and statistical data was used to adapt the overall capacity from INVERT/ EE-Lab. The modelling results are based on empirical results, model training, technical specifications of buildings and heating technologies and climate conditions. The approach allows deriving average installed capacities of heating technologies in different building types; an approach applied in building typologies and for energy labeling of buildings. The adjusted overall capacity was disaggregated using the same approach as the installed quantities. In a first step the capacity was split into the capacity classes using the shares of installed capacity per capacity class from the model. In the second step, the capacity per capacity class was split into age categories using the shares of the age categories calculated from the model results. If there was no total capacity available from the model results for a specific country and / or technology, the average installed capacity per unit and capacity class was used and multiplied by the number of installed units in order to calculate the total capacity by age and capacity category.

Table 1: Data provided from the INVERT/ EE-Lab model (Energy Economics Group (EEG), 2015).

Country	Technologies	Capacity classes	Age categories	Other
Belgium	Gas	<25 kW	"installed before 1992" (corresponds to "Older than technical lifetime")	Average capacity per unit and capacity class in each country Number of buildings heated by technology
Croatia	Oil	25 – 50 kW		
Cyprus	Coal	51 – 250 kW	"Installed between 1992 and 2002" (corresponds to "Older than half of technical lifetime, newer than technical lifetime")	
Czech Republic	Wood log	>250 kW		
Estonia	Wood chips		"Installed after 2002" (corresponds to "Newer than half of technical lifetime")	
France	Pellets			
Greece	Total electricity			
Hungary	El. heat pump Water/Water			
Ireland	El. heat pump Air/Air			
Luxembourg	El. heat pump Air/Water			
Malta	District heat			
Netherlands	District heat biomass			
Norway				
Romania				
Slovakia				
Slovenia				
Spain				
United Kingdom				

Data on renewable cooling technologies and installed quantities and capacities is barely available as it is, as yet, a relatively small market. The data on renewable cooling in buildings presented in chapter **Fehler! Verweisquelle konnte nicht gefunden werden.** is mainly based on (Mauthner et al.). In (Jakob, U., 2013b) country specific data for 2009 is presented and extrapolated to 2012 at a European level. The information on technical and economic data for this technology is predominantly taken from (Wiemken et al., 2013).

### 1.2.2 Heating and cooling technologies for processes

In 2012, process heating and cooling accounted for about 2100 TWh (of which ~2000 TWh was for process heating) in the EU28+3 (Iceland, Norway and Switzerland),

which is about 63% of total industrial final energy demand (see WP1 for more details).

The heat uses are diverse and spread throughout all industrial branches. Similarly, the technologies used to provide process heat show a huge variety and are often particularly adapted to a certain industry's need. In order to cope with the huge variety of technologies and uses, we identify major energy consuming processes / technology areas to focus the analysis. These are given below (final energy demand in 2012 in parentheses).

1. Furnaces in the iron and steel industry (>500 TWh)
2. Furnaces in the cement industry (~150 TWh)
3. Furnaces in the glass industry (~100 TWh)
4. Steam generation in boilers (300-400 TWh)
5. Steam and hot water generation in combined heat and power (CHP) units (600-700 TWh)
6. Process cooling (~85 TWh)

Compared to the total EU final energy demand for process heating of roughly 2000 TWh in 2012, these technologies account for about 85%. They comprise process heat on a high temperature level (steel, cement, glass) as well as on a medium (steam) and low (hot water) temperature level. The remaining 15% of process heat demand is scattered across smaller processes, mostly in the temperature range above 500°C in individual furnaces. The differentiation of steam generated by CHP and individual steam boilers is not fully possible. The final energy demand for steam boilers (300-400 TWh) is calculated by subtracting the final energy demand for CHP autogeneration according to Eurostat from the total process heat demand <500°C.

Including steam generation as a cross-cutting technology independent of steam use (e.g. paper, chemicals, food) allows us to capture a large share of process heat demand without digging into too many fragmented sub-sectors.

In contrast with individual heating units, these process heat technologies often consist of only a few units per country. As a result, there are commercial databases for many technologies that contain relatively complete information on most individual plants in Europe. Whenever possible, these data have been used to complete the information on the European stock of technologies, particularly using the data sources listed in Table 2. While the database used for CHP technologies (PLATTS) provides very rich and disaggregated data, it does not allow to separate industrial CHP plants from those used in district heating. Consequently, the database is analysed for both sectors together (see [chapter 4.2](#)).

Commercial databases are available for all technological areas except for steam boilers and cooling technologies. For steam boilers we conducted a survey among European Steam Boiler Associations. Unfortunately however, the survey provided only a few data points due to a very low response rate. Thus, stock data for steam boilers stock had to be calculated using a similar approach and assumptions as in the preparatory study for the EU Ecodesign Directive for steam boilers (Gentili et al. 2014). For process cooling a similar approach was used to calculate installed capacities and number of installations based on the electricity demand for process cooling calculated in WP1. Interviews with associations and experts were used to fill data gaps and validate assumptions taken, e.g. on the number of full load hours per technology.

A more detailed description of the data sources used, especially for the techno-economic data, is provided in the individual technology chapters.

Table 2: Main data source by technology area.

Technology area	Main data source for technology stock
Iron and steel	Plant facts database, VDEh
Cement	Global Cement Directory 2013, Cembureau
Glass	plants.glassglobal database, Glass Global
Steam boilers	Calculation based on Ecodesign preparatory study (Survey could not be used due to very low response rate)
Combined heat and power	PLATTS database (As the database does not allow separating industrial from district heating applications, it is analysed in a combined way in chapter 4.2)
Cooling	Calculation based on WP1 electricity consumption plus interviews to validate assumptions taken

A set of individual technologies was analysed for each above mentioned technology area. Each technology area is differentiated in a particular way resulting from the availability and structure of the data sources, but is also driven by the needs of the modeling in WP3. For iron and steel we distinguish individual processes/plants in the production process. For glass and CHP we distinguish individual furnace technologies, while steam boilers are distinguished according to the fuel used. The following individual technologies are analysed by technology area.

Table 3: List of individual process heat technologies considered in this study.

Technology area	Individual technologies
Iron and steel	Blast furnace
	Coking Plant
	Sinter, Pellets
	Steelmaking, secondary metallurgy (basic oxygen furnace, melting furnaces, vacuum degassing, special converter)
	Steel Semi finished Products (Caster, Mills)
	Refined Products (coating, annealing, pickling)
	Electric arc furnace
Cement	Clinker kiln (dry, semi-dry, wet, semi-wet)
Glass	Container glass melting furnace
	Flat glass melting furnace
	Glass fibre melting furnace
	Other glass melting furnace
Steam boilers	Gas fired steam boiler
	Coal fired steam boiler
	Oil fired steam boiler
	Biomass fired steam boiler
	Electricity driven steam boiler
Combined heat and power (see also chapter 4.2)	Steam turbine
	Gas turbine
	Combined cycle
	Internal combustion engine
Cooling	Compression refrigeration

### 1.2.3 Technologies for district heating and cooling

The analysis of the district heating and cooling sector is mainly based on data provided in (Euroheat & Power, 2015). In order to obtain more detailed information and to validate the available data, additional online sources were used. These were mainly national statistical offices and national and European district heating and cooling associations. Where the required data was not available online, the respective national associations and offices were contacted directly. For several technologies, which are not widespread, such as geothermal heat and solar thermal heat in district heating, research platforms and technology associations were also examined and contacted (e.g. European Geothermal Energy Council, plant database published by Solar District Heating (SDH)).

The main source for the technical and economic data was a report published by the Danish Energy Agency containing techno-economic data for both established and new technologies. This provided data on district heat and cooling as well as other energy services (e.g. electricity generation) (COWI, TI, DGC, 2012).

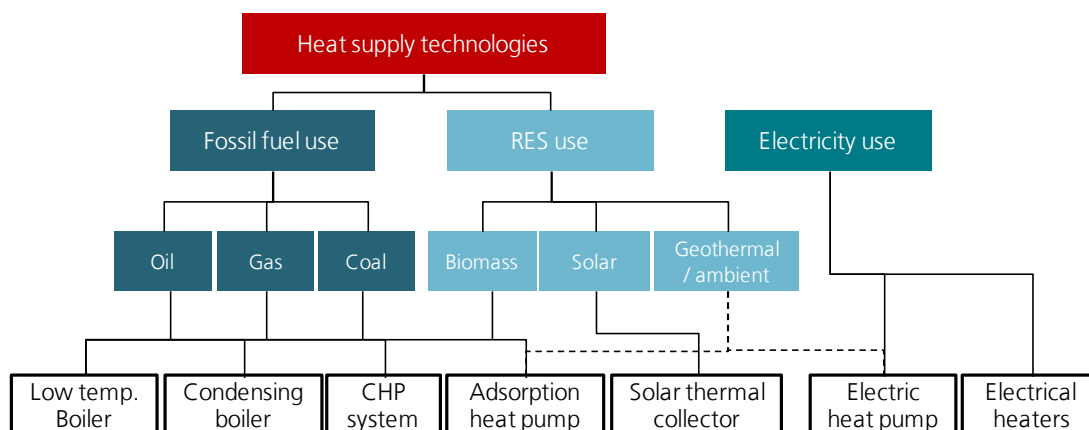
## 2 Space heating and cooling technologies

Individual (decentralised) heating and cooling technologies are described in this chapter. It includes technical and economic parameters such as efficiencies, investment, and operation and maintenance (O&M) costs as well as possible future development potentials. There is also a description of the currently installed technology stock (base year 2012). In this way the installed capacity as well as the installed quantity is assessed. A structure of relevant technologies for heating is presented in Figure 2. Besides conventional technologies like oil and gas boilers, different renewable heating options as well as different combined heat and power systems (e.g. combustion engine, Stirling engine) are also analysed. The following heating and cooling technologies are described below:

- Condensing and non-condensing natural gas fired boilers
- Condensing and non-condensing oil fired boilers
- Coal furnaces
- Combined heat and power:
  - Gas-fired internal combustion engines (in detail)
  - Stirling engines (Techno-economic description)
  - Fuel cells (Techno-economic description)
- Direct electric heating (Radiant and storage heaters)
- Unspecified fossil fuel fired heating systems (stock)
- Biomass furnaces
- Individual biomass stoves
- Electrical aerothermal heat pumps
- Electrical geothermal heat pumps
- Solar thermal flat-plate collector systems
- Solar thermal vacuum tube collector systems
- Compression refrigeration technologies:
  - Moveable air-conditioning systems
  - Reversible split air-conditioning systems
  - Split air-conditioning systems (cold only)

The relative shares, and thereby the importance, of the different decentralised heating technologies in the Member States are illustrated in the Annex (chapter 7.1).

Figure 2: Structure of heat supply technologies.



## **2.1 Fossil fuel boilers**

### **2.1.1 Scope and description of technology**

Boiler technologies burning fossil fuels (heating oil, natural gas or coal (briquettes)) to generate hot water used for space heating and domestic tap water preparation are the most widespread technologies in buildings. In 2008 45% of the heat in residential and service sector buildings was supplied by natural gas and 19% by petroleum products (c.f. Connolly et al., 2012). The proportions have not changed substantially between 2008 and 2012 as oil and gas boiler technologies still dominate the heating technology markets in European countries in terms of sold units. This is despite the fact that alternative technologies, like heat pumps, have gained market shares in the last couple of years. Coal fired boilers and furnaces on the other hand do not play a major role in most countries (an exception is Poland). Fossil fuel fired heating systems usually comprise a boiler, burner, storage tank, and chimney or exhaust system and in the case of oil, LPG (Liquefied Petroleum Gas) or coal fired systems, fuel storage is also required. The following descriptions will focus on the boiler and burner unit. The technologies analysed are condensing oil and natural gas boilers, as well as “standard” boilers using oil or natural gas. This includes all other and older boiler technologies besides condensing boilers, but including low-temperature boilers. The main difference between the two categories is that condensing boilers contain a condensing unit, in which the water vapour in the exhaust gas is condensed. This enables the heat of condensation to be used for heating purposes; in standard boilers this heat is not used. A distinction between wall hanging and floor standing applications is not drawn.

Standard and condensing boilers are available with various thermal capacities. Single room heating applications are available with a capacity of up to 11 kW<sub>th</sub> (see Schramek, 2011). Boilers for whole buildings are available with a capacity of approximately 2 to 2,200 kW<sub>th</sub>, and in special applications up to 5,000 kW<sub>th</sub>.

In principal, natural gas and fuel oil boilers can be fired with biogenous liquid or gaseous fuels. According to COWI, TI, DGC (2013) up to approximately 10% of biooil can be added to fuel oil without causing severe problems. Technically it is also possible to burn pure biooil in boilers, but up to now this has been associated with several technical and maintenance problems. More research and development is needed to generate the widespread application of biooil fired boilers which have a similar performance as boilers burning mineral oils (c.f. COWI, TI, DGC, 2013). The usage of biogas in gas boilers is technically no problem if the biogas is treated as having a calorific value close to natural gas (major CO<sub>2</sub> removal from pure biogas; c.f. (COWI, TI, DGC, 2013). Burning solid biogenous fuels in coal boilers is not described here, as burning solid biomass is part of 2.5.

### **2.1.2 Data acquisition**

The availability of data on installed units and capacities in Europe is very low. There is no European or national statistics on the heating technology stock in terms of installed units and capacities and therefore there are also no statistics divided by capacity class

and age. The major data sources are briefly described in the following:

**Chimney sweeps:** In Germany, chimney sweeps have to collect heating technology stock data annually (see Bundesverband des Schornsteinfegerhandwerks – Zentralin-nungsverband (ZIV), 2013). Several other European countries have recently started to establish similar data collection from chimney sweeps, publishable by chimney sweeper associations<sup>1</sup>. For the year 2012, no such data was available in any country other than Germany.

**Building typologies:** There is more data concerning the number of buildings heated with specific technologies, and the information for residential buildings is published in national building typologies in almost all European countries. The disadvantages of building typologies are that there is no information about the number of applications in one building, the age of the heating technologies installed and the capacity. Furthermore, building typologies only cover residential buildings and not the non-residential buildings, which can make up a large share of national building stocks. The results from Energy Economics Group (EEG) (2015) show that between 50 and 90% of the total thermal capacity is installed in residential buildings. The lowest share is in Cyprus, which has a relatively low heating demand.

**Industry associations:** National and European heating industry associations collect market data from all their member companies and organisations and in some cases these includes statistics on the installed stock. It is usually only aggregated data that are published, and in many cases detailed information as required for this project has not been accessible.

The data presented below is based on several data sources. Wherever possible, national freely accessible data bases have been used (e.g. chimney sweep data in Germany, statistics in Switzerland). Additionally, an enquiry has been made to all heating industry associations in Europe including the European Heating Industry Association EHI to collect more detailed data for as many countries as possible. For countries, for which no statistics or studies were available, building typologies were used as a base line and additional calculations had to be carried out.

### 2.1.3 Technology characterisations

In the following, fossil fuel boilers are characterised in terms of their thermal efficiency, their technical lifetime, and specific investment and operation and maintenance (O&M) costs. The values are given for different capacity classes, and possible developments up until 2030 are described.

The thermal efficiency of the above described boiler types are listed in Table 4. The values given are based on sources from Germany (Wenzel et al., 2010) and Denmark (COWI, TI, DGC, 2013). As the boiler market is international, and the major manufacturers sell their products all over Europe it is assumed that the given efficiencies are achieved in all countries analysed in this study. The actual thermal efficiency can differ from the listed values as a result of different efficiencies in part load operation, user behaviour, maintenance, and the supply and return temperature of the heating sys-

---

<sup>1</sup> Information received in telephone calls with several national associations; a.o. Germany and Austria.



tem. The ranges given for condensing gas boilers result from different temperature levels of the heating system, where the higher thermal efficiency is achieved in low-temperature heating systems (e.g. floor heating) (COWI, TI, DGC, 2013). In Schramek (2011) slightly lower thermal efficiencies are given for condensing gas boilers. Gas boilers usually have a higher thermal efficiency than oil and coal fired boilers. Standard boilers have a decreasing market share and when fossil fuel boilers are installed, they now tend to be condensing boilers. As standard and condensing boilers are established and widespread technologies, no major developments and efficiency increases are expected by 2030 (compare i.a. (Wenzel et al., 2010)).

Table 4: Thermal efficiency of fossil fuel boilers in %.

	<25 kW <sub>th</sub>	25 – 100 kW <sub>th</sub>	101 – 250 kW <sub>th</sub>	251 – 350 kW <sub>th</sub>	> 350 kW <sub>th</sub>	Source
Standard gas boiler	90 <sup>1</sup>	90 <sup>1</sup>	92 <sup>1</sup>	94 <sup>1</sup>	94 <sup>1</sup>	[1]
Condensing gas boiler	100-104 <sup>1</sup> 92-99 <sup>2</sup>	100-104 <sup>1</sup> 92-99 <sup>2</sup>	100-104 <sup>1</sup> 92-99 <sup>2</sup>	100-104 <sup>1</sup> 92-99 <sup>2</sup>	97-105 <sup>1</sup>	[3], [4] [2]
Standard oil boiler	85 <sup>1</sup>	85 <sup>1</sup>	85 <sup>1</sup>	85 <sup>1</sup>	85 <sup>1</sup>	[1]
Condensing oil boiler	100 <sup>1</sup>	100 <sup>1</sup>	98 <sup>1</sup>	96 <sup>1</sup>	96 <sup>1</sup>	[3]
Coal fired boiler	75 <sup>1</sup>	75-85 <sup>1</sup>	89 <sup>1</sup>	89 <sup>1</sup>	89 <sup>1</sup>	[1]

Refers to 1: net calorific value, 2: gross calorific value

Source: [1]: Wenzel et al. (2010); [2] Schramek (2011), [3]: (COWI, TI, DGC, 2013), [4]: COWI, TI, DGC (2012)

The technical lifetime for small gas boilers with a thermal capacity of below 25 kW<sub>th</sub> is 22 years and it is 25 years for larger applications above 25 kW<sub>th</sub> (c.f. COWI, TI, DGC, 2013). According to COWI, TI, DGC (2013) oil boilers have a slightly lower technical lifetime of 20 years. Larger boilers with a thermal capacity of up to 10 MW<sub>th</sub> used in district heating systems have a longer lifetime of 30 to 40 years (see COWI, TI, DGC 2012). No reliable data on the technical lifetime was available for coal fired boilers in the studies mentioned above. Also, since the boiler market is international, the same technical lifetime is assumed for all countries investigated.

While the technical parameters are the same in all European countries, the prices differ, largely because there is a different price level in all countries. In Connolly et al. (2013) cost data for all European countries except Croatia, Iceland, Norway and Switzerland are given. The cost data are based on the German study “Kosten energierelevanter Bau- und Anlagenteile bei der energetischen Modernisierung von Wohngebäuden” (BMVBS, 2012). The German cost data were extrapolated for the other Member States using country factors from BKI (2011) for four capacity classes up to 350 kW<sub>th</sub>. The country specific costs for condensing gas boilers are listed in Table 5, the costs of condensing oil boilers in Table 6, and costs for coal boilers in Table 7. In COWI, TI, DGC (2012) there are also cost data for larger gas fired boilers mainly used in district heating systems (0.5 to 10 MW<sub>th</sub>). The investment and O&M costs for these systems are given in Table 8. Due to the fact that fossil fuel boilers are an established technology (see above) it is not expected that investment and O&M costs will be reduced until 2030 (c.f. (COWI, TI, DGC, 2012), (COWI, TI, DGC, 2013), (Wenzel et al., 2010)). Condensing boiler technologies are the standard nowadays. Therefore there are no cost data for standard (e.g. low-temperature) boilers available in the examined reports and studies.

Table 5: Specific investment costs in €/kW<sub>th</sub> of condensing gas boilers in the EU27 .

	<25 kW <sub>th</sub>	25 – 100 kW <sub>th</sub>	101 – 250 kW <sub>th</sub>	251 – 350 kW <sub>th</sub>
Austria	527	337	123	74
Belgium	429	275	100	60
Bulgaria	196	126	46	28
Croatia	n.a.	n.a.	n.a.	n.a.
Cyprus	324	207	76	45
Czech Republic	286	183	67	40
Denmark	645	413	151	90
Estonia	309	198	72	43
Finland	473	303	110	66
France	517	331	121	72
Germany	522	334	122	73
Greece	315	202	74	44
Hungary	269	172	63	38
Ireland	446	286	104	63
Italy	343	220	80	48
Latvia	361	231	84	51
Lithuania	321	205	75	45
Luxembourg	445	285	104	62
Malta	280	179	65	39
Netherlands	559	358	130	78
Poland	309	198	72	43
Portugal	257	165	60	36
Romania	199	127	46	28
Slovakia	302	193	71	42
Slovenia	330	211	77	46
Spain	356	228	83	50
Sweden	629	402	147	88
United Kingdom	505	323	118	71

Source: based on the values given in Connolly et al. (2013) for the EU27. Country factors for Croatia, Iceland, Norway and Switzerland could not be derived from this source.

Table 6: Specific investment costs in €/kW<sub>th</sub> of condensing oil boilers in the EU27.

	<25 kW	25 – 100 kW	101 – 250 kW	251 – 350 kW
Austria	622	403	153	89
Belgium	506	328	125	72
Bulgaria	232	150	57	33
Croatia	n.a.	n.a.	n.a.	n.a.
Cyprus	382	247	94	54
Czech Republic	338	219	83	48
Denmark	762	493	188	108
Estonia	365	236	90	52
Finland	558	361	138	79
France	610	395	150	87
Germany	616	399	152	88
Greece	372	241	92	53
Hungary	317	205	78	45
Ireland	527	341	130	75
Italy	405	262	100	58
Latvia	426	276	105	61
Lithuania	379	245	93	54
Luxembourg	525	340	129	75
Malta	330	214	81	47
Netherlands	660	427	163	94
Poland	365	236	90	52
Portugal	304	197	75	43
Romania	235	152	58	33
Slovakia	357	231	88	51
Slovenia	389	252	96	55
Spain	420	272	104	60
Sweden	742	480	183	106
United Kingdom	596	386	147	85

Source: based on the values given in Connolly et al. (2013)

Table 7: Specific investment costs in €/kW<sub>th</sub> of coal fired boilers in the EU27.

	<25 kW <sub>th</sub>	25 – 100 kW <sub>th</sub>	101 – 250 kW <sub>th</sub>	251 – 350 kW <sub>th</sub>
Austria	300	151	109	49
Belgium	244	123	89	40
Bulgaria	112	56	41	18
Croatia	n.a.	n.a.	n.a.	n.a.
Cyprus	184	92	67	30
Czech Republic	163	82	59	26
Denmark	367	184	133	59
Estonia	176	88	64	28
Finland	269	135	98	44
France	294	148	107	48
Germany	283	196	140	65
Greece	179	90	65	29
Hungary	153	77	56	25
Ireland	254	127	92	41
Italy	195	98	71	32
Latvia	205	103	74	33
Lithuania	182	92	66	30
Luxembourg	253	127	92	41
Malta	159	80	58	26
Netherlands	318	160	115	51
Poland	176	88	64	28
Portugal	146	73	53	24
Romania	113	57	41	18
Slovakia	172	86	62	28
Slovenia	188	94	68	30
Spain	202	102	74	33
Sweden	358	180	130	58
United Kingdom	287	144	104	47

Source: based on the values given in Wenzel et al. (2010) adjusted to 2012 prices and extrapolated following the methodology in (Connolly et al., 2013) for the EU27. Country factors for Croatia, Iceland, Norway and Switzerland could not be derived from this source

 Table 8: Specific investment costs in €/kW<sub>th</sub> and O&M costs in % of the investment costs of gas fired boilers in district heating systems.

	0.5 MW <sub>th</sub>	10 MW <sub>th</sub>
Specific investment costs [€/kW <sub>th</sub> ]	130	70
O&M costs [% of invest]	2	5

Source: COWI, TI, DGC (2012)

The operation and maintenance (O&M) costs of oil and gas boilers (condensing and

standard) are listed in Table 9. Data was only available from German and Danish studies, but it is assumed that the O&M costs as a percentage of the investment costs are within the range given in the sources all over Europe. O&M costs are lower in the German study than in the Danish study.

Table 9: Annual costs of operation and maintenance of oil and gas fired condensing boilers as percentage of the investment costs.

%	<25 kW	25 – 100 kW	101 – 250 kW	251 – 350 kW	Source
Gas boiler	2	2	4	5	(COWI, TI, DGC, 2012), (COWI, TI, DGC, 2013)
	1	1	1	3	(Wenzel et al., 2010)
Oil boiler	4			3	(COWI, TI, DGC, 2013)
	1	1	1	3	(Wenzel et al., 2010)
Coal fired boiler	2	3	2	6	(Wenzel et al., 2010)

Sources: COWI, TI, DGC (2012), COWI, TI, DGC (2013), Wenzel et al. (2010)

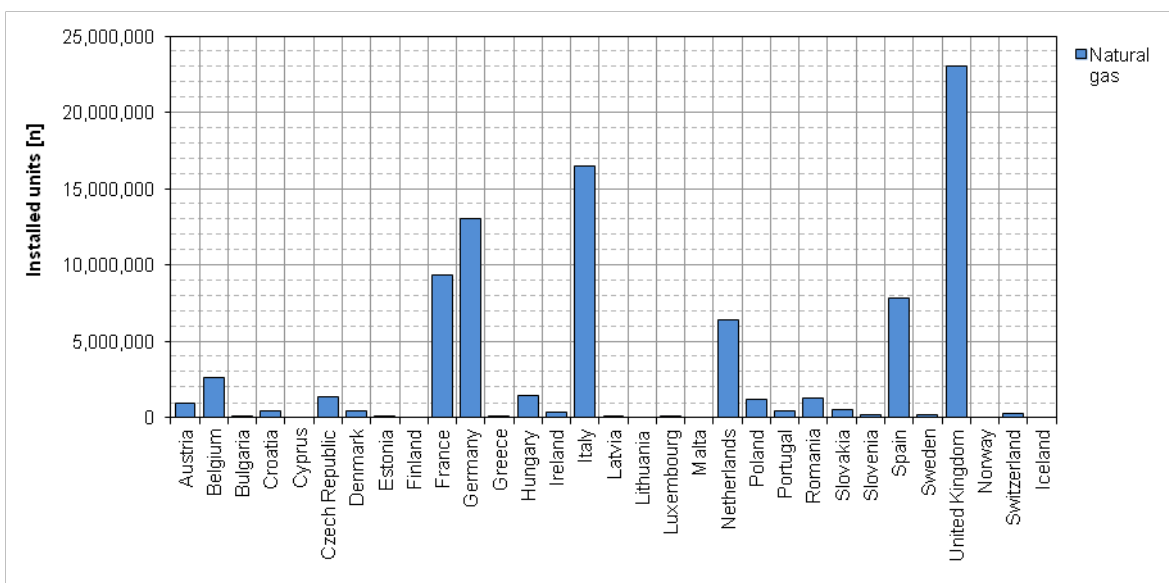
#### 2.1.4 Technology stock distribution

Natural gas and fuel oil boilers are the main heat supply technologies in buildings in the countries investigated. Coal fired boilers play a major role in some Eastern European countries but in most countries they play a minor role. Natural gas boilers comprise 40% of the heating technology stock in Europe, while oil boilers comprise 9% and coal fired boilers 2%. Limited data was available on the technology stock at the level of detail required for this study. Therefore, several data sources had to be used and estimates for the distribution of installed units into capacity classes and the age distribution had to be made based on model results from INVERT/ EE-Lab (Energy Economics Group (EEG), 2015). Furthermore, the model results were used to calculate installed capacities when stock data in terms of installed units was available and vice versa. The stock by capacity class for natural gas fired boilers is listed in Table 10 and illustrated in Figure 3. The installed quantities of oil boilers are listed in Table 11 and illustrated in Figure 4 and the quantities of coal fired boilers are listed in Table 11 and illustrated in Figure 5.

Table 10: Stock of natural gas boilers in the EU-28 and Switzerland.

	<25 kW	25 – 100 kW	101 – 250 kW	>250 kW	Total	Share of condensing boilers
Austria	765,224 <sup>a</sup>	106,892 <sup>a</sup>	58,807 <sup>a</sup>	0 <sup>a</sup>	930,922 <sup>s</sup>	n.a.
Belgium	2,395,597 <sup>a</sup>	103,972 <sup>a</sup>	179,902 <sup>a</sup>	0 <sup>a</sup>	2,679,471 <sup>s</sup>	2%
Bulgaria	10,934 <sup>a</sup>	21 <sup>a</sup>	101 <sup>a</sup>	0 <sup>a</sup>	11,056 <sup>s</sup>	n.a.
Croatia	477,591 <sup>a</sup>	11,069 <sup>a</sup>	1,885 <sup>a</sup>	0 <sup>a</sup>	490,544 <sup>a</sup>	n.a.
Cyprus	0 <sup>s</sup>	0 <sup>s</sup>	0 <sup>s</sup>	0 <sup>s</sup>	0 <sup>s</sup>	n.a.
Czech Republic	981,738 <sup>a</sup>	324,894 <sup>a</sup>	58,645 <sup>a</sup>	0 <sup>a</sup>	1,365,277 <sup>s</sup>	n.a.
Denmark	424,940 <sup>a</sup>	2,529 <sup>a</sup>	330 <sup>a</sup>	0 <sup>a</sup>	427,800 <sup>s</sup>	n.a.
Estonia	5,746 <sup>a</sup>	957 <sup>a</sup>	1,607 <sup>a</sup>	0 <sup>a</sup>	8,310 <sup>a</sup>	n.a.
Finland	0 <sup>s</sup>	0 <sup>s</sup>	0 <sup>s</sup>	0 <sup>s</sup>	0 <sup>s</sup>	n.a.
France	8,684,289 <sup>a</sup>	356,402 <sup>a</sup>	330,199 <sup>a</sup>	0 <sup>a</sup>	9,370,890 <sup>s</sup>	13%
Germany	10,768,281 <sup>s</sup>	1,504,186 <sup>s</sup>	827,532 <sup>s</sup>	0 <sup>s</sup>	13,100,000 <sup>s</sup>	31%
Greece	75,706 <sup>a</sup>	31,413 <sup>a</sup>	0 <sup>a</sup>	0 <sup>a</sup>	107,119 <sup>a</sup>	n.a.
Hungary	1,388,273 <sup>a</sup>	76,190 <sup>a</sup>	1,882 <sup>a</sup>	0 <sup>a</sup>	1,466,344 <sup>s</sup>	n.a.
Ireland	395,238 <sup>a</sup>	440 <sup>a</sup>	0 <sup>a</sup>	0 <sup>a</sup>	395,678 <sup>a</sup>	n.a.
Italy	12,607,807 <sup>a</sup>	3,927,738 <sup>a</sup>	0 <sup>a</sup>	0 <sup>a</sup>	16,535,545 <sup>s</sup>	13%
Latvia	30,193 <sup>a</sup>	0 <sup>a</sup>	5,994 <sup>a</sup>	380 <sup>a</sup>	36,567 <sup>a</sup>	n.a.
Lithuania	n.a.	n.a.	n.a.	n.a.	n.a.	n.a.
Luxembourg	63,926 <sup>a</sup>	965 <sup>a</sup>	142 <sup>a</sup>	0 <sup>a</sup>	65,033 <sup>a</sup>	n.a.
Malta	0 <sup>s</sup>	0 <sup>s</sup>	0 <sup>s</sup>	0 <sup>s</sup>	0 <sup>s</sup>	n.a.
Netherlands	5,169,721 <sup>a</sup>	1,176,592 <sup>a</sup>	47,767 <sup>a</sup>	0 <sup>a</sup>	6,394,080 <sup>s</sup>	82%
Poland	727,080 <sup>a</sup>	126,127 <sup>a</sup>	360,665 <sup>a</sup>	0 <sup>a</sup>	1,213,872 <sup>s</sup>	n.a.
Portugal	461,044 <sup>a</sup>	0 <sup>a</sup>	0 <sup>a</sup>	0 <sup>a</sup>	461,044 <sup>a</sup>	n.a.
Romania	1,260,619 <sup>a</sup>	0 <sup>a</sup>	5,502 <sup>a</sup>	0 <sup>a</sup>	1,266,121 <sup>a</sup>	n.a.
Slovakia	557,559 <sup>a</sup>	4,894 <sup>a</sup>	2,794 <sup>a</sup>	0 <sup>a</sup>	565,246 <sup>a</sup>	n.a.
Slovenia	168,107 <sup>a</sup>	66,515 <sup>a</sup>	5,102 <sup>a</sup>	0 <sup>a</sup>	239,725 <sup>s</sup>	1%
Spain	4,863,451 <sup>a</sup>	2,769,484 <sup>a</sup>	246,216 <sup>a</sup>	0 <sup>a</sup>	7,879,150 <sup>s</sup>	3%
Sweden	115,343 <sup>a</sup>	55,333 <sup>a</sup>	69,324 <sup>a</sup>	0 <sup>a</sup>	240,000 <sup>s</sup>	5%
United Kingdom	22,238,403 <sup>a</sup>	615,584 <sup>a</sup>	232,269 <sup>a</sup>	0 <sup>a</sup>	23,086,257 <sup>s</sup>	58%
EU-28	74,636,810	11,262,196	2,436,665	380	88,336,051	n.a.
Iceland	n.a.	n.a.	n.a.	n.a.	n.a.	n.a.
Norway	n.a.	n.a.	n.a.	n.a.	n.a.	n.a.
Switzerland	n.a.	n.a.	n.a.	n.a.	256,820	n.a.
Methodology:	Sources: (IDAE, 2011; Narodowa Agencja Poszanowania Energii SA NAPE, 2012; Sofia Energy Agency - SOFENA, 2012; Bundesverband des Schornsteinfegerhandwerks – Zentralinnungsverband (ZIV), 2013; Statistik Austria - Bundesanstalt Statistik Österreich, 2013; TU Delft, 2013; Bundesverband des Schornsteinfegerhandwerks – Zentralinnungsverband (ZIV), 2014; Gradbeni inštitut ZRMK d.o.o., 2014; Budapest University of Technology and Economics, Department of Environmental Economics, 2015; Bundesamt für Statistik BFS, 2015; Danish Energy Agency, 2015; STÚ-K, 2015; Breidenbach and Leers, Frederic (Bundesverband der Deutschen Heizungsindustrie e.V. (BDH)), 2015; van Campenhout, 2015; Energy Economics Group (EEG), 2015; Knezevic, Vanesa (European Heating Industry (EHI)), 2015)					
x = interpolation/ extrapolation						
a = ad hoc calculation						
s = direct use of the source						
m = modelling						

Figure 3: Stock of natural gas boilers in Europe.



Source: own illustration based on sources listed in Table 10

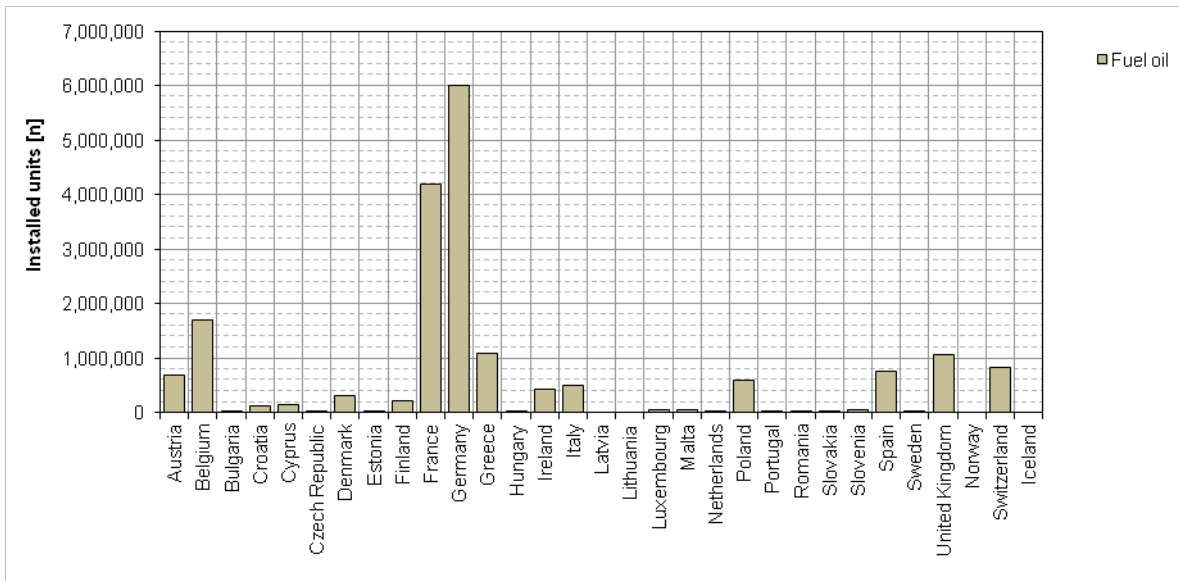
The countries with the largest number of natural gas boilers installed are the United Kingdom (UK), Italy, Germany and France, while there are no units installed in Malta and Cyprus, which are islands and not yet connected to the gas-pipeline grid (for Lithuania no data is available). In Finland natural gas boilers are not installed as space heating is mainly provided by biomass stoves and furnaces and electric heating systems (direct electric and heat pumps). The main reasons are the availability of biomass and electricity from hydro and nuclear power plants. Furthermore, natural gas is mainly used in industrial and municipal CHP plants, but not for decentral heat generation.

Table 11: Stock of oil boilers in the EU-28 and Switzerland.

	<25 kW	25 – 100 kW	101 – 250 kW	>250 kW	Total	Share of condensing boilers
Austria	364,265 <sup>a</sup>	280,530 <sup>a</sup>	56,053 <sup>a</sup>	0 <sup>a</sup>	700,848 <sup>s</sup>	n.a.
Belgium	1,629,108 <sup>a</sup>	25,203 <sup>a</sup>	43,615 <sup>a</sup>	0 <sup>a</sup>	1,697,927 <sup>s</sup>	2%
Bulgaria	3,682 <sup>a</sup>	1 <sup>a</sup>	3 <sup>a</sup>	0 <sup>a</sup>	3,685 <sup>s</sup>	n.a.
Croatia	118,709 <sup>a</sup>	14,604 <sup>a</sup>	5,944 <sup>a</sup>	0 <sup>a</sup>	139,257 <sup>a</sup>	n.a.
Cyprus	132,318 <sup>a</sup>	11,900 <sup>a</sup>	1,167 <sup>a</sup>	0 <sup>a</sup>	145,385 <sup>a</sup>	n.a.
Czech Republic	7,503 <sup>a</sup>	203 <sup>a</sup>	38 <sup>a</sup>	0 <sup>a</sup>	7,744 <sup>a</sup>	n.a.
Denmark	326,513 <sup>a</sup>	1,704 <sup>a</sup>	223 <sup>a</sup>	0 <sup>a</sup>	328,440 <sup>s</sup>	n.a.
Estonia	3,103 <sup>a</sup>	517 <sup>a</sup>	870 <sup>a</sup>	0 <sup>a</sup>	4,489 <sup>a</sup>	n.a.
Finland	203,459 <sup>a</sup>	14,682 <sup>a</sup>	8,385 <sup>a</sup>	0 <sup>a</sup>	226,526 <sup>a</sup>	n.a.
France	4,118,094 <sup>a</sup>	47,764 <sup>a</sup>	44,252 <sup>a</sup>	0 <sup>a</sup>	4,210,110 <sup>s</sup>	13%
Germany	3,118,490	2,401,637	479,873	0	6,000,000 <sup>s</sup>	8%
Greece	934,355 <sup>a</sup>	148,989 <sup>a</sup>	0 <sup>a</sup>	0 <sup>a</sup>	1,083,344 <sup>a</sup>	n.a.
Hungary	2,664 <sup>a</sup>	298 <sup>a</sup>	12 <sup>a</sup>	0 <sup>a</sup>	2,973 <sup>s</sup>	n.a.
Ireland	445,184 <sup>a</sup>	52 <sup>a</sup>	0 <sup>a</sup>	0 <sup>a</sup>	445,236 <sup>a</sup>	n.a.
Italy	377,270 <sup>a</sup>	133,185 <sup>a</sup>	0 <sup>a</sup>	0 <sup>a</sup>	510,455 <sup>s</sup>	13%
Latvia	0 <sup>a</sup>	0 <sup>a</sup>	0 <sup>a</sup>	0 <sup>a</sup>	0 <sup>a</sup>	n.a.
Lithuania	n.a.	n.a.	n.a.	n.a.	n.a.	n.a.
Luxembourg	62,966 <sup>a</sup>	698 <sup>a</sup>	103 <sup>a</sup>	0 <sup>a</sup>	63,767 <sup>a</sup>	n.a.
Malta	68,500 <sup>a</sup>	119 <sup>a</sup>	381 <sup>a</sup>	0 <sup>a</sup>	69,000 <sup>a</sup>	n.a.
Netherlands	4,424 <sup>a</sup>	1,007 <sup>a</sup>	41 <sup>a</sup>	0 <sup>a</sup>	5,472 <sup>a</sup>	n.a.
Poland	594,418 <sup>a</sup>	2,773 <sup>a</sup>	7,929 <sup>a</sup>	0 <sup>a</sup>	605,120 <sup>s</sup>	n.a.
Portugal	18,843 <sup>a</sup>	0 <sup>a</sup>	0 <sup>a</sup>	0 <sup>a</sup>	18,843 <sup>a</sup>	n.a.
Romania	1,575 <sup>a</sup>	0 <sup>a</sup>	49 <sup>a</sup>	0 <sup>a</sup>	1,624 <sup>a</sup>	n.a.
Slovakia	378 <sup>a</sup>	57 <sup>a</sup>	33 <sup>a</sup>	0 <sup>a</sup>	469 <sup>a</sup>	n.a.
Slovenia	36,996 <sup>a</sup>	14,644 <sup>a</sup>	1,120 <sup>a</sup>	0 <sup>a</sup>	52,759 <sup>a</sup>	n.a.
Spain	465,746 <sup>a</sup>	272,118 <sup>a</sup>	26,932 <sup>a</sup>	0 <sup>a</sup>	764,796 <sup>a</sup>	n.a.
Sweden	42,335 <sup>a</sup>	1,713 <sup>a</sup>	2,150 <sup>a</sup>	0 <sup>a</sup>	46,197 <sup>a</sup>	n.a.
United Kingdom	1,024,677 <sup>a</sup>	28,364 <sup>a</sup>	10,702 <sup>a</sup>	0 <sup>a</sup>	1,063,743 <sup>s</sup>	11%
EU-28	14,105,572	3,402,764	689,873	0	18,198,209	n.a.
Iceland	n.a.	n.a.	n.a.	n.a.	n.a.	n.a.
Norway	n.a.	n.a.	n.a.	n.a.	n.a.	n.a.
Switzerland	n.a.	n.a.	n.a.	n.a.	831,939	n.a.
Methodology:	Sources: (Narodowa Agencja Poszanowania Energii SA NAPE, 2012; Sofia Energy Agency - SOFENA, 2012; Bundesverband des Schornsteinfegerhandwerks – Zentralinnungsverband (ZIV), 2013; Statistik Austria - Bundesanstalt Statistik Österreich, 2013; Bundesverband des Schornsteinfegerhandwerks – Zentralinnungsverband (ZIV), 2014; Budapest University of Technology and Economics, Department of Environmental Economics, 2015; Bundesamt für Statistik BFS, 2015; Danish Energy Agency, 2015; STÚ-K, 2015; ref4e, 2015; Breidenbach and Leers, Frederic (Bundesverband der Deutschen Heizungsindustrie e.V. (BDH)), 2015; van Campenhout, 2015; Energy Economics Group (EEG), 2015; Knezevic, Vanesa (European Heating Industry (EHI)), 2015)					
x = interpolation/ extrapolation						
a = ad hoc calculation						
s = direct use of the source						
m = modelling						



Figure 4: Stock of oil boilers in Europe. Own illustration.



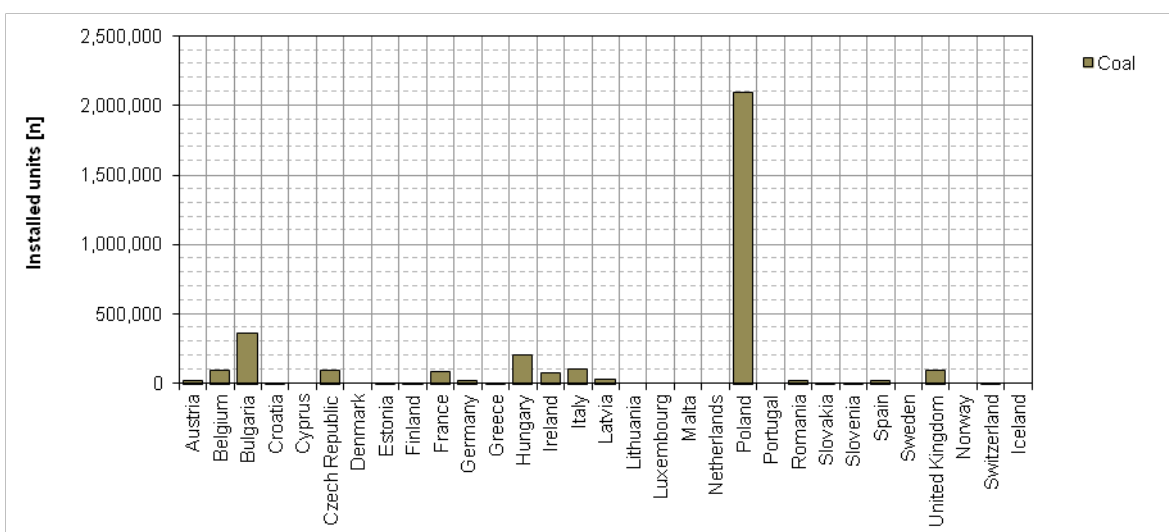
Source: based on sources listed in Table 11

The countries with the largest number of oil boilers installed are Germany, France and Belgium, while there are no units installed in Latvia (for Lithuania no data is available).

Table 12: Stock of coal fired boilers in the EU-28 and Switzerland.

	<25 kW	25 – 100 kW	101 – 250 kW	>250 kW	Total
Austria	8,970 <sup>s</sup>	8,970 <sup>s</sup>	0 <sup>a</sup>	0 <sup>a</sup>	17,940 <sup>s</sup>
Belgium	96,771 <sup>a</sup>	0 <sup>a</sup>	0 <sup>a</sup>	0 <sup>a</sup>	96,771 <sup>s</sup>
Bulgaria	364,759 <sup>a</sup>	13 <sup>a</sup>	65 <sup>a</sup>	0 <sup>a</sup>	364,837 <sup>s</sup>
Croatia	1,828 <sup>a</sup>	42 <sup>a</sup>	7 <sup>a</sup>	0 <sup>a</sup>	1,877 <sup>a</sup>
Cyprus	0 <sup>a</sup>	0 <sup>a</sup>	0 <sup>a</sup>	0 <sup>a</sup>	0 <sup>a</sup>
Czech Republic	92,252 <sup>a</sup>	5,514 <sup>a</sup>	995 <sup>a</sup>	0 <sup>a</sup>	98,761 <sup>s</sup>
Denmark	0 <sup>a</sup>	0 <sup>a</sup>	0 <sup>a</sup>	0 <sup>a</sup>	0 <sup>a</sup>
Estonia	560 <sup>a</sup>	93 <sup>a</sup>	157 <sup>a</sup>	0 <sup>a</sup>	809 <sup>a</sup>
Finland	2,928 <sup>a</sup>	80 <sup>a</sup>	29 <sup>a</sup>	0 <sup>a</sup>	3,037 <sup>a</sup>
France	88,652 <sup>a</sup>	700 <sup>a</sup>	648 <sup>a</sup>	0 <sup>a</sup>	90,000 <sup>s</sup>
Germany	9,762 <sup>s</sup>	9,762 <sup>s</sup>	0 <sup>a</sup>	0 <sup>a</sup>	19,523 <sup>s</sup>
Greece	1,430 <sup>a</sup>	164 <sup>a</sup>	0 <sup>a</sup>	0 <sup>a</sup>	1,594
Hungary	199,448 <sup>a</sup>	10,829 <sup>a</sup>	38 <sup>a</sup>	0 <sup>a</sup>	210,315 <sup>s</sup>
Ireland	73,260 <sup>a</sup>	12 <sup>a</sup>	0 <sup>a</sup>	0 <sup>a</sup>	73,272 <sup>a</sup>
Italy	90,394 <sup>a</sup>	18,501 <sup>a</sup>	0 <sup>a</sup>	0 <sup>a</sup>	108,895 <sup>a</sup>
Latvia	31,251 <sup>a</sup>	0 <sup>a</sup>	202 <sup>a</sup>	12 <sup>a</sup>	31,465 <sup>a</sup>
Lithuania	n.a.	n.a.	n.a.	n.a.	n.a.
Luxembourg	0 <sup>a</sup>	0 <sup>a</sup>	0 <sup>a</sup>	0 <sup>a</sup>	0 <sup>a</sup>
Malta	0 <sup>a</sup>	0 <sup>a</sup>	0 <sup>a</sup>	0 <sup>a</sup>	0 <sup>a</sup>
Netherlands	0 <sup>a</sup>	0 <sup>a</sup>	0 <sup>a</sup>	0 <sup>a</sup>	0 <sup>a</sup>
Poland	1,877,098 <sup>a</sup>	57,529 <sup>a</sup>	164,515 <sup>a</sup>	0 <sup>a</sup>	2,099,142 <sup>s</sup>
Portugal	0 <sup>a</sup>	0 <sup>a</sup>	0 <sup>a</sup>	0 <sup>a</sup>	0 <sup>a</sup>
Romania	25,144 <sup>a</sup>	0 <sup>a</sup>	1 <sup>a</sup>	0 <sup>a</sup>	25,146 <sup>a</sup>
Slovakia	12,632 <sup>a</sup>	193 <sup>a</sup>	110 <sup>a</sup>	0 <sup>a</sup>	12,934 <sup>a</sup>
Slovenia	14 <sup>a</sup>	2 <sup>a</sup>	0 <sup>a</sup>	0 <sup>a</sup>	16 <sup>a</sup>
Spain	11,605 <sup>a</sup>	7,750 <sup>a</sup>	1,142 <sup>a</sup>	0 <sup>a</sup>	20,497 <sup>a</sup>
Sweden	0 <sup>a</sup>	0 <sup>a</sup>	0 <sup>a</sup>	0 <sup>a</sup>	0 <sup>a</sup>
United Kingdom	91,893 <sup>a</sup>	2,544 <sup>a</sup>	960 <sup>a</sup>	0 <sup>a</sup>	95,397 <sup>a</sup>
EU-28	3,080,651	122,697	168,869	12	3,372,229
Iceland	n.a.	n.a.	n.a.	n.a.	n.a.
Norway	n.a.	n.a.	n.a.	n.a.	n.a.
Switzerland	n.a.	n.a.	n.a.	n.a.	1,966
<b>Methodology:</b>	Sources: (Narodowa Agencja Poszanowania Energii SA NAPE, 2012; Sofia Energy Agency - SOFENA, 2012; Bundesverband des Schornsteinfegerhandwerks – Zentralinnungsverband (ZIV), 2013; Statistik Austria - Bundesanstalt Statistik Österreich, 2013; Bundesverband des Schornsteinfegerhandwerks – Zentralinnungsverband (ZIV), 2014; Budapest University of Technology and Economics, Department of Environmental Economics, 2015; Bundesamt für Statistik BFS, 2015; STÚ-K, 2015; Swedish Energy Agency (Westin, Paul), 2015; Giesler, Silke (statista GmbH), 2015; van Campenhout, 2015; Energy Economics Group (EEG), 2015)				
x = interpolation/ extrapolation					
a = ad hoc calculation					
s = direct use of the source					
m = modelling					

Figure 5: Stock of coal fired boilers in Europe.

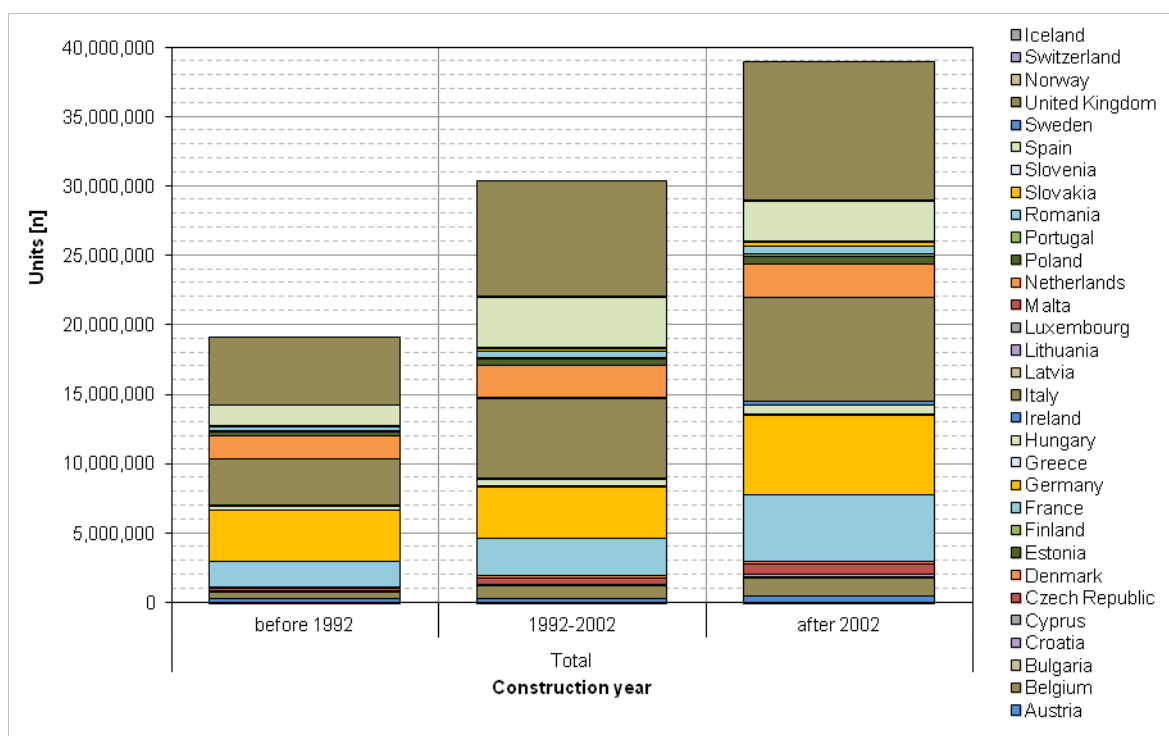


Source: own illustration based on sources listed in Table 12

The country with the by far largest number of coal fired boilers installed is Poland. Other countries with a significant number of installed coal boilers are Bulgaria and Hungary in Eastern Europe followed by Italy, the UK and Belgium. For Lithuania no data is available.

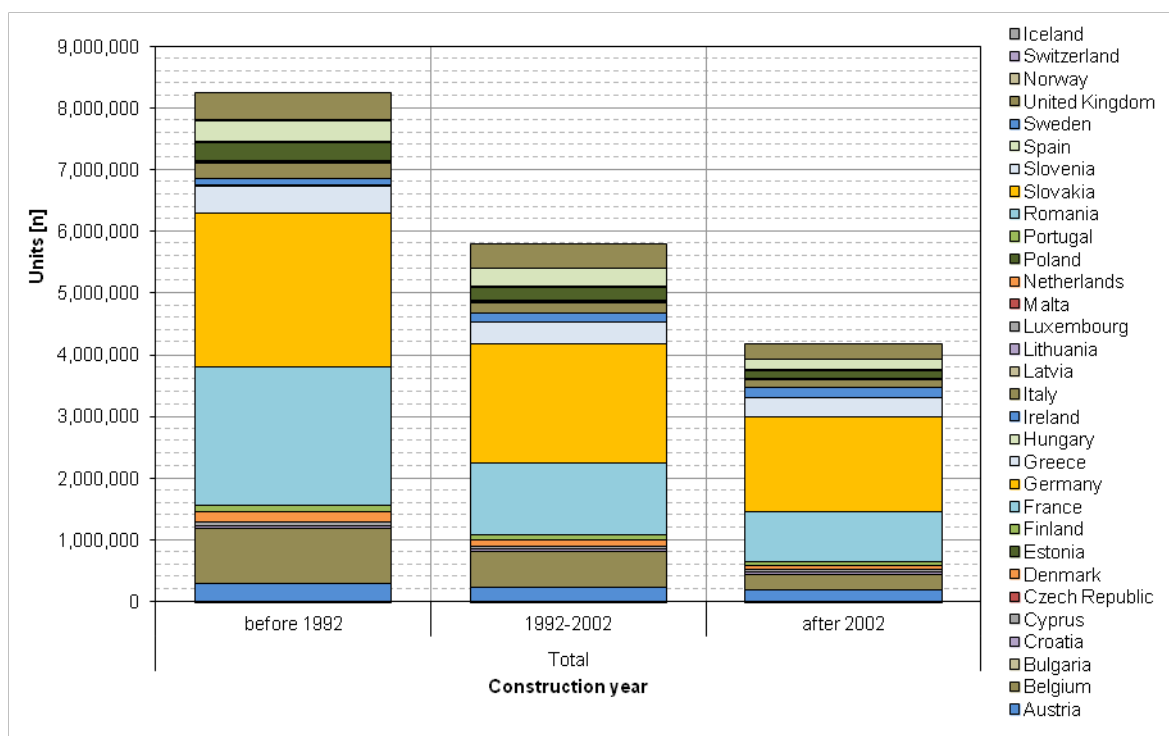
As shown in the tables and figures above, natural gas boilers are more widespread than oil and coal boilers in Europe (approximately 88 M units vs. 18 M oil boilers and 3.4 M coal boilers). The age of the installed units of natural gas, oil and coal boilers is illustrated in Figure 6, Figure 7 and Figure 8 respectively. It can be seen that the role of oil boilers and coal is decreasing as there are many fewer units in the latest age category (installed after 2002) compared to the first age category (installed before 1992). The stock of coal fired boilers is particularly old in comparison, with 58% of all units being installed before 1992 and only 14% after 2002. The age distribution of natural gas boilers is different to the age distributions of oil and particularly coal boilers. There are almost twice as many units less than 10 years old than those older than 20 years. For oil boilers the distribution is vice versa, while the majority of coal fired boilers are older than 20 years, only one seventh is less than 10 years old.

Figure 6: Age distribution of installed units of natural gas boilers in Europe.



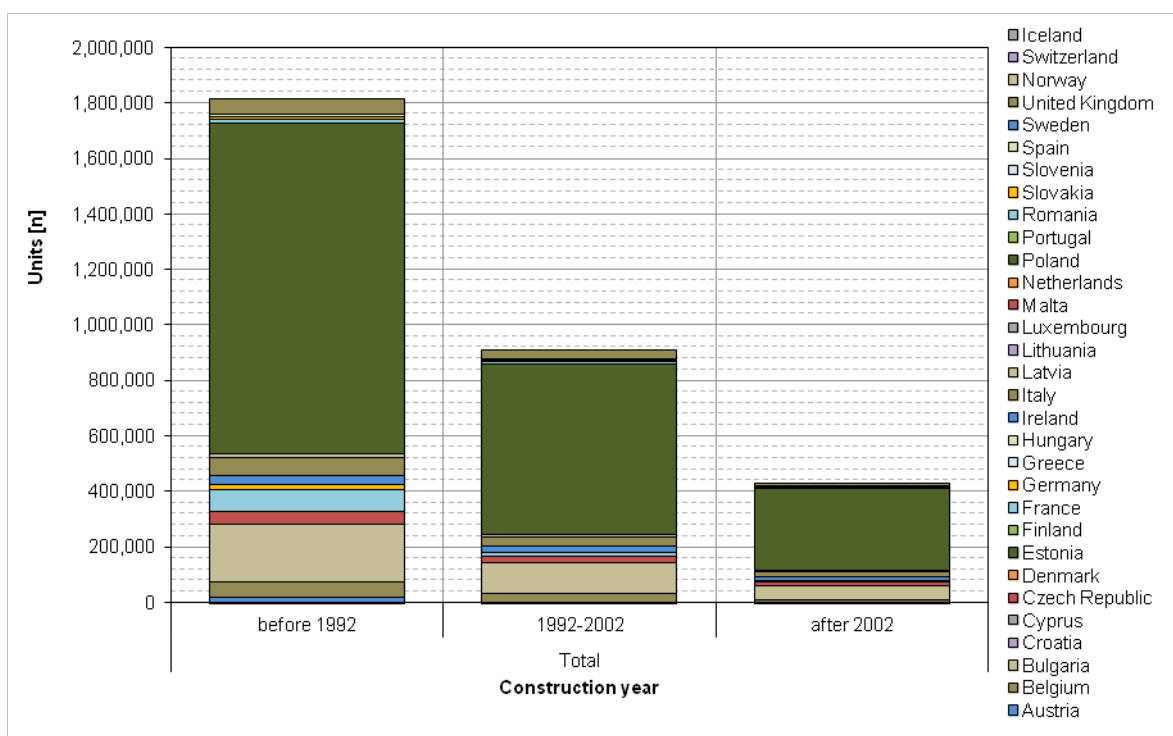
Source: own illustration based on sources listed in Figure 10

Figure 7: Age distribution of installed units of oil boilers in Europe.



Source: own illustration based on sources listed in Figure 11

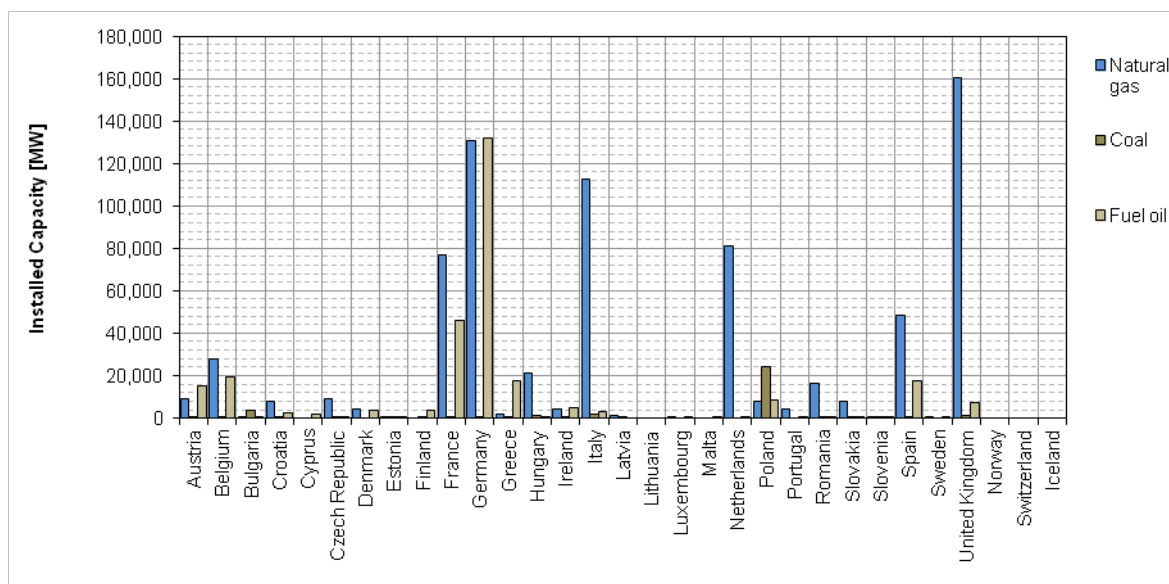
Figure 8: Age distribution of installed units of coal fired boilers in Europe.



Source: own illustration based on sources listed in Table 12.

Figure 9 illustrates the installed capacities of natural gas, oil and coal boilers in the countries investigated. Besides Germany, Austria, Ireland and Poland, the capacity of gas boilers is higher than the capacity of oil boilers in all countries. The important role of natural gas boilers compared with oil boilers can be seen particularly in the UK, Italy and The Netherlands. Only in Poland is the capacity of coal fired boilers higher than the capacity of gas and oil fired boilers

Figure 9: Installed capacity in MW<sub>th</sub> of natural gas, oil and coal boilers by country.



Source: own illustration based on the sources listed in Table 10, Table 11 and Table 12.

Remaining data gaps:

So far, there are no statistics on installed quantities and capacities of oil and natural gas boilers in Lithuania. Furthermore, the statistics of non-member states (Norway, Switzerland and Iceland) are incomplete. The analysis and research into the installed stock of fossil fuel boilers shows that there are no publicly available statistics which include all relevant information such as the distinction of capacity classes and the age of the stock. Furthermore, in most statistics there is no differentiation between condensing and non-condensing boilers. The correspondence with different stakeholders (i.e. industry associations, research and statistical institutes) shows that most stakeholders are willing to deliver as much data as possible and that they would be glad to have detailed information about the heating technology stock in the different countries.

## 2.2 Direct electrical heating systems

### 2.2.1 Scope and description of technology

Decentralised Electrical heating systems usually consist of radiators installed in each room. Rooms can also be equipped with electric floor heating systems, e.g. in bathrooms (c.f. COWI, TI, DGC, 2013). The heat is generated by electric resistances. If an electric system for space heating is installed in a building, the hot tap water is usually also supplied by electric systems; either by hot water tanks with electric heating coils or decentralised electric boilers to avoid long distances between the hot water generation and the tapping point in order to avoid losses and meet hygiene requirements. Older electric radiators have internal thermostats which only regulate the room temperature. Later electric heaters are often equipped with more intelligent technology allowing the programming of temperature schedules for each individual room, the external control of the heating system or even remote internet control (COWI, TI, DGC, 2013).

Radiators can be constructed as storage heaters. Storage heaters can still deliver heat after the electricity is turned off. These systems can generate heat using low electricity prices in periods of high electricity generation and low consumption, and thereby help to balance the electricity grid.

Electric heating systems in buildings usually have a capacity of 5 to 400 kW<sub>th</sub>. District heating systems and large applications have higher capacities of up to 25 MW<sub>th</sub>, but these systems have different configurations (see below). One major advantage of electric heating systems is their flexibility. They can be adjusted from 0 to 100% (and vice versa) very quickly allowing very precise room temperature control (see COWI, TI, DGC (2013)). The reheating of single rooms can also be achieved very quickly and periodic heating (e.g. night setback) is very efficient. Another advantage is that distribution losses are saved as there is no water based heat distribution in the buildings.

The major disadvantages are the loss of exergy, high energy prices and, if electric systems are widespread, there is the danger of congestions in the distribution grid in certain areas (c.f. COWI, TI, DGC, 2013).

Large electric boilers, which are mainly used in district heating systems, differ from the systems used in single buildings. Smaller applications with a thermal capacity of 1-2 MW<sub>th</sub> use electrical resistance for the generation of heat and are technically similar to the applications in buildings described above (see COWI, TI, DGC (2012)). Larger boilers are constructed as electrode boilers. The electrode systems consist of three-phase electrodes and one neutral electrode. Power is fed to the electrodes and the current flows directly through the water thus heating it (COWI, TI, DGC (2012)). Electrode boilers can be controlled between 10-20% and 100% of the nominal load by moving a motor-driven gear shaft up and down the electrodes. The technology characterisation of large electric boilers, mainly connected to district heating systems, can be found in chapter 3.6.

Potentially, electric heating systems can be operated with 100% renewable energy if all electricity is generated from renewable sources. Thereby, the environmental impact (i.e. associated greenhouse gas emissions) is highly dependent on the electricity mix in the area/ country concerned.

There will not be any major improvements in the thermal efficiency of the systems in the future. The integration of smart grids and the grid-interactivity of direct electric heating, however, may lead to positive technology developments and improvements (see COWI, TI, DGC, 2013).

The values described in the following paragraphs are for a whole system of space

heating and hot water generation in buildings.

There is hardly any data on the number of installed units. Data from national statistics on installed heating units and in building typologies is usually only available on the number of buildings heated with direct electric heating systems. Furthermore, data on heating systems is usually only available for the residential buildings and, to a certain extent, for non-residential buildings. As mentioned above there is usually one electric radiator in each room, but there is no information on the number of rooms in buildings equipped with direct electric heating systems. Even in countries with a high proportion of electrical heating systems, like France and Norway, the data availability is very low.

For the stock distribution in Table 15 only data on the number of buildings is presented. The total number of units differs from the numbers presented. The data is retrieved from national statistics if available. If there was no data available from national statistics data from building typologies was used. Additional calculations were carried out based on the INVERT/ EE-Lab results concerning the age distribution and subdivision into capacity classes (Energy Economics Group (EEG), 2015) as described above.

Direct electric heating systems comprise a share of 11% in the installed technology stock (units) and 13% in the total installed capacity.

### 2.2.2 Technology characterisation

In the following, electric boilers are characterised in terms of their thermal efficiency, the technical lifetime, and the specific investment and operation and maintenance (O&M) costs. The values are given for different capacity classes and possible developments up to 2030 are described.

In Table 13 the thermal efficiency of the boilers is listed. The values given are based on COWI, TI, DGC (2013) and Wenzel et al. (2010). As the boiler market is international and the major manufacturers are selling their products all over Europe it is assumed that the given efficiencies are achieved in all countries analysed in this study. As electric boilers are an established and widespread technology no major efficiency increases are expected by 2030. The only major developments expected are those providing the ability to interact with the electricity grid and the ability to balance the grid (integration into smart grids).

Table 13: Thermal efficiency of electric boilers in %.

Source	<25 kW <sub>th</sub>	25 – 100 kW <sub>th</sub>	101 – 250 kW <sub>th</sub>	251 – 400 kW <sub>th</sub>
COWI, TI, DGC (2013)	100	n.a.	n.a.	95
Wenzel et al. (2010)	96	96	100	100

Source: the values given are based on Wenzel et al. (2010) and COWI, TI, DGC (2013)

The technical lifetime of electric heating systems in buildings is 30 years (c.f. COWI, TI, DGC, 2013). Larger boilers with a thermal capacity of up to 25 MW<sub>th</sub> used in district heating systems have a shorter lifetime of 20 years (see COWI, TI, DGC, 2012). As mentioned above the boiler market is international. Therefore, the same technical lifetime is assumed for all countries investigated.

In Connolly et al. (2013) cost data for different boilers in all European countries except Croatia, Iceland, Norway and Switzerland, are given, although they are not provided for direct electric heating systems. As the cost data for direct electric systems given in Wenzel et al. (2010) seems to be very low compared to the data given in COWI, TI, DGC (2013) and the range of 350 – 450 €/kW (including heater, installation and con-



trol unit) for storage heaters presented in Schramek (2011), the cost data in Wenzel et al. (2010) are not considered in this study. For the values presented in Table 14 the cost data from Denmark given in COWI, TI, DGC (2013) are used and extrapolated for the other Member States using the country factors from BKI (2011) following the methodology used in the Heat Roadmap Europe (Connolly et al., 2013). In COWI, TI, DGC (2013) only costs for systems with 5 kWth and 400 kWth are given. For the capacity classes “25 – 50 kWth” and “51 – 250 kWth” these costs were interpolated linearly. Due to the fact that electric heating systems are an established technology (see above) it is not expected that the investment and O&M costs will be reduced until 2030 (c.f. COWI, TI, DGC, 2012, ; COWI, TI, DGC, 2013; Wenzel et al. 2010).

Table 14: Specific investment costs in €/kW<sub>th</sub> of electric heating systems in buildings in the EU27.

	<25 kW	25 – 100 kW	101 – 250 kW	251 – 400 kW
Austria	654	645	613	543
Belgium	532	525	499	442
Bulgaria	243	240	228	202
Croatia	n.a.	n.a.	n.a.	n.a.
Cyprus	401	396	376	334
Czech Republic	355	350	333	295
Denmark	800	789	750	665
Estonia	383	378	359	319
Finland	586	578	550	487
France	641	632	601	533
Germany	647	638	607	538
Greece	391	386	367	325
Hungary	333	329	313	277
Ireland	553	546	519	460
Italy	426	420	399	354
Latvia	447	441	419	372
Lithuania	398	393	373	331
Luxembourg	551	544	517	458
Malta	347	342	325	288
Netherlands	693	684	650	576
Poland	384	379	360	319
Portugal	319	315	299	265
Romania	247	243	231	205
Slovakia	375	370	351	312
Slovenia	409	403	384	340
Spain	441	435	414	367
Sweden	780	769	731	648
United Kingdom	627	618	587	521

Source: based on the values for Denmark given in COWI, TI, DGC (2013) and extrapolated to the other Member States following the methodology of Connolly et al. (2013) for the EU27. Country factors for Croatia, Iceland, Norway and Switzerland could not be derived from this source

According to Wenzel et al. (2010) and COWI, TI, DGC (2013) O&M costs are between 0 and 0.1%. The main reason for this is that there are no engines or moving parts and no fuel is burned. In addition, the electrical elements in the heating systems are long-lasting. Large scale heaters in district heating systems have higher O&M costs of 1 to 2% as the electrical elements are less accessible, and in the case of electrode boilers there are more moving parts (c.f. COWI, TI, DGC, 2012).

### **2.2.3 Technology stock distribution**

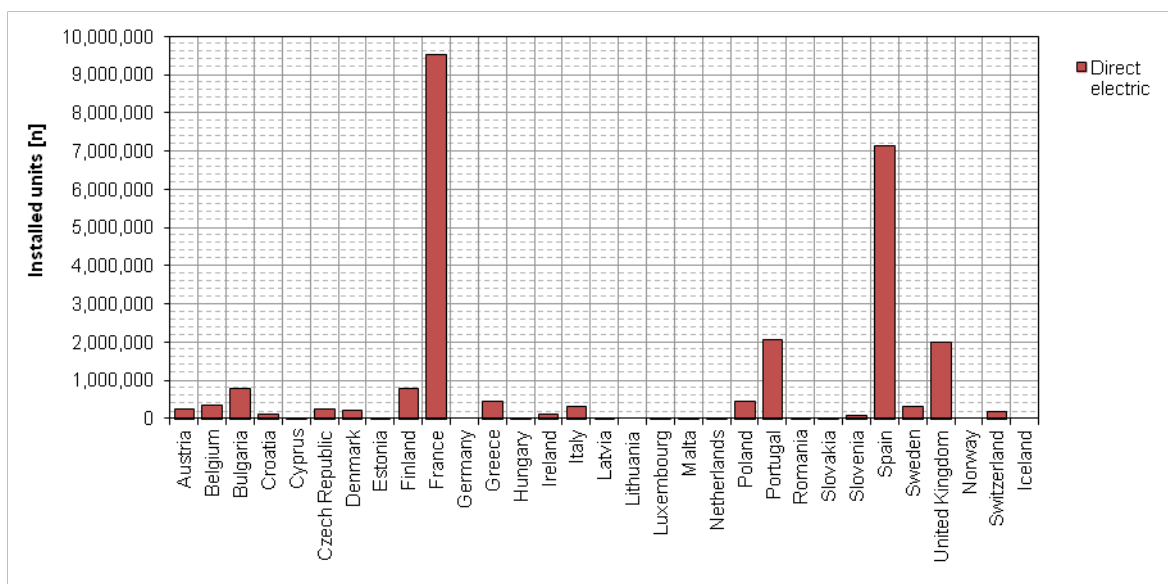
The use of direct electric heating is highly dependent on the energy sources and energy policy of the Member States. For example storage heaters were, and still are used in countries with a high proportion of nuclear power in the electricity production as surplus electricity generated during the night can be utilised by storing the heat. Storage heaters have thereby helped to stabilise electricity grids (e.g. France). Direct electric heating is also widespread in countries which have significant electricity generation from hydro-power (e.g. Norway). Another application of direct electric heating systems is in countries where there are only a few cold days during winter and/ or no connection to gas pipelines. In such countries the installation of a water-based heating system with boilers is too expensive and the degree of utilisation would be very low. In these countries the installation of decentralised and cheap electric heating systems can be the most cost-effective heating technology. The technology stock distribution (installed units) in the countries investigated is shown in Table 15.

In 2012 approximately 25 M units with an overall capacity of 228 GW<sub>th</sub> were installed in the EU-28, not including Germany and Lithuania as there are no stock data available in these countries. The greatest number of installed units are in the smallest capacity category (<25 kW<sub>th</sub>) (approx. 21.5 M) which also provide the largest share of installed capacity (approx. 167 GW<sub>th</sub>). The countries with the largest number of installed units and the largest installed capacity are France, Spain, Portugal and the UK (see also Figure 10 and Figure 11). Most electric heating systems were installed between 1992 and 2002 (35% relating to installed units) and before 1992 (34% relating to installed units). The age distribution is illustrated in Figure 12.

Table 15: Stock of direct electric heating systems in the EU-28 and Switzerland.

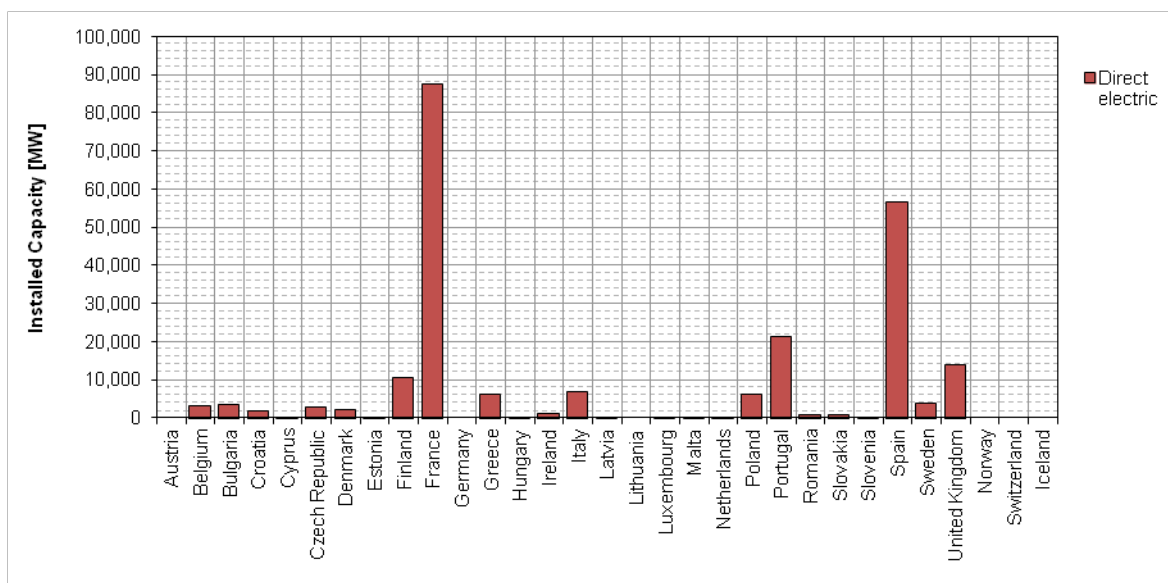
	<25 kW	25 – 100 kW	101 – 250 kW	>250 kW	Total
Austria	n.a.	n.a.	n.a.	n.a.	237,541 <sup>s</sup>
Belgium	258,338 <sup>a</sup>	24,025 <sup>a</sup>	41,571 <sup>a</sup>	0 <sup>a</sup>	323,934 <sup>s</sup>
Bulgaria	703,075 <sup>a</sup>	10,187 <sup>a</sup>	49,424 <sup>a</sup>	0 <sup>a</sup>	762,686 <sup>s</sup>
Croatia	87,268 <sup>a</sup>	1,979 <sup>a</sup>	337 <sup>a</sup>	0 <sup>a</sup>	89,584 <sup>a</sup>
Cyprus	9,366 <sup>a</sup>	932 <sup>a</sup>	92 <sup>a</sup>	0 <sup>a</sup>	10,390 <sup>s</sup>
Czech Republic	235,001 <sup>a</sup>	6,306 <sup>a</sup>	1,138 <sup>a</sup>	0 <sup>a</sup>	242,444 <sup>s</sup>
Denmark	207,723 <sup>a</sup>	836 <sup>a</sup>	109 <sup>a</sup>	0 <sup>a</sup>	208,669 <sup>a</sup>
Estonia	7,051 <sup>a</sup>	1,182 <sup>a</sup>	1,973 <sup>a</sup>	0 <sup>a</sup>	10,206 <sup>a</sup>
Finland	767,272 <sup>a</sup>	14,222 <sup>a</sup>	2,594 <sup>a</sup>	0 <sup>a</sup>	784,088 <sup>a</sup>
France	8,991,050 <sup>a</sup>	264,187 <sup>a</sup>	244,763 <sup>a</sup>	0 <sup>a</sup>	9,500,000 <sup>s</sup>
Germany	n.a.	n.a.	n.a.	n.a.	n.a.
Greece	430,308 <sup>a</sup>	1,270 <sup>a</sup>	0 <sup>a</sup>	0 <sup>a</sup>	431,578 <sup>a</sup>
Hungary	4,104 <sup>a</sup>	228 <sup>a</sup>	12 <sup>a</sup>	0 <sup>a</sup>	4,344 <sup>s</sup>
Ireland	91,787 <sup>a</sup>	808 <sup>a</sup>	0 <sup>a</sup>	0 <sup>a</sup>	92,595 <sup>a</sup>
Italy	176,345 <sup>a</sup>	125,167 <sup>a</sup>	0 <sup>a</sup>	0 <sup>a</sup>	301,513 <sup>a</sup>
Latvia	1,336 <sup>a</sup>	0 <sup>a</sup>	79 <sup>a</sup>	6 <sup>a</sup>	1,421 <sup>a</sup>
Lithuania	n.a.	n.a.	n.a.	n.a.	n.a.
Luxembourg	7,691 <sup>a</sup>	66 <sup>a</sup>	10 <sup>a</sup>	0 <sup>a</sup>	7,767 <sup>a</sup>
Malta	31,808 <sup>a</sup>	61 <sup>a</sup>	196 <sup>a</sup>	0 <sup>a</sup>	32,065 <sup>a</sup>
Netherlands	3,482 <sup>a</sup>	1,371 <sup>a</sup>	94 <sup>a</sup>	0 <sup>a</sup>	4,948 <sup>a</sup>
Poland	416,486 <sup>a</sup>	5,728 <sup>a</sup>	16,278 <sup>a</sup>	0 <sup>a</sup>	438,493 <sup>s</sup>
Portugal	2,047,901 <sup>a</sup>	0 <sup>a</sup>	0 <sup>a</sup>	0 <sup>a</sup>	2,047,901 <sup>a</sup>
Romania	49,281 <sup>a</sup>	0 <sup>a</sup>	822 <sup>a</sup>	0 <sup>a</sup>	50,102 <sup>a</sup>
Slovakia	39,038 <sup>a</sup>	70 <sup>a</sup>	41 <sup>a</sup>	0 <sup>a</sup>	39,149 <sup>a</sup>
Slovenia	45,899 <sup>a</sup>	18,168 <sup>a</sup>	1,393 <sup>a</sup>	0 <sup>a</sup>	65,459 <sup>s</sup>
Spain	4,652,115 <sup>a</sup>	2,369,101 <sup>a</sup>	99,429 <sup>a</sup>	0 <sup>a</sup>	7,120,646 <sup>s</sup>
Sweden	287,611 <sup>a</sup>	1,069 <sup>a</sup>	1,326 <sup>a</sup>	0 <sup>a</sup>	290,006 <sup>a</sup>
United Kingdom	1,923,527 <sup>a</sup>	55,524 <sup>a</sup>	20,950 <sup>a</sup>	0 <sup>a</sup>	2,000,000 <sup>s</sup>
EU-28	21,474,864	2,902,488	482,630	6	25,097,529
Iceland	n.a.	n.a.	n.a.	n.a.	n.a.
Norway	n.a.	n.a.	n.a.	n.a.	n.a.
Switzerland	n.a.	n.a.	n.a.	n.a.	167,260
Methodology:	Sources: (IDAE, 2011; Narodowa Agencja Poszanowania Energii SA NAPE, 2012; Sofia Energy Agency - SOFENA, 2012; Statistik Austria - Bundesanstalt Statistik Österreich, 2013; Gradbeni inštitut ZRMK d.o.o., 2014; Budapest University of Technology and Economics, Department of Environmental Economics, 2015; Giesler, Silke (statista GmbH), 2015; Building Research Establishment Ltd (Mr. Jack Hulme), 2015; van Campenhout, 2015; Energy Economics Group (EEG), 2015)				
x = interpolation/ extrapolation					
a = ad hoc calculation					
s = direct use of the source					
m = modelling					

Figure 10: Stock of direct electric heating systems in Europe. Data is not available for Germany, Lithuania, Norway and Iceland.



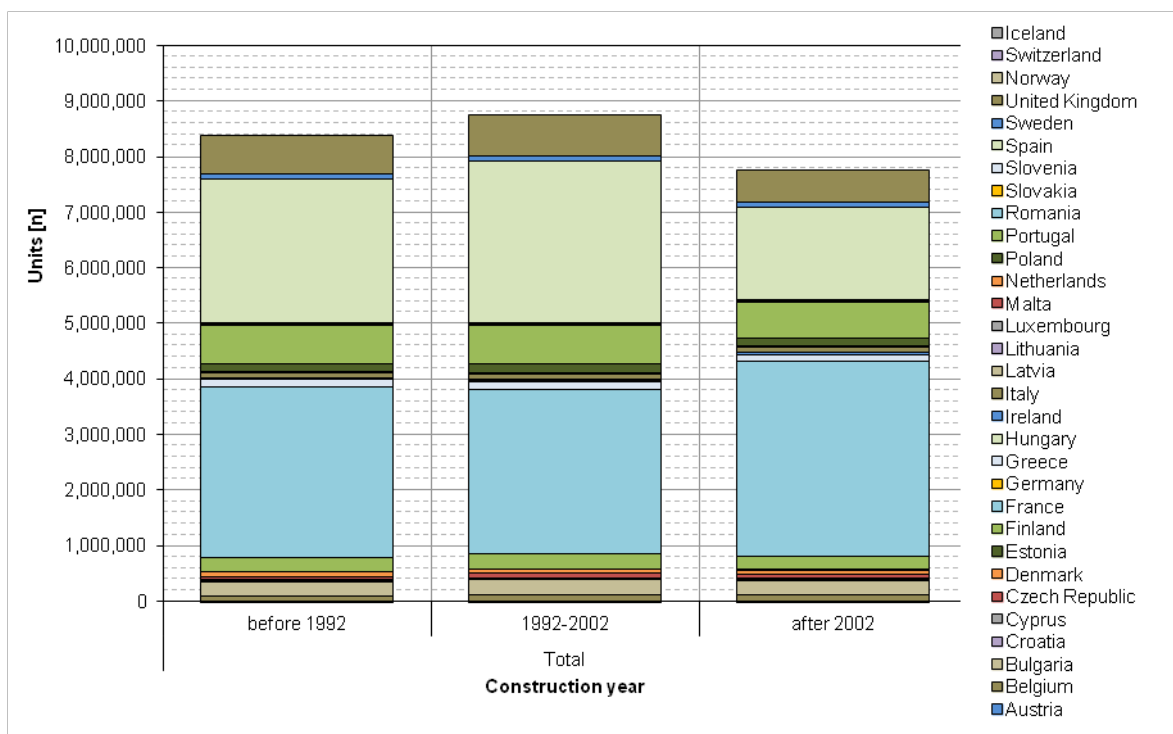
Source: own illustration based on sources listed in Table 15

Figure 11: Installed capacity in MW<sub>th</sub> of direct electric heating systems by country. Data is not available for Germany, Lithuania, Norway, Switzerland and Iceland.



Source: own illustration based on the sources listed in Table 15

Figure 12: Age distribution of installed units of direct electric heating systems in Europe.



Source: own illustration based on sources listed in Table 15

Statistics on the installed number of units and capacities in different capacity and age categories are not available in the examined countries. Furthermore, there are no statistics on the installed stock available for Germany, Lithuania, Norway, Switzerland and Iceland.

## 2.3 Combined heat and power technologies

### 2.3.1 Scope and description of technology

Combined heat and power generation (CHP) is seen as an important element to achieve the EU's greenhouse gas (GHG) emission reduction targets. This is because heat for space heating and hot tap water, as well as electricity, are generated simultaneously leading to a higher degree of utilisation of the fuels (fossil/ renewable) than with separate heat and electricity generation. Many Member States have development goals for CHP in their electricity generation and heat supply. An overview of existing and possible future CHP-technologies, with their typical electric capacities and efficiency is given in Table 16.

Table 16: Overview over current and future CHP technologies. The values given reflect current state of the art units.

	Capacity range [MW <sub>el</sub> ]	Net electrical efficiency [%]	Total efficiency [%]
Gas turbine	0.1-150	29-36	80-85
Micro gas turbine	0.03-0.2	25-30	80-85
CCGT (backpressure)	20-500	35-40	80-90
CCGT (extraction)	20-500	35-60	80-92
Steam turbine (backpressure)	5-200	25-35	80-90
Steam turbine (extraction)	50-800	33-45	55-92
Stirling-engine	0.001-0.04	15-30	80-85
Fuel cell (PEM/ PAFC)	0.002-1	35-45	85-95
High temperature fuel cell (MFC/ SOFC)	0.001-500	50-65	85-95
Organic-Rankine-Cycle (ORC)	0.01-2	10-20	70-80
Internal combustion engine (IC)	0.001-10	20-45	82-95
Diesel engine	0.001-10	40-45	85-98
Solid biomass, CHP-ORC	> 0.5	13	84
Solid biomass, IC-wood distillation	0.03 - 2	18-40	63-85 (el./th.); 75 (wood distillation)
Solid biomass, CHP- Steam-turbine	2-10	15-25	84-85
Biogas-IC	< 1	27-39	79-91
Vegetable oil-CHP	0.005-5	29-41	90-91

Source: Wenzel et al. (2010), Volz (2012), E.ON SE, Erdmann and Dittmar (2010), UBA (2013), COWI, TI, DGC (2013). Large applications usually have a higher electrical efficiency (upper value given in efficiency range) than small applications (lower value given in efficiency range)

Some of the technologies, such as steam turbines or CCGT, are primarily used in large scale installations such as district heating systems. Other technologies have just been introduced onto the market and are not widespread (still in the research and/ or introduction phase in Europe). Therefore, not all of the listed CHP-technologies are relevant for the building sector and are therefore not considered in this document which only

describes and characterises the following technologies:

- Cogeneration internal combustion (CHP-IC), gas-fired
- Stirling engine
- Fuel cell

### **Cogeneration internal combustion (CHP-IC)**

Internal combustion engines are the most widespread CHP technology for decentralised application in buildings. The following short description is based on COWI, TI, DGC (2013).

CHP-ICs are mainly based on conventional gas engines, which are piston engines where the fuel-air-mix is burnt inside the cylinder. The fuel-air-mix is compressed by the piston and then ignited (spark ignition). Through combustion, the fuel and gas expand and move the piston, which runs a generator to produce electricity. The movement also leads to the compression of the fuel-air-mix in another cylinder. The exhaust air and the engine itself have to be cooled, which is usually achieved with a water-cooling system. The heated water can then be used for heating purposes. The units are delivered in noise insulated cabinets.

Most micro and mini CHP-ICs are four-stroke water cooled engines, but some very small units (~1 kW<sub>el</sub>) only have one cylinder. Larger applications of more than 300 kW<sub>el</sub> also have a turbo charger. Micro CHP engines currently have an efficiency of approximately 20% and mini CHP-ICs of 28% to 36%.

Usually, CHP-ICs are fuelled by natural gas, but there are also engines that are fuelled by heating oil, LPG or biogas. Typical capacities for the application in buildings (space heating, hot tap water) are 3 to 300 kW<sub>th</sub> and 1 to 180 kW<sub>el</sub>. CHP-ICs are also available for district heating networks or production sites with much higher capacities of several MW<sub>el</sub>.

The main advantages of the technology are their fast start-up and ability to operate at part-load (with some efficiency decreases). Furthermore, gas engines are an established technology and if operated as electricity driven (contrary to heat driven, which is the usual operation mode in buildings), they can help stabilise the electricity grid. They are also long lasting, have only few high-tech components and are reasonably efficient. Disadvantages are the comparably high O&M-costs, high emissions and some level of noise.

In the past, research focused on increasing the electrical efficiency, reducing the emissions, and on the catalyst system and these will most likely be the fields of development in the near future.

As decentralised CHP-plants are not very widespread, the acquisition of reliable data was difficult and in many cases impossible. Furthermore, the dissemination of small scale CHP units is relatively new. Therefore, detailed information about the sector is unavailable from most international statistics (e.g. from the International Energy Agency IEA) or it is impossible to extract reliable information from large electricity plant databases such as the PLATTS database (Bergesen, 2014). If there are support mechanisms installed in a country, there is usually data on the number of installed units, but, except for Germany, it was impossible to find data on installed units and capacities in different capacity and age categories. Another data source was The European Association for the Promotion of Cogeneration (COGEN Europe). According to Duvielguebigny, Arnaud (Cogen Europe) (2015) COGEN Europe does also not have the information collected in this project. It was mainly the information from Germany (Bundesamt für Wirtschaft und Ausfuhrkontrolle BAFA, 2014) and some data provided by COGEN Europe (COGEN Europe, 2013), and Duvielguebigny, Arnaud (Cogen Eu-

rope, 2015) that was used for the data presented below. Since only limited data was available, a disaggregation based on the research and the model results (INVERT/ EE-Lab) was not carried out as it was done for other heating technologies.

### Stirling engine

Stirling engines (hot air engines) are piston engines where in contrast to internal combustion engines the combustion takes place outside the cylinder (COWI, TI, DGC, 2013). The driving force of the engine is a temperature difference resulting from external heating and cooling sources. As a result, there is one permanently hot and one cold part in the engine. The fact that the combustion takes place outside the cylinder allows the use of different types of fuel. Most small scale applications in buildings are fuelled by natural gas, but they could also be fuelled by LPG, fuel oil or biogas. Larger installations can also use solid biomass or waste (c.f. COWI, TI, DGC, 2013). It is expected that gas fuelled Stirling engines will be the most realistic option in the near future as biomass fuelled engines are too large for single- and most multi-family buildings (COWI, TI, DGC, 2013).

Stirling engines are operated with a working gas, which can be helium or pressurised air. On the hot side of the engine the gas is heated and expands, pushing a working piston. The movement of the piston results in the movement of a displacement piston forcing the working gas to the cold side of the engine. There the gas cools down and contracts. The cooling of the working gas releases heat which can be used for space heating and hot tap water. The piston movement is transferred to a generator for electricity generation.

Even though the principle of Stirling engines is relatively old (invented in 1816), the engines did not have their major commercial breakthrough at this point (COWI, TI, DGC, 2013). There are several engines available from different companies, but they all play a minor role in the CHP market (decentralised applications). Engines that are currently available have an electrical efficiency of approximately 25% (larger applications) and 12% (smaller engines). Small applications have a capacity of 1 to 7 kW<sub>el</sub> and 7 to 15 kW<sub>th</sub>. Large engines currently have capacities of up to 120 kW<sub>th</sub> and 37 to 40 kW<sub>el</sub> (COWI, TI, DGC, 2013).

Advantages of Stirling engines are the simple principle and the ability to rapidly regulate the thermal output. However, the electrical output can only be regulated comparatively slowly. Furthermore the engines fuelled by natural gas have low emissions, vibrations and service requirements, as well as low capital costs and a relatively long technical lifetime (COWI, TI, DGC, 2013). Disadvantages arise from the high pressure needed for operation (approximately 80 bars). This results in difficulties concerning the durability of heat exchangers and the tightening of the engines (see COWI, TI, DGC (2013)). Furthermore, the engines have long start up times and relatively high start-up energy consumption. Additionally, the ability to operate at part-load is limited (COWI, TI, DGC, 2013).

Research activities largely focus on the electrical efficiency, durability of the heat exchangers and tightening of the engine. The values presented below refer to the Stirling engine itself excluding other installations needed such as heat or fuel storages.

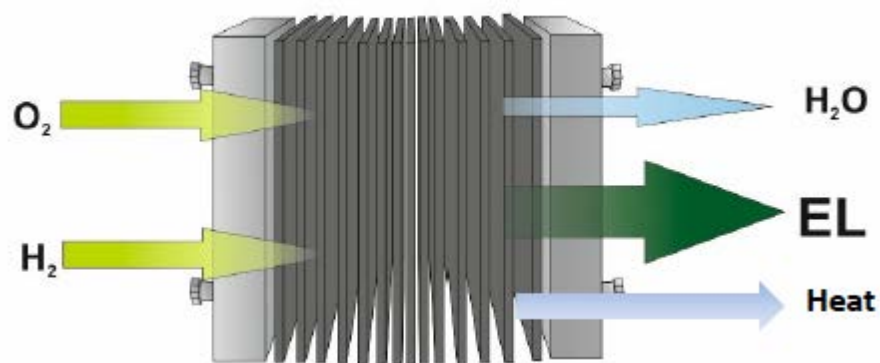
### Fuel cell

Fuel cells are still in the launch phase in Europe and only demonstration plants have been installed. In Japan, the technology is already penetrating the heat market with more than 100,000 installed hydrogen fuel cells in households until 2014 (Watanabe, 2015). So far, they don't play an important role in Europe's heat and electricity generation, but they are a promising technology for the future.



In fuel cells, electricity and heat are produced through an electrochemical reaction between the fuel and oxygen used. Both hydrogen and oxygen are needed for the reaction but each can come from a different source, for example hydrogen reformation from natural gas and oxygen from the ambient air. The schematic functionality is shown in Figure 13. Compared to other CHP-technologies in buildings, fuel cells have the potential to obtain higher electrical conversion efficiency in the same power ranges (COWI, TI, DGC, 2013). There are different types of fuel cells such as PEM (Proton Exchange Membrane) and SOFC (Solid Oxide Fuel Cell). Furthermore, fuel cells operate at different temperature levels.

Figure 13: Schematic principle of a fuel cell stack.



Source: COWI, TI, DGC (2013)

By combining several fuel cell stacks the power of a fuel cell CHP can be scaled up without major efficiency losses (COWI, TI, DGC, 2013). Typically, fuel cell CHPs are equipped with a heat storage in order to limit the capacity of the fuel cell (prices are still very high). The combination with storage tanks also allows electricity prices/electricity demand to be followed, and so fuel cell CHPs can help to balance the electricity grid at a local level. Fuel cells deliver direct current (DC). Therefore additional DC/AC (alternating current) inverters are needed.

The ability to regulate is highly dependent on the way hydrogen is supplied. While the regulation ability of reformers is limited, fuel cells supplied with hydrogen from onsite electrolyzers connected with hydrogen storage can react very quickly and their ability to balance local electricity grids is higher. However, due to their efficiency and lifetime, fuel cells should be operated at nominal power and part-load should be avoided (see (COWI, TI, DGC, 2013)).

Fuel Cell CHPs can be supplied with different fuels. If natural gas is used they can be easily connected to existing gas grids. The fuel cell itself needs hydrogen as input and therefore an additional reformer (either internal or separate) is needed. Hydrogen can also be supplied from electrolyzers using electricity to generate the levels needed. If it is to be provided centrally, hydrogen distribution networks are needed. If it is generated locally in single buildings, each building needs an electrolyser and hydrogen storage in order to be able to decouple the hydrogen production from the heat and electricity generation in the fuel cell. Electrolysers currently have an efficiency of approximately 85 % (COWI, TI, DGC (2013)).

The environmental impact of fuel cells mainly depends on the fuel used for the production of hydrogen. If the hydrogen is produced in electrolyzers there are no onsite CO<sub>2</sub> emissions and the only emission is water. When the fuel cell is supplied with natural

gas there are CO<sub>2</sub> and water emissions onsite (c.f. COWI, TI, DGC, 2013).

Potentially, fuel cells can be supplied with biogas, but some components like hydrogen sulphide have to be removed. Electrolysers use electricity for the production of the hydrogen and can therefore use 100% renewable energies without any technical problems. The system consisting of electrolyser, hydrogen storage and fuel cell can chemically store surplus electricity from renewable sources.

The values (costs, efficiency, lifetime etc.) presented below refer to the fuel-cell CHP. Possible additional costs for onsite electrolysers or reformers are not taken into account, but are indicated as percentage of the costs of the fuel cells.

As mentioned above, fuel cells are still in the demonstration phase in Europe. Therefore they do not yet appear in national statistics. Furthermore, the low quantity and capacity of demonstration plants are not significant today, but they have the potential to play a larger role in the future.

### **2.3.2 Technology characterisation**

#### **Cogeneration internal combustion (CHP-IC)**

According to COWI, TI, DGC (2013) and ASUE (2011) internal combustion engines currently have a thermal efficiency of 22 – 65% and an electrical efficiency of 20 – 49%. In the coming years overall efficiencies of 95 – 100% are expected (COWI, TI, DGC, 2013).

The cost data shown in Table 17 is based on ASUE (2011) and extrapolated for the other Member States as described in chapter 2.2. The cost data in ASUE (2011) is given for the year 2010 and adjusted to 2012 using German inflation rates. As CHP-ICs are an established technology it is unlikely that there will be major cost decreases in the future for CHP-ICs with an electrical capacity of more than 25 kW<sub>el</sub>. According to COWI, TI, DGC (2013) the costs for small micro CHP-ICs are expected to fall by 20% by 2020 and by one third by 2030 compared with the costs in 2012.

Annual operation and maintenance costs account for approximately 2% of the investment costs (c.f. International Energy Agency (2010)). It has to be mentioned, that the O&M costs can vary, especially for small systems.

The technical lifetime of CHP-ICs is about 15 - 25 years for small engines with up to 100 kW<sub>el</sub> and 15 to 20 years for larger units (International Energy Agency, 2010).

Table 17: Specific investment costs in €/kW<sub>el</sub> of internal combustion engines (CHP-IC) in buildings in the EU27.

	<25 kW <sub>el</sub>	25 – 100 kW <sub>el</sub>	101 – 250 kW <sub>el</sub>	251 – 1000 kW <sub>el</sub>	1001 – 4999 kW <sub>el</sub>
Austria	1,981	1,265	690	371	187
Belgium	1,612	1,029	562	302	152
Bulgaria	737	471	257	138	70
Croatia	n.a.	n.a.	n.a.	n.a.	n.a.
Cyprus	1,216	776	424	228	115
Czech Republic	1,075	686	374	201	102
Denmark	2,424	1,548	844	454	229
Estonia	1,161	741	404	217	110
Finland	1,777	1,135	619	333	168
France	1,941	1,240	676	363	183
Germany	1,870	1,650	890	500	240
Greece	1,184	756	413	222	112
Hungary	1,010	645	352	189	95
Ireland	1,677	1,071	584	314	158
Italy	1,290	824	450	242	122
Latvia	1,355	865	472	254	128
Lithuania	1,206	770	420	226	114
Luxembourg	1,671	1,067	582	313	158
Malta	1,051	671	366	197	99
Netherlands	2,100	1,341	732	393	198
Poland	1,163	743	405	218	110
Portugal	967	617	337	181	91
Romania	747	477	260	140	71
Slovakia	1,135	725	396	213	107
Slovenia	1,239	791	432	232	117
Spain	1,337	854	466	250	126
Sweden	2,363	1,509	823	442	223
United Kingdom	1,898	1,212	661	355	179

Source: based on ASUE (2011), adjusted to 2012 and extrapolated to the other Member States following the methodology of Connolly et al. (2013) for the EU27. Country factors for Croatia, Iceland, Norway and Switzerland could not be derived from this source.

In Table 18 the thermal and electrical efficiency ranges of internal combustion engines (CHP-IC) are listed. The values given are based on COWI, TI, DGC (2013), ASUE,(2011) and International Energy Agency (2010). As the market for CHP-ICs is international and the major manufacturers are selling their products all over Europe it is assumed that the given efficiencies are achieved in all countries analysed in this study. The given ranges reflect the fact that the efficiency of CHP-ICs is highly dependent on the mode of operation (part load/ full load), the actual size of the units (installed electrical power) and the thermal load profile of the buildings in which the units are installed.

As mentioned above, CHP-ICs are an established technology. Nevertheless, it is expected that the electrical, thermal and total efficiency can be increased in the coming years. Expected developments are shown in Table 19.

Table 18: Thermal and electrical efficiency of internal combustion engines (CHP-IC) in %.

Source	<25 kW <sub>el</sub>	25 – 100 kW <sub>el</sub>	101 – 250 kW <sub>el</sub>	251 – 1000 kW <sub>el</sub>	1001 – 4999 kW <sub>el</sub>
<b>Electrical efficiency</b>					
(COWI, TI, DGC, 2013)	20-36	28-36	28-36	28-36	28-36
(ASUE, 2011)	25-46				
(International Energy Agency, 2010)	20-40		30-40		
<b>Thermal efficiency</b>					
(COWI, TI, DGC, 2013)	55-65	55-65	55-65	55-65	55-65
(ASUE, 2011)	22-65				
(International Energy Agency, 2010)	40-65		35-55		

Source: the values are based on COWI, TI, DGC (2013), ASUE (2011) and International Energy Agency (2010)

Table 19: Expected efficiency development of internal combustion engines (CHP-IC) presented in International Energy Agency (2010) and COWI, TI, DGC (2013) in %.

	Power range [kW <sub>el</sub> ]	2020	2030	2050	Source
Electrical efficiency	1-10	22	25		(COWI, TI, DGC, 2013)
	10-180	30-38	32-40		
	1-100			26-40	(International Energy Agency, 2010)
100-3000			35-45		
Thermal efficiency	1-10	70	70-75		(COWI, TI, DGC, 2013)
	10-180	55-62	55-64		
Total efficiency	1-10	92	95-100		(COWI, TI, DGC, 2013)
	10-180	92-94	95-96		
	1-100			80-90	(International Energy Agency, 2010)
100-3000			80-88		

### Stirling engine

Stirling engines currently have a thermal efficiency of 55 – 80% and an electrical efficiency of 12 – 25% (c.f. COWI, TI, DGC, 2013). It is expected that the total efficiency can be increased to 91 – 106% by 2030 COWI, TI, DGC (2013).

The cost data shown in Table 20 is based on COWI, TI, DGC (2013) and extrapolated for the other Member States as described in chapter 2.2. As Stirling engines are still in

the market introduction phase major cost decreases of approximately 40% are expected by 2020 reaching almost 60% by 2030. In the reports examined there is no information about annual operation and maintenance costs as a percentage of the investment costs. In COWI, TI, DGC (2013) it is only mentioned that variable O&M costs are between 0.6 and 0.8 €/GJ.

The technical lifetime of Stirling engines is about 15 years for small engines with 1 kW<sub>el</sub> and 10 years for larger units with 7 kW<sub>el</sub> (COWI, TI, DGC, 2013). The technical lifetime is expected to increase by 2030, but no explicit values are given in COWI, TI, DGC (2013) or the other reports analysed.

Table 20: Specific investment costs in €/kW<sub>el</sub> of Stirling engine CHPs with an electrical power of below 25 kW<sub>el</sub> in buildings in the EU27.

	2012	2020	2030
Austria	9,806	5,720	4,086
Belgium	7,980	4,655	3,325
Bulgaria	3,651	2,130	1,521
Croatia	n.a.	n.a.	n.a.
Cyprus	6,019	3,511	2,508
Czech Republic	5,320	3,104	2,217
Denmark	12,000	7,000	5,000
Estonia	5,747	3,352	2,395
Finland	8,797	5,132	3,665
France	9,612	5,607	4,005
Germany	9,708	5,663	4,045
Greece	5,864	3,421	2,443
Hungary	5,000	2,917	2,083
Ireland	8,301	4,842	3,459
Italy	6,388	3,726	2,662
Latvia	6,709	3,913	2,795
Lithuania	5,972	3,483	2,488
Luxembourg	8,271	4,825	3,446
Malta	5,203	3,035	2,168
Netherlands	10,398	6,066	4,333
Poland	5,757	3,358	2,399
Portugal	4,787	2,792	1,994
Romania	3,699	2,158	1,541
Slovakia	5,622	3,279	2,342
Slovenia	6,136	3,579	2,557
Spain	6,621	3,862	2,759
Sweden	11,699	6,824	4,875
United Kingdom	9,398	5,482	3,916

Source: based on the values for Denmark given in COWI, TI, DGC (2013) and extrapolated to the other Member States following the methodology of Connolly et al. (2013) for the EU27. Country factors for Croatia, Iceland, Norway and Switzerland could not be derived from this source. The cost reduction is based on the values given in COWI, TI, DGC (2013)

### **Fuel cell**

According to COWI, TI, DGC (2013) fuel cells currently have a thermal efficiency of 50 – 60% and an electrical efficiency of 35 – 40%. In the coming years overall efficiencies of 95 – 102% are expected. According to Ammermann et al. (2015) manufacturers recently reached electrical efficiencies of more than 60% and of up to 58% thermal efficiency.

The cost data shown in Table 21 is based on COWI, TI, DGC (2013) and extrapolated for the other Member States as described in chapter 2.2. Cost reductions of approximately 50% are expected by 2020 and 70% by 2030 (COWI, TI, DGC, 2013). It is assumed that the same cost reduction is achievable in all Member States.

Annual maintenance costs currently account for approximately 1.3% of the investment costs for small systems with the potential of reducing this by up to approximately 60%, leading to future fixed maintenance costs of 0.5% (Ammermann et al., 2015). This excludes the cost of stack replacement, which is necessary during the lifetime of a stationary fuel cell, and which currently amounts to approximately 6,700 Euro per stack (1 kW<sub>el</sub>). Costs for stack replacement are expected to drop to 1,200 Euro per stack under mass-market production (see Ammermann et al. 2015).

Currently, the technical lifetime of stationary fuel cells is about 7 years (COWI, TI, DGC, 2013). It is expected that the lifetime can be increased to more than 10 years (COWI, TI, DGC, 2013). In Ammermann et al. (2015) it is stated that some manufacturers expect lifetimes of 17 to 20 years with only one stack replacement.

Table 21: Specific investment costs in €/kW<sub>el</sub> of fuel cell CHPs with an electrical power of 1.5 – 20 kW<sub>el</sub> in buildings in the EU27.

	2012	2020	2030
Austria	13,622	3,767	2,226
Belgium	11,085	3,065	1,811
Bulgaria	5,071	1,402	829
Croatia	n.a.	n.a.	n.a.
Cyprus	8,361	2,312	1,366
Czech Republic	7,391	2,044	1,208
Denmark	16,670	4,610	2,724
Estonia	7,983	2,208	1,304
Finland	12,220	3,379	1,997
France	13,353	3,692	2,182
Germany	13,487	3,729	2,204
Greece	8,146	2,253	1,331
Hungary	6,946	1,921	1,135
Ireland	11,531	3,188	1,884
Italy	8,874	2,454	1,450
Latvia	9,320	2,577	1,523
Lithuania	8,295	2,294	1,355
Luxembourg	11,490	3,177	1,877
Malta	7,228	1,999	1,181
Netherlands	14,445	3,994	2,360
Poland	7,997	2,211	1,307
Portugal	6,649	1,839	1,086
Romania	5,139	1,421	840
Slovakia	7,809	2,159	1,276
Slovenia	8,524	2,357	1,393
Spain	9,198	2,543	1,503
Sweden	16,252	4,494	2,655
United Kingdom	13,055	3,610	2,133

Source: based on the values for Denmark given in COWI, TI, DGC (2013) and extrapolated to the other Member States following the methodology of Connolly et al. (2013) for the EU27. Country factors for Croatia, Iceland, Norway and Switzerland could not be derived from this source. The cost reduction is based on the values given in COWI, TI, DGC (2013)

### 2.3.3 Technology stock distribution

The use of decentralised CHP units is not widespread in the Member States of the European Union. Furthermore, there is poor data availability. Therefore, the data presented in the following only refers to internal combustion engines (ICs) installed in buildings and does not give an overall picture of the currently installed stock in Europe. The most detailed data available was that for Germany.

The available stock data are listed in Table 22. From the countries with available data, the units installed in Germany account for 89% of all units installed. Most CHP-ICs

have an installed electrical power of below 25 kW<sub>el</sub> (78% of installed units; in Germany 83% of installed units).

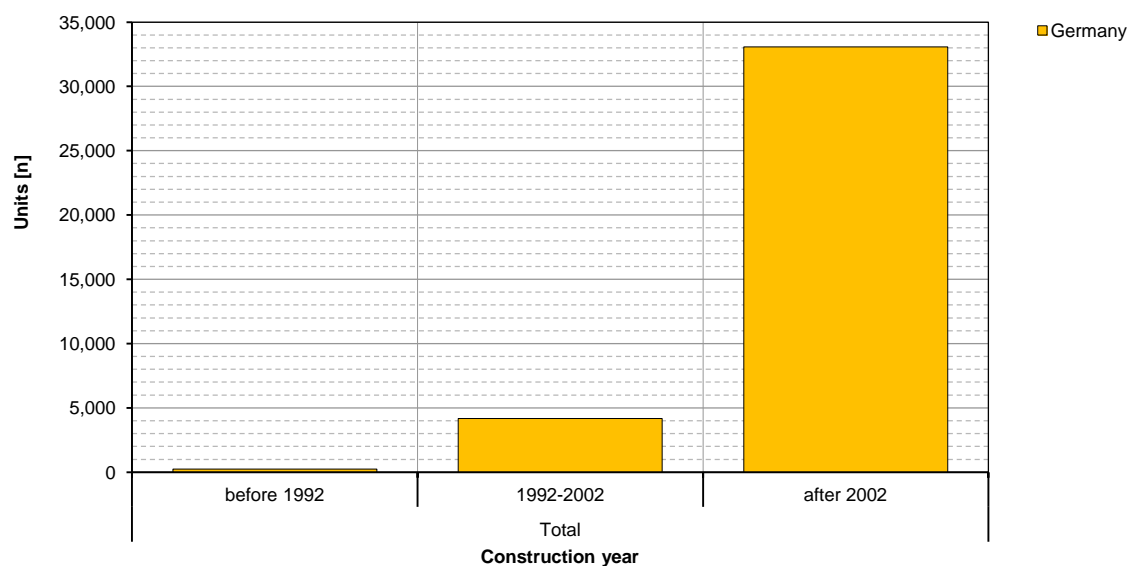
The more detailed information given in the following only refers to Germany as the information was not available in the other countries listed in Table 22. Concerning the installed capacity, the smallest capacity category only plays a minor role (13% of installed capacity). The largest share in terms of electrical capacity is provided by the units with more than 250 kW<sub>el</sub> installed capacity (63%). The age distribution presented in Figure 14 underlines the above mentioned fact that decentralised CHP-units in buildings are relatively new compared to the other fossil fuel fired heating technologies. 88% of the units were installed after 2002 and less than 1% before 1992. For the capacity, the picture slightly differs: 10% of the capacity was installed before 1992 and only 55% after 2002 (see Figure 15).



Table 22: Stock of CHP – internal combustion engines in selected countries.

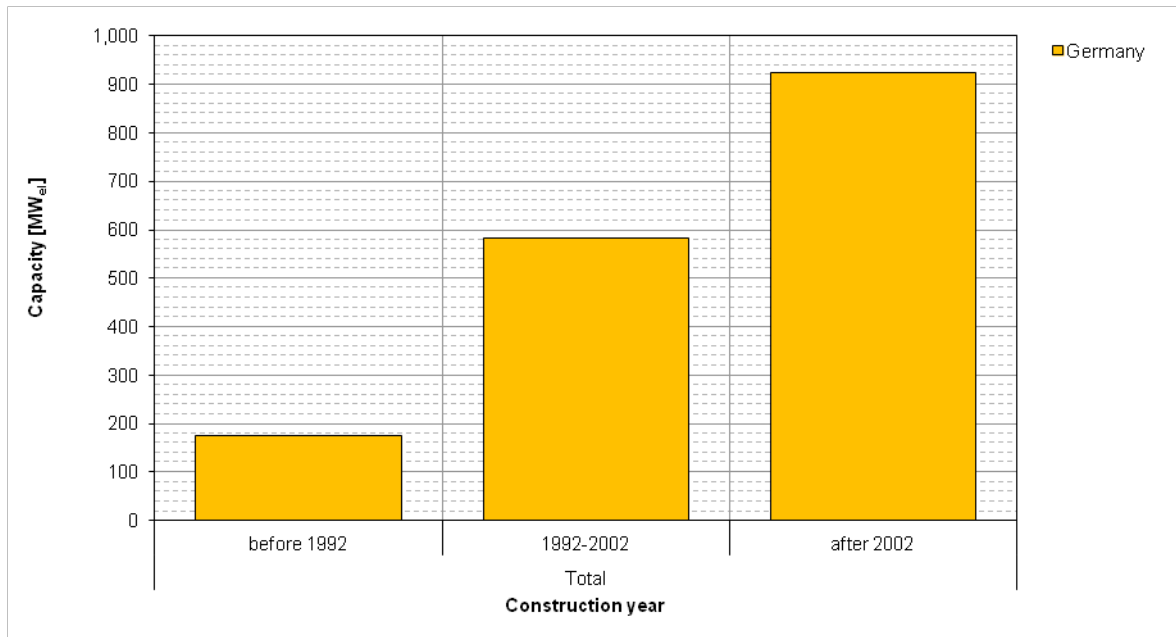
	<25 kW	25 – 100 kW	101 – 250 kW	>250 kW	Total
Belgium	110 <sup>s</sup>	0 <sup>s</sup>	95 <sup>s</sup>	0 <sup>s</sup>	205 <sup>s</sup>
France	n.a.	n.a.	n.a.	n.a.	800 <sup>s</sup>
Germany	31,044 <sup>s</sup>	3,395 <sup>s</sup>	1,937 <sup>s</sup>	1,126 <sup>s</sup>	37,502 <sup>s</sup>
Latvia	19 <sup>s</sup>	n.a.	91 <sup>s</sup>	n.a.	110 <sup>s</sup>
Netherlands	1,000 <sup>s</sup>	n.a.	0 <sup>s</sup>	n.a.	1,000 <sup>s</sup>
Portugal	3 <sup>s</sup>	n.a.	11 <sup>s</sup>	n.a.	14 <sup>s</sup>
Slovenia	142 <sup>s</sup>	n.a.	64 <sup>s</sup>	n.a.	206 <sup>s</sup>
Spain	10 <sup>s</sup>	n.a.	190 <sup>s</sup>	n.a.	200 <sup>s</sup>
United Kingdom	569 <sup>s</sup>	575 <sup>s</sup>	0 <sup>s</sup>	1,158 <sup>s</sup>	2,302 <sup>s</sup>
Methodology: x = interpolation/ extrapolation a = ad hoc calculation s = direct use of the source m = modelling	Sources: (COGEN Europe, 2013; Bundesamt für Wirtschaft und Ausfuhrkontrolle BAFA, 2014, Department of Energy & Climate Change, 2015a, 2015b, Swedish Energy Agency (Westin, Paul), 2015; Giesler, Silke (statista GmbH), 2015; Duviolguerbigny, Arnaud (Cogen Europe), 2015)				

Figure 14: Age of combined heat and power internal combustion engines in buildings in Germany relating to the installed quantity.



Source: own illustration based on (Bundesamt für Wirtschaft und Ausfuhrkontrolle BAFA, 2014)

Figure 15: Age of combined heat and power internal combustion engines in buildings in Germany relating to the installed capacity.



Source: own illustration based on (Bundesamt für Wirtschaft und Ausfuhrkontrolle BAFA, 2014)

Remaining data gaps:

Statistics on the installed number of units and capacities in different capacity and age categories are not publicly available in almost all examined countries.

## 2.4 Heat pumps

### 2.4.1 Scope and description of technology

A heat pump is a device used to transfer heat energy from one source of heat (air, ground or water) to another destination for several end energy uses (space heating, water heating, cooling). Mechanical heat pumps exploit the physical properties of a volatile evaporating and condensing fluid known as a refrigerant. The heat pump compresses the refrigerant to make it hotter on the side to be warmed, and releases the pressure on the side where heat is absorbed.

Some devices are reversible. This kind of heat pump works in either thermal direction to provide heating or cooling to the internal space. It employs a reversing valve to reverse the flow of refrigerant from the compressor through the condenser and evaporation coils.

Heat pump technologies can be aérothermal devices, which take energy from the ambient air (indoor or outdoor), geothermal (energy extracted from the ground) or hydrothermal (energy extracted from water - lake or subterranean water sources). Generally, hydro- and geothermal heat pumps are grouped together as geothermal technologies.

In WP2, the following heat pump technologies were analysed:

Table 23: Description of ambient heat technologies surveyed.

Geothermal technology	Geothermal H.P	Direct expansion H.P
		Brine/Water
	Hydrothermal H.P	Water/Water
Aerothermal technology	Aerothermal H.P	Air/Water
	Aerothermal H.P	Air/Air

Source: Observ'ER 2015

The project initially planned to cover hybrid heat pumps as well as gas absorption heat pumps. However, because these technologies are quite new, there are currently no statistics on the market about their total installed capacity.

According to the European Heat Pump Association (EHPA), in Europe, the total number of heat pumps (for all technologies) is estimated at around 25 million units. In 2012 and 2013, the annual sales figures show a market of over 1.6 million units. Heat pumps are one of the most widespread renewable technologies in Europe, especially in individual households. This sector is currently more important than solar thermal applications.

The market is not distributed equally across all the heat pump technologies: aérothermal heat pumps account for approximately 90% of the annual European market sales compared to 10% for geothermal devices.

The following data sources are available for monitoring units of installed heat pumps and their energy capacity:

- Data provided on the Shares website (but not all the EU28 are available)
- Data from the EHPA association (but not all the EU28 are available)

- A desk research data collection conducted by Observ'ER, mainly geared towards national associations promoting heat pumps

On a data level, the heat pump sector is difficult to survey for several reasons. The total installed capacity in most European countries is poorly surveyed. The technologies of heat pumps have developed in several cycles over the last 30 years and only figures for the last 10 years are available.

For the heat pump sector, the two main data sources used were the data series from EHPA association and the data collected from public agencies in charge of the official national figures. The data chosen by Observ'ER for the WP2 were mainly figures provided by official agencies. For countries which no official data has been collected, the EHPA source has been used. For several countries, differences exist between official figures and EHPA data. Most of the time, these differences come from the fact that the calculation of the total installed capacity at the end of 2012 is not only made from the same series of annual sales data.

For two countries (France and Italy) the data difference between Ministries and EHPA is much more important. This comes from a methodological choice. These countries consider that any air / air heat pumps installed in their territory meet the energy efficiency requirements of the European directive and can be counted as renewable appliances for heat and cooling. However, the EHPA Association considers that only a small proportion (10%) of these devices can actually be regarded as heat pumps and the rest are mainly used for air conditioning needs (chillers). For this two countries, Observ'ER used the official figures from Ministry.

Data from desk research were selected if they provided more detail than the other two sources (and EHPA Shares). Concerning the Shares figures, it was observed that more and more countries are consolidating their heat pump sector data. EU28 Member States are trying to improve the monitoring of the heat pump sector to increase the renewable energy production of this sector in their energy balances.

The following tables present for each country the figures of aerial and geothermal heat pumps installed (in quantity) and the sources used. For comparison, figures from EHPA are also presented.

Table 24: Technical specification of aerial heat pumps installed in European Union in 2012

Aerothermal heat pumps in number of units	Figure used for WP2	Data sources	EHPA figures
Austria	142 657	EHPA	142 657
Belgium	18 826	EHPA	18 826
Bulgaria	149 962	Bulgarian association of ecological energy	no data
Croatia	0	EHPA	no data
Cyprus	0	EHPA	no data
Czech Republic	23 416	Ministry of Industry and trade	18 341
Denmark	308 119	Danish Energy Agency	104 857
Estonia	59 097	Ministry of Industry	59 097
Finland	416 223	SULPU (Finish Heat pumps association)	423 337
France	4 960 150	SOeS	908 009
Germany	223 000	AGEE-Stat	327 450
Greece	0	EHPA	no data
Hungary	1 682	EHPA	1 682
Ireland	2 672	EHPA	2 672
Italy	15 972 000	Ministry of economic development	1 011 373
Latvia	0	EHPA	no data
Lithuania	690	EHPA	690
Luxembourg	742	Ministry of economic development	no data
Malta	0	NSO Statistic malta	no data
Netherlands	147 815	CBS Statistics Netherlands	22 978
Poland	5 445	IEO	16 977
Portugal	74 558	EHPA	74 558
Romania	0	EHPA	no data
Slovakia	4 590	EBC Energy Center Bratislava	1 625
Slovenia	7 473	Ministry of industry	no data
Spain	194 508	EHPA	194 508
Sweden	821 266	EHPA	821 266
U.K	65 835	EHPA	65835
Norway	556 392	EHPA	556392
Switzerland	87 323	EHPA	87323
Iceland	0	EHPA	no data
Total	24 244 441		4 860 453

Source: Observ'ER 2015

Table 25: Technical specification of geothermal heat pumps installed in European union in 2012

Aerothermal heat pumps in number of units	Figure used for WP2	Data sources	EHPA figures
Austria	83 088	EHPA	83 088
Belgium	4 672	EHPA	4 672
Bulgaria	3 749	Bulgarian association of ecological energy	no data
Croatia	0	EHPA	no data
Cyprus	0	EHPA	no data
Czech Republic	23 416	Ministry of Industry and trade	13 494
Denmark	36 335	Danish Energy Agency	20 891
Estonia	5 955	EHPA	5 955
Finland	56 000	SULPU (Finish H.P Association)	61 481
France	123 045	SOeS	101 100
Germany	272 200	AGEE-Stat	264 690
Greece	0	EHPA	no data
Hungary	1 577	EHPA	1 577
Ireland	2 388	EHPA	2 388
Italy	10 500	Ministry of economic development	7 428
Latvia	0	EHPA	no data
Lithuania	1 623	EHPA	1 623
Luxembourg	106	STATEC	no data
Malta	0	NSO Statistic malta	no data
Netherlands	30 400	EHPA	30 400
Poland	4 706	IEO	14 476
Portugal	2 996	EHPA	2 996
Romania	0	Observ'ER data collection	no data
Slovakia	1 021	EHPA	1 021
Slovenia	4 669	ECB Energy Center Bratislava	no data
Spain	898	EHPA	898
Sweden	428 589	EHPA	428 589
U.K	18 584	EHPA	18 584
Norway	22803	EHPA	22803
Switzerland	61 685	EHPA	61 685
Iceland	0	EHPA	no data
Total	1 201 005		1 149 839

Source: Observ'ER 2015

### 2.4.2 Technology characterisation

All the details of the data collected for each EU28 Member State is available in the templates accompanying this report. The following tables summarise European average data for the two heat pump technologies surveyed:

Table 26: Technical specification of heat pump application.

	Technical lifetime	Thermal efficiency – seasonal performance factor (SPF)	Specific investment cost	Sold units 2012	Sold units 2013
Aerothermal HP	20	2,5 – 2,7	1 130 € / kW	1 525 964	1 502 094
Geothermal HP	20	3,2 – 3,5	1 675 € / kW	96 748	89 526

Source: Observ'ER 2015

These technical specifications are valid for individual heat pumps whose capacity does not exceed 30 kW.

EHPA publications were used as the data source for the average costs. Their data are collected across all European countries by their network of expert contacts. This source has a common methodology framework.

The market data were taken from EHPA publications if available. For other countries, data come from the EurObserv'ER collection, which used the following sources: Bulgarian Association of ecological energy producers (Bulgaria), Ministry of Industry and Trade (Czech Republic), Danish Energy Agency (Denmark), Finnish Heat Pumps Association (Finland), NSO Statistic Malta (Malta), CBS Statistics Netherlands, EBC Energy Center Bratislava (Slovakia) and Ministry of Industry (Slovenia).

### 2.4.3 Technology stock distribution

Table 27: Age distribution of aerothermal heat pumps (in number of units).

Aerothermal heat pumps in number of units	> 20 years		10-20 years		< 10 years	
	<20 kW	> 20 kW	<20 kW	> 20 kW	<20 kW	> 20 kW
Austria	17 247	1 298	50 415	3 795	65 009	4 893
Belgium	0	0	0	0	16 943	1 883
Bulgaria	0	0	0	0	134 966	14 996
Croatia	0	0	0	0	0	0
Cyprus	0	0	0	0	0	0
Czech Republic	0	0	0	0	21 074	2 342
Denmark	0	0	0	0	301 957	6 162
Estonia	0	0	0	0	57 915	1 182
Finland	0	0	0	0	395 412	20 811
France	0	0	0	0	4 910 549	49 602
Germany	207	16	23 642	1 780	183 540	13 815
Greece	0	0	0	0	0	0
Hungary	0	0	0	0	1 396	286
Ireland	0	0	0	0	2 218	454
Italy	0	0	0	0	11 659 560	4 312 440
Latvia	0	0	0	0	0	0
Lithuania	0	0	0	0	621	69
Luxembourg	0	0	0	0	668	74
Malta	0	0	0	0	0	0
Netherlands	0	0	0	0	121 208	26 607
Poland	0	0	0	0	4 792	653
Portugal	0	0	0	0	65 611	8 947
Romania	0	0	0	0	0	0
Slovakia	0	0	0	0	3 672	918
Slovenia	0	0	0	0	6 726	747
Spain	0	0	0	0	190 618	3 890
Sweden	0	0	55 846	9 855	642 230	113 335

Source: Observ'ER 2015



Table 28: Age distribution of geothermal heat pumps (in number of units).

Geothermal heat pumps in number of units	> 20 years		10-20 years		< 10 years	
	<20 kW	> 20 kW	<20 kW	> 20 kW	<20 kW	> 20 kW
Austria	1 496	166	14 956	1 662	58 328	6 481
Belgium	0	0	0	0	4 205	467
Bulgaria	0	0	0	0	3 374	375
Croatia	0	0	0	0	0	0
Cyprus	0	0	0	0	0	0
Czech Republic	0	0	0	0	21 074	2 342
Denmark	356	7	4 273	87	30 979	632
Estonia	0	0	0	0	5 836	119
Finland	0	0	0	0	53 200	2 800
France	0	0	0	0	121 815	1 230
Germany	0	0	0	0	253 146	19 054
Greece	0	0	0	0	0	0
Hungary	0	0	0	0	1 309	268
Ireland	0	0	0	0	1 982	406
Italy	0	0	0	0	7 665	2 835
Latvia	0	0	0	0	0	0
Lithuania	0	0	0	0	1 461	162
Luxembourg	0	0	0	0	95	11
Malta	0	0	0	0	0	0
Netherlands	0	0	0	0	24 928	5 472
Poland	0	0	0	0	4 235	471
Portugal	0	0	0	0	2 696	300
Romania	0	0	0	0	0	0
Slovakia	0	0	0	0	817	204
Slovenia	0	0	0	0	4 202	467
Spain	0	0	0	0	880	18
Sweden	0	0	72 860	12 858	291 441	51 431

Source: Observ'ER 2015

The three main European countries using heat pump technology are Italy, France and Sweden. Italy and France have strongly pushed the development of their national household heat pump market by offering tax credits or tax reductions. These policies that were launched in the mid 2000s have made these two countries the first European market for heat pumps.

In Italy, a significant share of heat pumps and sales of installed equipment is due to air / air reversible heat pumps, whose main function is air conditioning. Monitoring the energy production of the equipment is controversial, because some sources (such as EHPA) consider their COP not high enough to be considered a renewable energy, while official country data integrate them into the national statistics.

## 2.5 Biomass boilers

### 2.5.1 Scope and description of technology

The two main biomass applications surveyed in the study are individual biomass stoves and biomass furnaces.

A biomass furnace is a closed vessel in which water or some other fluid is heated. The heated or vaporised fluid exits the boiler for use in various processes or heating applications. In households, the two main applications are: hot water and central heating.

Picture of an individual pellet biomass furnace with storage tank.



Source: Credit : ÖkoFen ©

A biomass stove is an enclosed box in which fuel is burned to provide heating, either to heat the space where the stove is situated, or to heat the stove itself and the items placed on it. The main difference to a boiler is the fact that there is no heated fluid in the system.

Picture of an individual pellet biomass stove.



Source: Credit : Supra ©

Regarding the technologies covered for each application :

- Individual biomass stoves include all individual wood heating appliances (closed fireplaces and stoves) operating with wood pellets, wood logs or wood chips and whose main function is household space heating. The power ranges included are up to 50 kW.
- Biomass furnaces include boilers operating with wood pellets, wood logs or wood chips, and whose main function is household space heating and domestic hot water.

In terms of final energy consumption, biomass is the leading renewable energy carrier in Europe. In the residential sector, biomass applications are also the most widely disseminated and used renewable applications. According to the Eurostat database, the final energy consumption from solid biomass (excluding biogas and renewable municipal solid waste) was around 76.8 Mtoe in 2012 and 2013.

However, biomass capacity, particularly in the residential sector, is poorly monitored in the available statistics. In national statistics, the final energy consumption of biomass end devices is usually evaluated based on household equipment surveys multiplied by the wood consumption ratio for the different user profiles.

There are no figures available on the current total capacity installed. The only statistics available are those on pellet appliances. Most of the EU28 countries conduct sales surveys and have statistical data on the installed capacities for this technology, which has developed mainly over the last 10 years in Europe. However, these devices represent only a minority of all the wood-based appliances.

The only data sources on solid biomass furnaces and stoves are from the European Pellet Council (EPC) and AEBIOM. These only concern the pellet appliances market.

In order to collect the maximum amount of available data, Observ'ER conducted desk

research for all EU28 Member States. This mainly targeted the websites of national energy agencies, associations promoting biomass and scientific research centres specialised in wood energy applications. The sources identified in the desk research are listed below and entered in the references listed in this report:

Ademe (France), AEBIOM (European Biomass Association), Associazione Italiana Energie Agroforestali (AIEL - Italy), Bundesministerium für Verkehr, Innovation und Technologie (BMViT – Austria), CEREN (France), Deutsches Biomasse Forschungs Zentrum (DBFZ – Germany), Finnish pellet energy association, Hungarian Pellet Association, Propellet European network associations, Svebio (Swedish Bioenergy Association), ValBiom (Belgium), Bundesamt für Statistik (Switzerland).

No information was collected for the following countries : Bulgaria, Croatia, Cyprus, Czech Republic, Denmark, Greece, Lithuania, Luxembourg, Malta, Romania, Slovenia, Norway and Iceland.

### 2.5.2 Technology characterisation

All the data collected for each EU28 Member State is available in the templates accompanying this report. The following table summarises European average data for the two solid biomass appliances surveyed.

Table 29: Technical specifications of biomass appliances.

	Technical lifetime	Thermal efficiency	Specific investment cost in €	Sold units 2012	Sold units 2013
Biomass furnace	25	90 %	n.a	4 363	5 152
Indiv. biomass stoves	25	90 %	974 €	854 253	827 339

Source: [Observ'ER 2015](#)

cifications are valid for individual biomass appliances (furnaces and stoves) whose capacity does not exceed 50 kW.

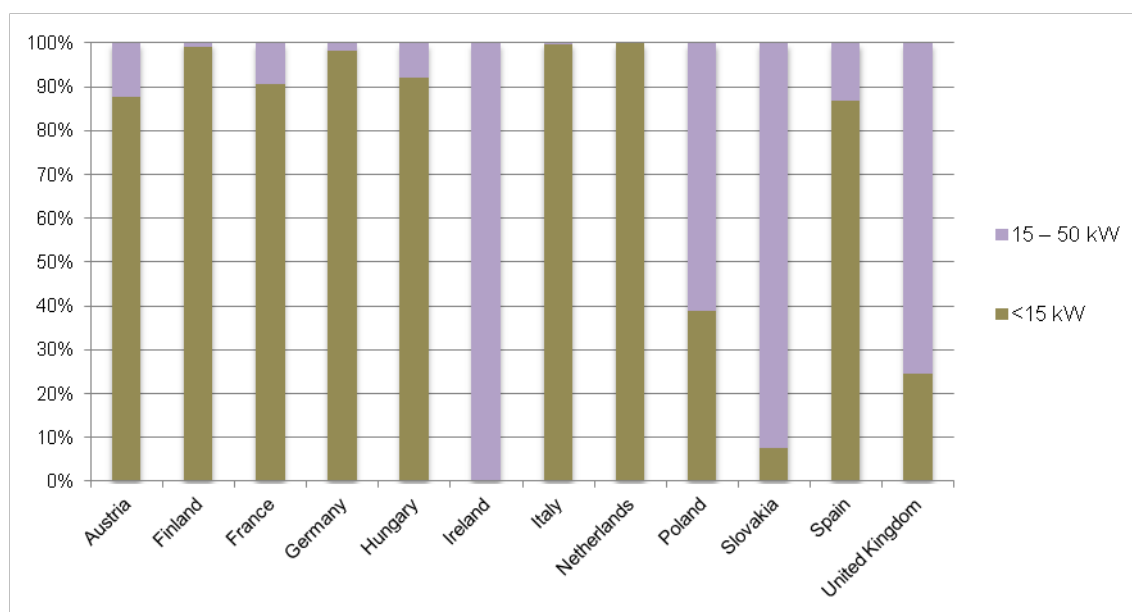
Data about the specific costs of individual biomass stoves were not collected. and were extrapolated from the 2nd Pre-Study for the Heat Roadmap Europe, which cites average costs for several RES technologies (including biomass stoves) for Germany.

Market data were only available for fewer than ten European countries. Moreover, these figures essentially concern the sales of pellet appliances. The large data gap for this sector is due to the fact that market data on wood logs and wood chips are missing for many of the EU28 Member States.

### 2.5.3 Technology stock distribution

The limited available information on installed capacity only allowed a disaggregation based on power thresholds and only for individual stoves. The best available data in this sector concerned systems with a capacity below 15 kilowatts or between 15 and 50 kilowatts.

Figure 16: 2012 Power distribution of individual solid biomass stoves (in %).



Source: Observ'ER 2015

The above diagram illustrates the power distribution of the biomass stoves in the 12 countries for which such data were collected. 100% is the total number of biomass stoves and the blue and red bars show the share of stoves in each capacity rating.

It is difficult to comment on these figures and compare countries with each other because it is very likely that the data for some countries are not complete. The most reliable data are for the main countries using wood energy (Austria, Germany, Finland, France, and Italy). It can be seen that stoves with an output below 15 kW make up the major share of installed capacity. These stoves are those used by individuals (including individual homes) and have the highest sales figures.

## 2.6 Solar thermal

### 2.6.1 Scope and description of technology

Solar thermal energy is a form of energy and a technology for harnessing solar energy to generate thermal energy for use in industry, the residential, and commercial sectors. The thermal energy obtained from solar radiation is used in order to heat a fluid (liquid or gas). The energy stored in the fluid can then be used directly (hot water, heating, etc.) or indirectly (to produce steam to drive generators and thus obtain electrical energy, produce cold, etc.). Solar collectors are used to convert sunlight into heat. Here, we refer to low-temperature solar thermal technologies which are only used for sanitary hot water and space heating (and occasionally for cooling).

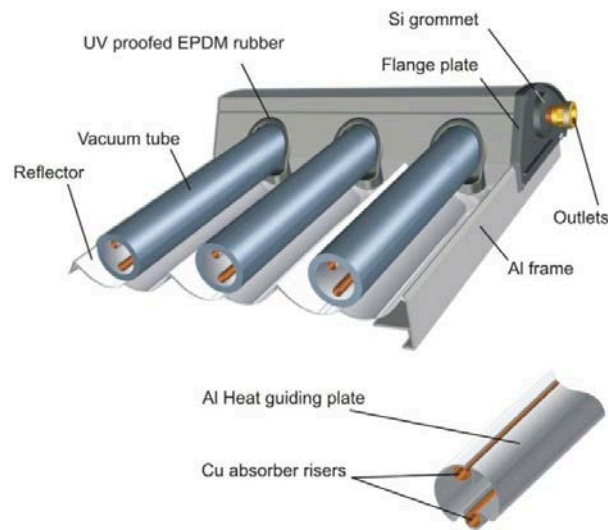
The data collected in the WP2 on the solar thermal sector concern two collector technologies:

- Glazed flat plate collectors are by far the most prevalent technology in Europe. They consist of a dark flat plate absorber, a transparent cover that reduces heat losses, a heat-transporting fluid (air, antifreeze or water) to remove heat from the absorber, and an insulated backing. The absorber consists of a thin absorber sheet often backed by a grid or coil of fluid tubing in an insulated casing with a glass or polycarbonate cover. In water heating panels, fluid is usually circulated through the tubing to transfer heat from the absorber to an insulated water tank



Source: Credit : GreenOneTec ©

- Vacuum solar collectors are composed of multiple evacuated glass tubes each containing an absorber plate fused to a heat pipe. The heat is transferred to the transfer fluid (water or an antifreeze mix) of a domestic hot water or hydronic space heating system in a heat exchanger called a "manifold". The manifold is wrapped in insulation and covered by protective sheet metal or a plastic case. The vacuum that surrounds the outside of the tube greatly reduces convection and conduction heat losses, achieving greater efficiency than flat-plate collectors, especially in colder conditions.



Source: Credit : GreenOneTec ©

According to the Eurostat database, the final energy consumption from solar thermal energy was 1.8 Mtoe in 2012 and 1.9 Mtoe in 2013.

Although the Eurostat website has a database covering the solar thermal sector, this does not include any details about the application sector (residential, industry, etc.) or the type of solar collector.

The European Solar Thermal Industry Federation (ESTIF) database is another available source, which provides figures about annual markets and installed capacity for all EU28 countries. But similar to the Eurostat database, there are no details available about application sectors and types of collectors.

The only other available source is the data collection made in the EurObserv'ER barometers (project managed by Observ'ER). For nearly 15 years, EurObserv'ER project has collected data every year of the annual sales of collectors in all European countries. The advantage of this source is that it contains information on the type of collectors and distribution of the installed capacity across the residential, industry, and tertiary sectors.

For Switzerland, Norway and Iceland no figures about have been collected through the EurObserv'ER project or the ESTIF database.

We compared data from the EurObserv'ER and Eurostat databases for the solar thermal sector in 2012. For that year, the total solar thermal capacity in all EU28 countries is estimated by EurObserv'ER at 41 360 000 m<sup>2</sup> compared to 46 262 000 m<sup>2</sup> by Eurostat. The main differences between the two sources are for 2 countries: Denmark and UK.

Eurostat cites 2 600 000 m<sup>2</sup> for Denmark and 4 448 000 m<sup>2</sup> for the UK at the end of 2012. These figures do not comply with the data collected by Observ'ER (753 000 and 650 000 m<sup>2</sup> respectively) and the data published by ESTIF (683 000 for Denmark and 709 000 m<sup>2</sup> for UK). One explanation could be that the Eurostat data for Denmark and the UK express the installed capacity for all solar panels (PV + solar thermal) rather than just the thermal part.

To complete the WP2 template, Observ'ER used data from the EurObserv'ER barometer database. This methodology allowed the total installed capacity to be divided between the different equipment ages.

The data on average costs are from the EurObserv'ER data collection questionnaires. These data were obtained for 7 European countries (Austria, France, Hungary, Malta, Slovenia, Spain and Denmark). The costs for other European countries were estimated by comparing them to the countries for which information was available (e.g. size of the market and climate). Average cost data were only collected for flat plate collectors.

### 2.6.2 Technology characterisation

The detailed data compiled for each EU28 Member State is available in the templates accompanying this report. The following table summarises European average data for the two solar thermal technologies surveyed.

Table 30: Technical specifications for solar thermal appliances.

	Technical lifetime	Thermal efficiency	Specific investment cost in €	Sold units 2012	Sold units 2013
Flat plate collectors	25	60 %	773 €	2 888 960	2 628 100
Vacuum collectors	25	60 %	n.a	396 732	318 191

Source: Observ'ER 2015

These data are for solar thermal applications in the residential sector.

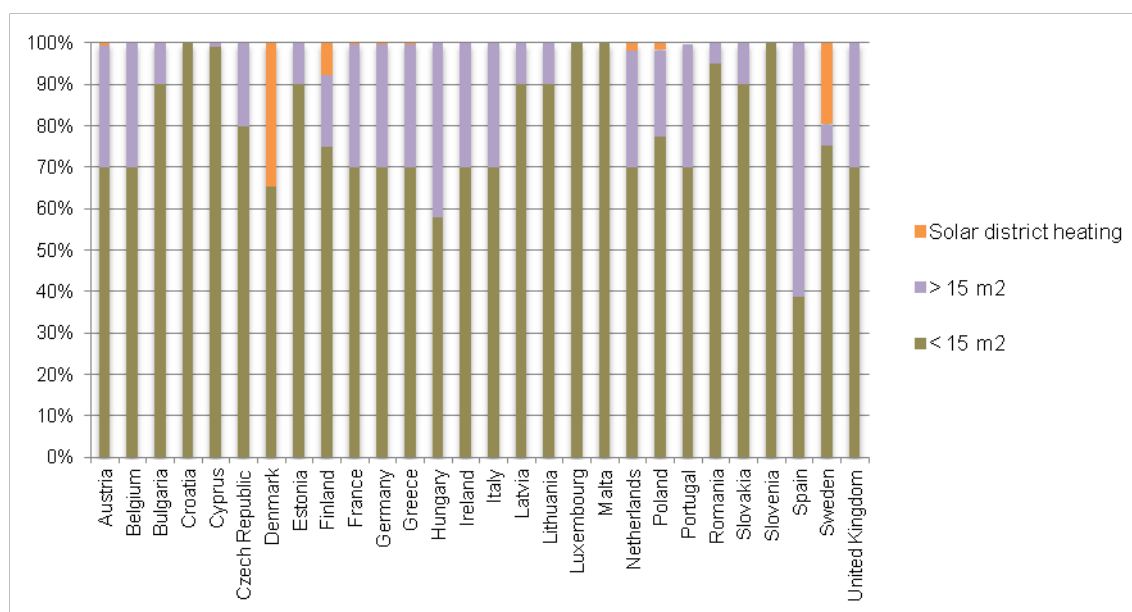
### 2.6.3 Technology stock distribution

The following figures illustrate the composition of the European solar thermal installed capacity according to various indicators.

Flat plate collectors are the most common type of solar thermal appliance in Europe (with about 90% of the total market). Figure 17 shows the breakdown of flat plate collectors for three types of applications: individual applications (<15 m<sup>2</sup>), Multi-family application (>15m<sup>2</sup>), and district heating (a solution mainly developed in Denmark).



Figure 17: Size distribution of flat plate collectors in Europe in 2012

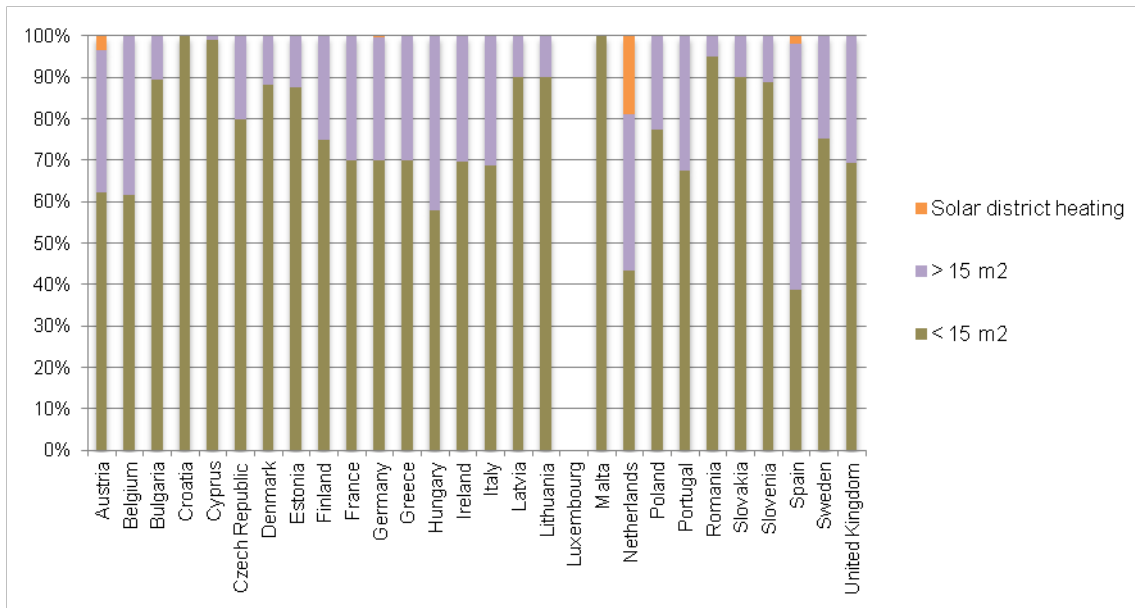


Source: Observ'ER 2015

Individual installations with less than 15 m<sup>2</sup> are the most common application in Europe. Only Spain has a larger share of Multi-family facilities. This can be explained by the fact that, during the 2000s, Spanish law made solar thermal energy mandatory in all the country's new Multi-family constructions. This has greatly expanded this market segment.

In terms of district heating based on solar thermal, these solutions have mainly been developed in northern Europe. Denmark is the leading country in this field followed by Sweden.

Figure 18: Size distribution of vacuum collectors in Europe in 2012

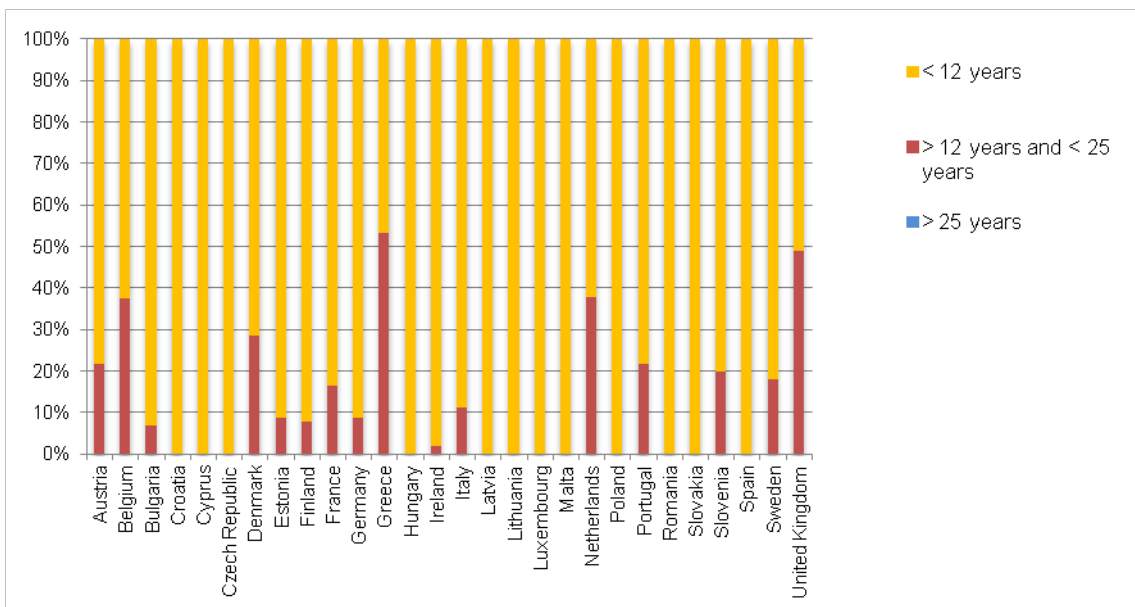


Source: Observ'ER 2015

Vacuum collectors are mostly found in the main countries using solar thermal technology in Europe such as Germany, France or Greece. Some countries such as Poland or Czech Republic have recently introduced support for their solar thermal sector, which has boosted vacuum technology development.

The following two figures show the age distribution of solar thermal collectors.

Figure 19: Age distribution of flat plate collectors in 2012



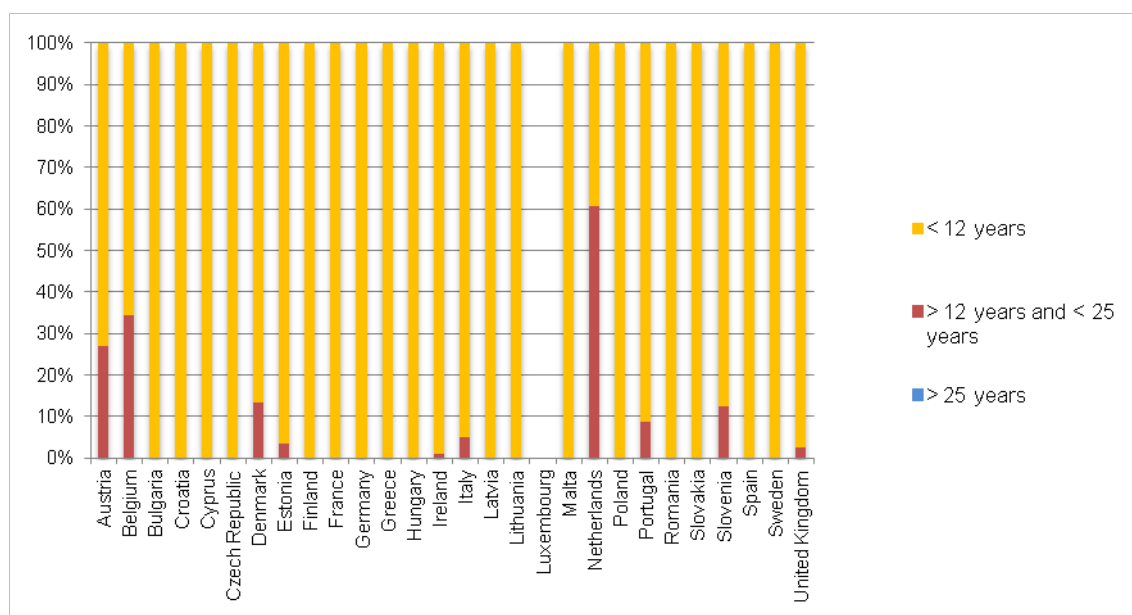
Source: Observ'ER 2015

The total installed capacity in Europe has been surveyed since the revival of the sector

from the mid 90s. The late 1970s marked the first important beginnings of the sector, but there are virtually no data for this period and many of these early facilities have since been decommissioned. This explains why there are no figures for the share of collectors older than 25 years.

The countries with the largest share of solar thermal in Europe are Germany and to a lesser extent France. Germany alone accounts for almost 40% of Europe's total solar area, which has basically developed over the last 15 years.

Figure 20: Age distribution of vacuum collectors in 2012



Source: Observ'ER 2015

The vacuum collector technology is relatively recent and has only been on the market for about twenty years. This type of collector is more common in countries with less insolation (so more in the northern part of Europe) like the Netherlands, Belgium, Denmark and Austria.

## 2.7 Room air conditioning

### 2.7.1 Scope and description of technology

There are principally two different ways to supply cooling energy: thermally (adsorption, absorption) or electricity driven (compression cooling). In both cases, the driving energy can either be supplied by fossil or renewable sources.

As the standard of living rises in Europe, the need of refrigeration in households as well as in office buildings is expected to increase. The ratio of cooled area in office buildings is significantly higher than in households because of their building structure (e.g. larger window area).

#### Compression cooling

For the electricity driven air conditioning and refrigeration the compression cycle is the technology to produce cold as useful energy service. The refrigerant fluid is compressed by an electrically powered compressor to raise pressure and temperature. Afterwards it is cooled down in a condenser where it turns back to a fluid by exchanging the heat with a coolant. Refrigerant passes through an expansion valve where it expands to lower pressure and temperature and is able to cool down the coolant, which is on a higher temperature level.

Every compression cooling system has four basic elements which are run through by the refrigerant continuously:

- The evaporator is a heat exchanger on the suction side of the compressor. Liquid refrigerant evaporates under low pressure and low temperature. The heat needed to evaporate the refrigerant is taken from the medium to be chilled.
- In the compressor the evaporated refrigerant is compressed mechanically. It leaves the compressor at a high level of pressure and temperature
- (60 – 120 °C) still in gaseous form.
- The condenser is a heat exchanger on the pressure side of the compressor. The high-pressure refrigerant gas gives its heat to a cooling medium (air, water) and condenses. Afterwards the liquid refrigerant usually is held in an accumulator until it is needed.
- The throttle separates the high-pressure side of system from the low-pressure side. Further it meters the flow of the refrigerant into the evaporator and thereby the cooling power.

Different types of compressors increase the pressure of the refrigerant and are available in the market as: reciprocating compressors, scroll compressors, screw and centrifugal compressors.

#### Reciprocating Compressors

The compression of the refrigerant in reciprocating compressors is driven by the use of motors and pistons as well as cylinders and valves. Reciprocating compressors can be divided into hermetic, semi-hermetic, and open types (Jarn, 2014).

For commercial, industrial refrigeration and air conditioning applications different types of semi-hermetic and open types are used today. In particular, semi-hermetic reciprocating compressors are high efficient especially in the range between 15 and 75 KW. These types are very competitive in industrial refrigeration equipments requiring on the other hand maintenance.

In Europe the demand for reciprocating compressors remains the same in 2014 as it was reported for the year before. This technology for cooling uses in Europe is very

advanced and well developed. The use of these compressors with inverter control systems are slightly growing in the EU market. The advantage of inverter control is to enable precision control of refrigeration capacity increasing efficiency.

### **Scroll Compressors**

Scroll compressors are also known as vertical scroll compressors and are frequently used in air conditioning applications while horizontal scroll compressors are commonly adopted in refrigerated transportation, storage showcases and medical applications. The demand in these sectors is expected to increase as different factors drive for this development (trend to refrigerated convenience food and aging population).

Increase in energy efficiency for this type of compressors is enhanced with inverter control technologies. This has enhanced their energy efficiency and energy performance. Due to this the scroll compressor has been adopted by VRF and PAC products.

Scroll compressors can be used in a broad range of applications in air conditioning systems (RACs, PACs) and VRF systems as well as in industrial and commercial chillers and heat pumps and refrigeration systems including freezers.

In Europe the demand for these compressors has been showing an increasing trend due to air conditioning applications. Furthermore, an increased demand is also observed for commercial and industrial refrigeration and lately for heat pumps applications. The use of both digital and inverter units have also been increasing (Jarn, 2014).

### **Screw Compressor**

The global demand for screw compressors increased to roughly 150.000 units in 2014 in three markets especially in China (67.000 units), Europe (35.000) and USA (31.000 units). Major producers of screw compressors worldwide are China, the United States, Germany, Italy, Japan, and Taiwan. Screw compressors are increasingly used for commercial and industrial refrigeration applications including refrigerated transport vehicles. Large industrial applications contain semi-hermetic and open-type screw compressors and have a high market share (Jarn, 2015).

Due to the dramatic reduction of compressor parts, screw compressors are easy to maintain, more competitive and high reliable. Most common capacities diverge from ca. 40 kW until 500 kW for larger applications. In addition, reduced noise and vibration is attained due to the moving main and secondary rotors. Furthermore, low space requirements and low weight are competitive advantages.

For space cooling in residential sector there are mainly three different technologies differentiated according to the Eco-Design Directive LOT 10 residential room conditioning appliances (airco and ventilation).

**Movables:** Compression and both heat exchanges (for heat and for cooling) happen in the same small device placed in the room. The waste heat is generally blown away with a tube through a window.

**Single Split:** The compression of the working fluid and the heat release takes place outside the building. The expansion of the working fluid and the cooling takes place inside the building.

**Multi Split:** The difference to single split systems is the supply of working fluid to more than one room driven by one central cooling unit. This can be either a compressor or an absorption/adsorption chiller.

### **Photovoltaic driven compression cooling**

Electricity generated on-site by renewable energies can be used to operate compression cooling devices. These are technically the same as compression cooling devices operated with electricity from fossil power plants, with some additional control units in order to utilise the electricity generated on-site. Once feed-in prices for renewable electricity from onsite photovoltaic systems get lower than prices for electricity purchased from the utility an increasing interest in business models for using electricity produced onsite may occur. This may have an important impact on the operation of combined systems consisting of photovoltaic systems and compression cooling machines in such way that the self-consumption of locally produced electricity is maximised. Integration of a cold storage can help to maximise self-consumption. Most probably in future many installations using this model will show up both in private buildings – in particular in southern Europe – and in commercial buildings and tertiary sector applications.

### **Use of surrounding cold**

Another option is the direct use of the surroundings for cooling purposes. This could be the use of cold ground water for the cooling of buildings, which, however, is highly dependent on the surrounding conditions and has not, until now, been widespread. Therefore only thermally driven cooling systems operated with renewable energies are described further here.

### **Thermal cooling using renewable heat sources**

According to (Wiemken et al., 2013) the most common RES-cooling systems are solar driven systems. The cooling process can be either an open or closed cycle. Open cycles are primarily used for air-conditioning systems and directly condition the inlet air, while closed cycles can be used for different applications such as cold storage rooms or concrete core cooling. The options in open cycle cooling processes are:

- Liquid desiccants: reverse flow absorbers
- Solid desiccants: dehumidification rotors

In closed cycles, either solid (adsorption) or liquid (absorption) sorbents can be used. The use of liquids as sorbents usually involves two liquids with different evaporation points. According to (Wiemken et al., 2013) the following combinations are used in solar cooling systems:

- water/ lithium bromide
- water/ lithium chloride
- ammonia/ water

In adsorption cooling systems the solid sorbents are normally silica gel or zeolite and the refrigerant is water (see (Wiemken et al., 2013)). The main difference between adsorption and absorption cooling processes is that adsorption processes are periodical, while the solution in absorption processes is transported continually.

The cooling systems usually comprise a solar collector, a cooling cycle including evaporator and condenser and a cooling device. They can include additional thermal storages in order to be able to supply cold water even when the sun is not shining (e.g. during the night). In closed cycles a refrigerant is evaporated under low pressure allowing heat to be extracted from an external cycle (Wiemken et al., 2013). The refrigerant vapour is adsorbed/ absorbed by a sorbent and in order to avoid saturation of the sorbent, it is then separated from the refrigerant in a generator using (solar) heat. The refrigerant is then condensed and fed back to the evaporator and the sorbent is re-used in a closed cycle.

Temperatures of 5°C are possible with water-lithium bromide processes. In systems with ammonia as the refrigerant, temperatures below 0°C are possible (c.f. Wiemken et al., 2013). Until recently this technology was mainly used to supply process cooling. However, for a few years now, it has also been used for the cooling of buildings in combination with storage concepts (ice storage) or heat pumps using ambient air temperatures of less than 0°C.

The heat needed in the generator of the cooling cycle can be produced by normal solar collectors if only low temperatures are required, or by concentrating collectors, when driving temperatures above 140°C in processes with more than one stage are needed.

### 2.7.2 Technology characterisation

The efficiency of thermally driven cooling processes is usually given as the Energy Efficiency Ratio (EER), which is the equivalent of the Coefficient of Performance (COP) in heat supply systems (heat pumps). According to (Wiemken et al., 2013), thermally driven cooling processes have an EER of 0.5 to 1.8 depending on the temperature in the generator (low temperatures lead to low EERs, high temperature to higher EERs) and stages of the process (1, 2 or 3 stages). Table 32 summarises the main characteristics of different solar driven absorption cooling systems. The characteristics of solar driven adsorption systems are listed in Table 33.

For residential air conditioning the EER of movable and reversible split systems vary between SEER=3,15 electrical efficiency and 8,5.

Table 31: Overview of typical characteristics of compression cooling and direct cooling systems.

	Movables (Monoblock) (1)	Cool only split (1)	Reversible ground source heat pumps (2)	Direct air cooling, night time, (3)
EER	1,9 – 3,2*	2,5 – 4,3		5 - 19
SEER, Reversed heat pump operation mode			2,3 – 5,0 (2)	
SEER, Direct Cooling			10 - 19	2 - 14
SEER, Combined (rev. HP and direct cooling)			3,4 - 12	

\*effective EER can be lower due to backflow of warm air  
 Source: (1) Stiftung Warentest, test 6/2008, (2) Herkel, Kalz (2005), (3) Pfafferott J (2003)

From EuP Directive one can adapt certain elements for the EER assumptions. These measures depend on several conditions and assumptions on temperature. The EuP Directive has conducted detailed analysis.

Table 32: Overview of typical characteristics of solar driven absorption cooling systems.

Typical operating data	Absorption, Water/ Lithium bromide			Absorption, Ammonia/ Water
	Single-stage	2-stage	3-stage	Single-stage
Driving/ inlet temperature	75°C-95°C	140°C-180°C Water, Vapour	Vapour	85°C-240°C
Coldwater, outlet temperature	>6°C	>6°C	>6°C	-20°C->0°C
Coldwater, inlet temperature	27°C-35°C	27°C-35°C	27°C-35°C	25°C-45°C
EER	0.6-0.8	>1.0(1.4)	>1.4(1.8)	0.5-0.6
Nominal cooling capacity	>15 kW	>150 kW	>500 kW	>10 kW
Suitable collector technologies for solar-thermal driving	High-quality flat plate collector, Vacuum tube collector	Linearly concentrating collector	Linearly concentrating collector	Vacuum tube collector, Linearly concentrating collector

Source: Wiemken et al., 2013

Table 33: Overview of typical characteristics of solar driven adsorption cooling systems.

Product series	Adsorption, zeolite, silica gel			
	HTC	LTC	ACS	ADR-Z
Driving/ inlet temperature	85°C	72°C	55°C-95°C	68°C
Coldwater, outlet temperature	14°C	15°C	6°C-20°C	15°C
Coldwater, inlet temperature	27°C	27°C	22°C-37°C	27°C
EER	0.52	0.6	0.6	0.52
Nominal cooling capacity	18 kW	10 kW	8/15 kW	>110 kW
Suitable collector technologies for solar-thermal driving	High-quality flat plate collector, Vacuum tube collector			

Source: Wiemken et al., 2013

The investment costs of solar cooling systems (excluding installation and cold distribution) were between 4,500 €/kW for small applications (up to 10 kW) and 2,250 €/kW for large applications (from 50 kW) in 2011 (c.f. Jakob, 2012). Between 2007 and 2011 a cost reduction of 40 – 50% was achieved due to standardisation and technological improvements. The aim is to reduce the costs of solar driven cooling systems to 1,000 – 1,500 €/kW for medium and large scale systems and 3,000 €/kW for small scale systems (c.f. Jakob, 2012). Data on operation and maintenance (O&M) costs are



not available, but (Jakob, 2012) states that these costs are usually lower for solar thermally driven cooling systems than for conventional cooling systems. Solar cooling systems have a technical lifetime of 15 – 20 years (Jakob, 2012).

Based on data from SolarNext and Solem Consulting, (Jakob, 2013b) specifies the cost share of the solar collector at approximately 45% for small systems and at about 65% for large systems.

(Mugnier, 2014) uses the same cost figures. He states that payback time largely depends on boundary conditions as there are annual hours of operation for cooling, heating, hot water preparation and also competing conventional energy costs and climatic conditions. (Mugnier 2014) estimates that even in the best conditions a payback time shorter than 10 years would be very difficult to achieve.

### 2.7.3 Technology stock distribution

Residential air conditioners are limited by a capacity limitation. Therefore it is used a 12 kW limit in the labelling directive 2002/31/EC and for the Directive on Energy Performance of Buildings 2002/91/EC, where a lower limit to central air conditioning systems is put. The heating capacity is also limited by the cooling mode thermal capacity of 12 kW.

As might be expected, economy, population and climate relates to the number of units and number of products sold. Italy and Spain make up the largest part in Europe in both categories. They account more than the half of all sales and installed units. Further they hold more than 60% of the installed capacity Table 34.

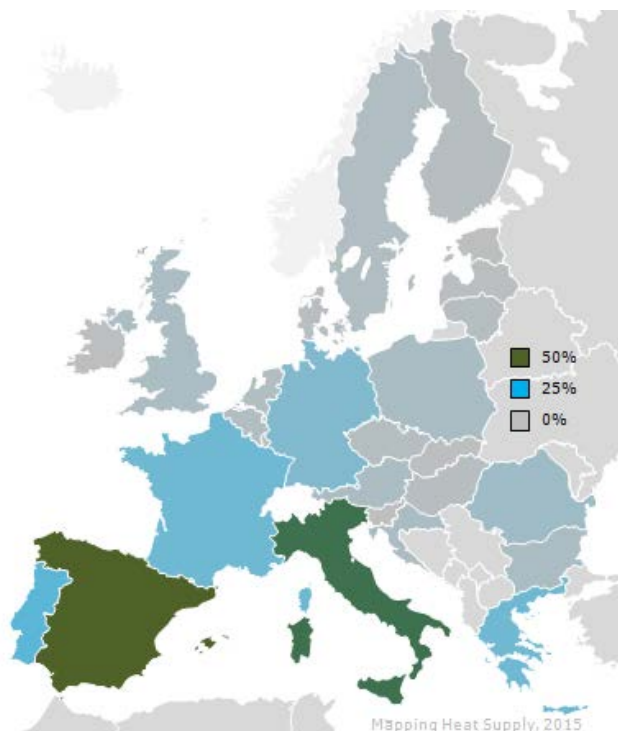
The distribution is made by moveable and non moveable air conditioner. The non-moveables are divided in cool-only units and reversibles which also can provide heating, hence the division between single and multisplit is not made. The residential market is dominated by reversible units which provide the highest number of units as well as the biggest installed capacity.

Table 34: Estimated installed capacity and number of units for EU-28 for Residential chillers (Movables, Reversible split, and only Cooling Split Units)

	Installed capacities (GW)	Number of units (units)
Moveable	16,63	7.466.149
Reversible split	100,59	19.058.536
Cool Only - split	18,31	3.466.987
Total	135,52	29.991.673

Source: own calculations IREES, 2015

Figure 21: Residential air conditioning stock in the EU-28.



Source: own calculations, IREES 2015

Whereas the estimated European air-conditioning market size was 5.2 Million sold units in 2012 (Jakob 2013a) the number of solar cooling installations in Europe totalled only about 800 in 2012, (Mauthner et al., 2015). This source reports 950 installations worldwide in 2012 with a growth rate of approximately 12% per year. Remarkably, the number of newly installed solar cooling systems decreased from 150 in 2011/2012 to approximately 50 new installations per year in Europe after 2012. (Jakob 2013a) cites two sources of documented and estimated numbers of worldwide installations of solar cooling systems. These data largely agree with the data of (Mauthner et al., 2015). The disaggregated data for the year 2009 cited by (Jakob, 2013a) from IEA Task 38 allows us to extrapolate the number of installations in seven European countries up to the year 2012. Table 35 shows the disaggregated number of installed solar cooling systems in European countries extrapolated from these sources.

In Europe, solar cooling systems are most notably installed in Spain, Germany and Italy (Mauthner et al., 2015), with approximately 370, 140 and 90 installed systems in 2012 (own calculations extrapolating data provided by Mauthner et al. (2015) and Jakob (2013a)). Austria, France, Portugal and Greece follow with approximately 60, 50, 25 and 15 installed solar cooling systems. The relatively large number of installed systems in Spain is based on the many new small scale installations (up to 10 kW) in the last few years (Jakob, 2013a).

In (Jakob 2013a), the cooling capacity of thermally driven chillers is estimated at 19 MW worldwide. He indicates 34% is provided by solar cooling, 44% by decentralised combined heating, cooling and power systems, 8% is district heating driven and 14% of the chillers are driven by waste heat. Aligning these numbers to the extrapolated stock data gives us an estimate of the installed cooling capacity for solar cooling in the EU 28 of 5 to 6 MW.

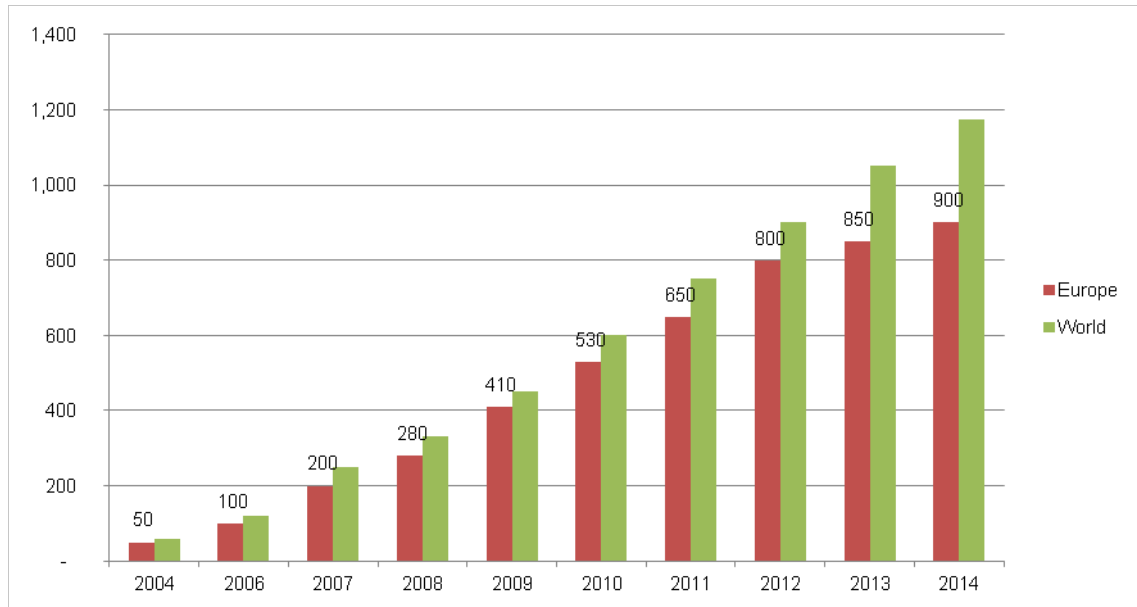
Table 35: Stock of solar cooling systems in European Countries, # of installed systems, 2012.

	<10 kW	>10 kW	Total	Installed cooling capacity
Austria	26	35	61	
France	12	35	47	
Germany	67	73	140	
Greece	-	15	15	
Italy	29	61	91	
Portugal	12	15	26	
Spain	301	70	371	
other EU	18	32	50	
<b>EU-28</b>	<b>464</b>	<b>336</b>	<b>800</b>	<b>ca. 5-6 MW</b>
Methodology: interpolation/ extrapolation	Sources: (Jakob, Uli, Status and Perspective of Solar Cooling in Europe, Presentation given at the Australian Solar Cooling 2013 Conference, Sydney, 12/04/2013), (Mauthner, Franz, Werner Weiss and Monika Spörk-Dür; Solar Heat Worldwide; IEA Solar Heating & Cooling Programme, Gleisdorf (Austria), June 2015)			

Regarding the share of the cooling technologies applied in solar cooling systems, (Jakob 2013b) and (Mugnier 2014) provide statistics from the European Academy of Bozen/Bolzano (EURAC), indicating a 71% market share for absorption chillers, 13% for adsorption chillers, 12% for solid desiccant cooling, and 2% for liquid desiccant cooling in the year 2009.

Given that only 50 solar cooling systems had been installed by 2004, in 2012 almost 100% of the systems were younger than 10 years old, and 75% of the installations were less than 5 years old (Mauthner 2015).

Figure 22: Market development 2004-2014 solar air conditioning and cooling systems in Europe (indicating numbers of installations) and world-wide.



Source. Mauthner 2015

## **3 Process heating and cooling technologies**

### **3.1 Steam generation - Steam systems and steam boilers**

According to the assessment in WP 1, the generation of steam incl. CHP (100-500°C) consumed about 700 TWh in 2012 in the EU28, which is about 22% of the total final energy demand in the EU industry. This underlines the high relevance of improving the deployment of renewable energies as well as the energy efficiency of steam systems. Section 3.1 provides an overview of the main technological features of steam systems as well as steam boilers, whereas section 3.2 focuses on steam and hot water generation in combined heat and power (CHP) applications.

#### **3.1.1 Scope and description of technology**

Steam is one of the most important energy carriers in industry alongside electricity, gas and compressed air. It is generated by heating water beyond its boiling point. Depending on the temperature and pressure conditions, several types of steam can be distinguished:

- Wet (unsaturated) steam: Molecules are in the gaseous state and mixed with tiny water droplets.
- Saturated (dry) steam: All water molecules are in the gaseous state.
- Superheated steam: Saturated steam is heated even further.

Steam is broadly used in industry as a source of thermal energy, e.g. as an input for production processes (Table 36) and for heating purposes (Therkelsen et al. 2013).

Table 36: Examples of steam utilisation in different sectors.

	Fractionation, distillation	Drying	Power for drives, machinery	Evaporation, concentration	Heating process air, water storage tank	Hydrogen generation	Agitation/blending	Cracking	Sterilisation
Chemical industry	x	x	x	X	x	x	x	x	
Medical	x		x						x
Petroleum refining	x		x		x	x	x	x	
Pulp and paper		x	x						
Steel production			x	x	x				
Metal casting			x	x	x				
Forest product			x		x		x		
Food processing		x	x	x					x
Agriculture			x						x
Medical			x						
Textile		x	x	x					
Glass			x		x				

Source: Gentili et al. 2014

Sectors like the chemical, paper, food, refining and metal industries have a relatively high share in steam boiler capacity. In the United States, for example, these five sectors represent about 82% of installed steam boiler capacity (ETSAP 2010). Specific applications of steam in the pulp and paper industry include drying processes in paper machines, for instance. In the food industry, as another sector with a comparatively high share of steam usage, steam is used for cooking, blanching, sterilisation, drying and other purposes.

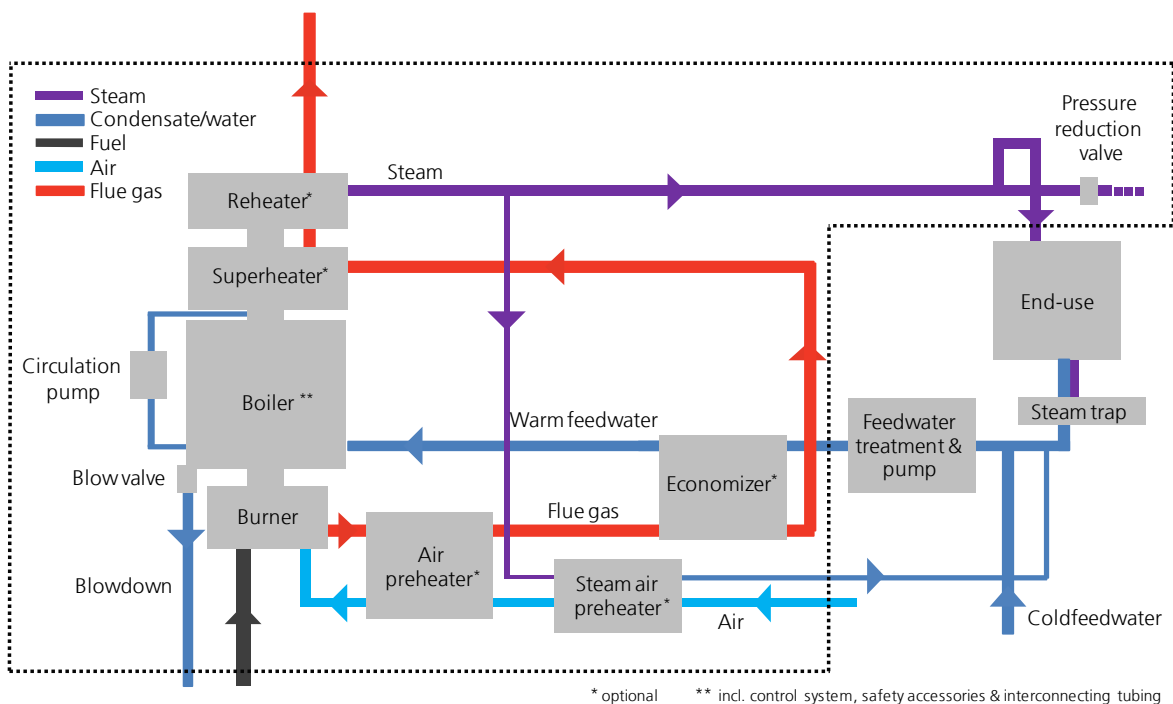
Steam systems encompass steam generation, distribution, utilisation and recovery which can be described as follows (based on Gentili et al. 2014):

- **Generation:** Steam is generated by heating water using heat from combustion processes or from a heat recovery system. This heat transfer takes place in a steam boiler. Due to the supplied energy, water starts to boil and changes its phase from a liquid to a gaseous state. The energy content of the generated vapor, i.e. steam, can be raised by further increasing its temperature.
- **Distribution:** The distribution system is a transfer channel for steam that links the generation part, i.e. the steam boiler, to the end-use equipment. The end-use equipment is connected to the distribution system via take-off lines. These take-off lines may operate at different pressures. Common equipment used in the distribution system are isolation pipes, valves and, in some cases, back-pressure turbines which allow to concurrently reduce the pressure in the line and thereby gain mechanical energy.
- **End-use:** As shown above, there is a large range of utilisations for steam. Typical enduses include fractionating towers, strippers, heat exchangers or chemical reaction vessels. Steam may also be used for carrying chemical substances, e.g. in the chemical industry.
- **Recovery:** If possible, steam is fed back into the boiler as condensate after its

utilisation. For this purpose, the condensate is collected in a tank and then pumped from there to a deaerator, where oxygen and non-condensable gases are extracted. Finally, a boiler feed pump increases the feed water pressure to reinject the condensate into the boiler. Due to losses, fresh makeup water and additives are usually added in the collection tank or the deaerator.

The system boundary used for the steam systems in this study is depicted by the black dotted line in Figure 23. This illustration shows that both the generation and distribution part of the steam system are analyzed here. The end-uses and the recovery of steam systems, however, are not considered as these are technologically even more heterogeneous than steam generation and distribution. Furthermore, all steam systems fed by boilers with a thermal output between 0.1 and 50 MWth are considered as steam systems in the context of this study with the exception of waste heat boilers.

Figure 23: Illustration of the system boundaries used in this study for steam systems.



Source: based on Gentili et al. 2014

The steam boiler is a central part of any steam system. This term is used for a closed vessel in which water is heated to generate steam. There are various types of steam boilers used in industry. A typically used technical classification of these boilers is based on the flow of the media through the boiler. This results in a distinction between fire-tube and water-tube boilers. The essential difference is that, in the former, hot combustion gases flow through tubes, thus heating a reservoir of water, while in the latter, the gas flows around a set of pipes filled with water. Both types of boilers have specific advantages and disadvantages.

Fire-tube boilers are usually competitive for steam generation up to 28 tons of steam/hour and pressures up to 30 bars. They can be operated with oil, gas or solid fuels. At present, most fire-tube boilers are shop-fabricated for all fuels for economic reasons. The major advantages of fire-tube boilers are their relatively low cost, ease

of cleaning, compactness, easy replacement of tubes and their suitability for supplying both space heating and industrial processes. Yet they also have some limitations in terms of their suitability for high pressure applications above 25 bar and high capacity steam generation (Gentili et al. 2014).

Water-tube boilers are generally selected in cases of high steam demand and high pressure requirements. Most modern designs have a capacity in the range of 4.5 to 120 tons of steam/hour and high pressures up to approximately 250 to 260 bar. Supercritical boilers can even provide pressure levels above 350 bar. The advantages of water-tube boilers include large boiler capacities, higher pressure levels and the ability to provide very high steam temperatures up to 650 °C. Their major disadvantages include high initial costs and more complicated maintenance requirements (Gentili et al. 2014).

Apart from this classification based on boiler design, other approaches can be used to group different types of steam boilers. While a technical classification may be needed for engineering purposes, the objective of this project is to map the use of fuels and energy efficiency in heating and cooling technologies. Therefore, it is helpful to distinguish steam boilers by the type of energy carrier. Correspondingly, the following classification of steam boilers is used for this study:

- Gas-fired steam boilers,
- Coal-fired steam boiler,
- Oil-fired steam boilers,
- Biomass-fired steam boilers, and
- Electric steam boilers.

Generally, there is very little information available concerning the potentials for using biomass (e.g. pellets) or about fuel-switch options to renewable energies for steam boilers. Most of the steam boilers in Europe are currently expected to be operated using natural gas (see Table 41), while the share of biomass as a fuel is only a few percent on average. However, this average is not representative of the entire European market as some countries like Denmark tend to rely on solid biomass boilers, according to information from the Ecodesign process on Steam Boilers. It has also been pointed out in the corresponding study by Gentili et al. (2014) that the importance of biomass is growing. Steam boilers operating with renewable energies such as biomass are becoming competitive to fossil-fuel boilers according to ETSAP (2010). Furthermore, Gentili et al. (2014) also report that gasification technologies are being developed that may allow the use of different types of fuels and a fast adaptation to other fuels. Some installations are already using this technology. Installing dual-fuel burners also offers the potential to use additional fuels other than gas.

As pointed out above, the distribution system is also part of the analysis. The technical details of a steam distribution system vary depending on numerous technical parameters and characteristics. As this project focuses on overall potentials, the distribution systems will be modelled as a generic part of a steam system.

### **3.1.2 Technology characterisation**

When researching steam systems in Europe, it has to be acknowledged that data are relatively scarce concerning installed capacities, energy demand, saving measures and the potentials for the use of renewable energies/fuel-switch options. While there are some data for other regions of the world, especially the United States, the most relevant and recent source for Europe is the Ecodesign Preparatory Study on Steam Boilers (ENTR Lot 7: Gentili et al. 2014). To extend the knowledge on steam systems in Europe, a survey based on a two-page questionnaire was developed within this study for technical and market experts. This questionnaire was provided to national experts



in various Member States with the kind support of the Association of the European Heating Industry (EHI). Unfortunately, the experts were unable to provide feedback on the current situation of steam boilers within Europe. Therefore, the subsequent analysis is based on a combination of findings from the literature and statistical data. The technological characterisation is structured along the input information required for the modelling activities within this project.

The efficiency of technical equipment is a main parameter for technological modelling. Various metrics can be used to describe the efficiency of steam systems. Within this study, two efficiencies are used to describe a steam system: One is used for the steam generation, i.e. the steam boiler, and another for the steam distribution system. As the distribution system is downstream to the generation system, the generation and distribution systems' efficiency values can be multiplied to estimate the overall efficiency of the system according to the defined system boundaries.

The thermal efficiency of the steam boiler is used to describe the efficiency of the generation system, i.e. the thermal output of the steam boiler divided by the energy input required for its operation. The thermal efficiencies of steam boilers generally depend on factors such as the type, size, age and primary function of the boiler, the supplied steam pressure level, and the supplied fuel, etc. In the Ecodesign Preparatory Study, ten steam boiler types were defined as representative for the European stock of steam boilers. Steam boilers fired by natural gas combining different sizes, pressure levels and types were chosen as a representative proxy for the European boiler population (Table 37). For each of these types, a base case efficiency was defined, i.e. the efficiency of the bare boiler without any additional efficiency options. In addition, the thermal efficiency of the current boiler stock was provided for each type. This value is higher than the base case efficiency as a proportion of the boiler stock is already equipped with energy-efficiency measures as discussed below. Note that some sources like ETSAP (2010) indicate efficiency values of between 70 and 85% depending on the fuel type; these values are lower than the bare boiler values indicated in Table 37. However, as no comparable detailed information is available on these efficiency values, the values from the European Ecodesign study are adopted here.

Table 37: Efficiency characterisation of natural gas-fired boilers as representative for steam boilers, taken from Gentili et al. 2014.

	Thermal efficiency stock [%]	Thermal efficiency bare boiler [%]
Very small fire-tube steam boiler, low pressure [2.5 MW <sub>th</sub> ; 15 bar]	91.1	87
Very small fire-tube steam boiler, high pressure [2.5 MW <sub>th</sub> ; 25 bar]	90.1	86
Small steam fire-tube steam boiler, low pressure [7 MW <sub>th</sub> ; 15 bar]	91.1	87
Small steam fire-tube steam boiler, high pressure [7 MW <sub>th</sub> ; 25 bar]	90.2	86
Medium fire-tube steam boiler, low pressure [20 MW <sub>th</sub> ; 15 bar]	91.2	87
Medium fire-tube steam boiler, high pressure [20 MW <sub>th</sub> ; 25 bar]	90.2	86
Large fire-tube steam boiler, low pressure [35 MW <sub>th</sub> ; 15 bar]	91.3	87
Large fire-tube steam boiler, high pressure [35 MW <sub>th</sub> ; 25 bar]	90.4	86
Large water-tube steam boiler, low pressure [35 MW <sub>th</sub> ; 15 bar]	89.4	85
Large water-tube steam boiler, high pressure [35 MW <sub>th</sub> ; 25 bar]	88.4	84

Source: Gentili et al. 2014.

Apart from the boiler, the efficiency of the system also depends on steam distribution.

Steam distribution systems are very heterogeneous and their efficiency is influenced by many factors such as the size of the system, its layout, the connected end-uses, pressure and temperature levels or the piping material, its length, diameter and insulation. Representative information for these parameters and their actual impacts on a distribution system's efficiency is generally not available and also very difficult to generate due to technological heterogeneity, making it necessary to rely on data from only a few sources. Losses in distribution systems are typically accounted for when describing the efficiency of the distribution system. To do so, the amount of energy delivered by the distribution system (output) is compared to the amount of energy that is fed into the distribution system by steam generation (input). Swagelok (2011) indicates losses due to insufficient insulation of 6.4% and steam leaks of 7.5%. The resulting efficiency value of a steam distribution system is therefore estimated at 86.1%. Distribution losses in the US are estimated at a similar value of 15% by Energetics et al. (2004). Combining the two values for generation and distribution yields an estimate of the overall thermal efficiency of a steam system.

There are many options to improve the efficiency of current steam systems, shown in planning manuals, guidelines for specific branches and the technical literature, e.g. Therkelsen et al. (2013); US DOE (2012); EPA (2010); Kramer et al. (2009); Einstein et al. (2001). Table 38 illustrates different measures excluding end-uses that are distinguished in the US American Industrial Assessment Center Database.

Table 38: Examples of energy-efficiency measures for steam systems (excluding end-uses) based on the US American IAC database.

	Organisational measure (incl. maintenance)	Technological add-on	Technological replacement
Generation	Keep boiler tubes clean Move boiler to more efficient location Operate boilers on high fire setting Reduce excessive boiler blowdown Use minimum steam operating pressure Analyze flue gas for proper air/fuel ratio Establish burner maintenance schedule for boilers Repair faulty insulation in furnaces, boilers etc.	Install turbulator Direct warmest air to combustion intake Minimise boiler blowdown with better feedwater treatment Use heat from boiler blowdown to preheat boiler feedwater Flue gas to preheat feedwater Preheat combustion air with waste heat Waste heat from hot flue gases to preheat combustion air Install waste heat boiler to produce steam Use waste heat from hot flue gases to generate steam Substitute air for steam to atomise oil	Replace obsolete burners with more efficient ones Replace boiler Install smaller boiler
Distribution/recovery	Repair/replace steam trap Turn off steam tracing during mild weather Close off unneeded steam lines Use correct size steam traps Shut off steam traps on superheated steam lines not in use Increase amount of condensate returned Lower operating pressure of condenser (steam) Eliminate leaks in high pressure reduction stations	Install steam traps Install/repair insulation on condensate lines Insulate feedwater tank Install deaerator in place of condensate tank Flash condensate to produce lower pressure steam Waste process heat to preheat makeup water Use steam condensate for hot water supply (non-potable)	-
Overall system	Repair faulty insulation Repair leaks in lines and valves Repair and eliminate steam leaks Reduce excess steam bleeding	Insulate steam/hot water lines Substitute hot process fluids for steam Use heat exchange fluids instead of steam in pipeline tracing systems	-

Source: Rohde et al. 2014

Due to the abundance of measures to improve energy efficiency, a set of the most relevant measures for steam generation was analyzed in the Ecodesign preparatory study with detailed information on their costs, impacts and current status on the market. These measures are adopted in this study and are based on the use of an economiser and a combustion control to reduce thermal demand and a variable speed drive to lower electricity demand. The options can be described as follows (Gentili et al.

2014):

- **Economiser:** An economiser can reduce the energy demand of a steam boiler by using flue gases to preheat the feedwater of the boiler. This requires the installation of an additional heat exchanger. Installing an economiser can typically increase the energy efficiency of the boiler by 5.5 percentage points. The costs for this option vary with boiler size, from about 6,000 euros per MW of thermal capacity for very small boilers to 2,000 euros/MW<sub>th</sub> for large boilers due to economies of scale.
- **Combustion control:** This measure automatically adjusts the flow rate of combustion air supplied to the boiler. More complete combustion of the fuel can be achieved under more favorable stoichiometric conditions. In an ideal case, no oxygen remains in the flue gas after combustion. As ambient conditions change, the combustion air changes its properties, as well. The combustion settings in boilers without automated combustion control have to be set to the most unfavorable weather conditions. This regularly results in non-optimised combustion. In an automated control system, the oxygen and carbon monoxide content in the exhaust gas are monitored and the volume of combustion air is optimised. Thus heat losses due to an unnecessary amount of air in the combustion or flue gas can be minimised. The required investment has been estimated at about 30,000 Euros per steam boiler and the achievable efficiency improvement at about 1.75 percentage points.
- **Variable speed drive:** When a steam boiler is operated under part load conditions, it requires less air for combustion. If a boiler is not equipped with a speed control to provide the combustion air, the flow of air has to be regulated by dampers. As an alternative, the use of a variable speed drive can help to adjust the flow volume by regulating the speed of the fan system, thereby avoiding excessive air flow. As a consequence, the energy demand of the fan system can be reduced by approximately 55%, assuming an average load of 75%. This option is generally expected to be cost-effective.

An air preheater as an additional thermal option can also improve boiler efficiency but was excluded from the Ecodesign study due to possibly detrimental environmental effects as a consequence of increased NO<sub>x</sub> production (Aydemir et al. 2015b). Table 39 provides a summary of the efficiency options for boilers.

Table 39: Efficiency improvements and diffusion of efficiency options in steam boilers.

	Economiser	Combustion control	Variable speed drive
Efficiency increase [%pt]	5.5	1.75	related to electricity
Investments [Euro/MW <sub>th</sub> ]	2,000-6,000	1,000-12,000	n.a.
Market share 1993 [% of sales]	50	13	5
Market share 2013 [% of sales]	80	60	50
Share in stock 2013 [% of stock]	64	32	21

Source: Values based on Gentili et al. 2014; Aydemir et al. 2015a

Energy-efficiency improvements to the distribution systems of steam boilers are difficult to specify on a technological basis as the systems are very heterogeneous and there are so many ways of improving them. Therefore, a top-down approach is used instead. It is assumed that the distribution system could achieve a maximum efficiency of 95% as it is unlikely that zero losses occur in a steam distribution system,

even under optimum conditions. This leaves a total improvement potential of 8.9% percentage points when compared to the given efficiency level of 86.1%.

Besides the efficiency of steam systems and its improvement options, their operating hours have a large influence on their total energy demand. Operating hours generally depend on factors such as production schedules, the characteristics of steam usage and the technical setup of the steam generation system. The annual operating hours of a steam boiler are estimated at 1,250 hours on average (Gentili et al. 2014). It should be noted that this average covers permanently operated base-load boilers as well as temporarily operated boilers such as peak load or stand-by systems.

Apart from technical data, economic data is also required for modelling steam systems. It is even harder to find relevant economic data, but some are provided in the Ecodesign study. An approximation based on data from this study allows a rough estimation of the specific price per kWh<sub>th</sub> as a function of its thermal capacity. Using the information from Gentili et al. 2014 on boiler costs, average specific steam boiler prices can be calculated for the EU28. However, the resulting specific costs per output power appear to be very low as compared to similar technologies such as other natural gas boilers. For this reason, specific costs derived from Erdmann and Dittmar (2010) are used as more plausible proxy values instead. Source: own calculation

To take price differences among Member States into account, differentiated price levels are derived using information on the comparative price levels for machinery and equipment provided in Eurostat (2015a).

With regard to annual expenditures for operation and maintenance excluding energy costs, ETSAP (2010) provides an indicative value for operation and maintenance amounting to about 1% of the life-cycle costs of a boiler. This indication underlines that the costs of operation and maintenance tend to be of minor importance with regard to a life-cycle assessment. Gentili et al. (2014) provide values which relate the costs of operation and maintenance to the actual boiler unit costs. According to their data, this value is about 3 to 4% of the steam boiler costs, depending on the boiler type.

### **3.1.3 Technology stock distribution**

Information on the distribution of the stock of steam boilers is only available as a European aggregate figure from the Ecodesign study on steam boilers. Data on the level of a specific country in Europe are generally not available in the statistics nor in the scientific literature. In addition, the Ecodesign study on steam boilers only provides stock data on boilers in the capacity range of 1 to 50 MW<sub>th</sub>. Relying on additional assumptions and calculations to provide a characterisation of the technological stock by country and fuel is therefore necessary as described below.

Table 40: Estimates of annual EU 28 steam boiler production in terms of units by PRODCOM<sup>2</sup> category as provided by BDH-EHI<sup>3</sup> in the Ecodesign preparatory study.

	Water-tube boilers	Vapor generating boilers	Super-heated boilers
Very small to small [1-5 MW <sub>th</sub> ]	400	1,500	25
Small to medium [5-25 MW <sub>th</sub> ]	300	750	175
Medium to large [25-50 MW <sub>th</sub> ]	300	250	50
Total	1,000	2,500	250

Source: Gentili et al. 2014.

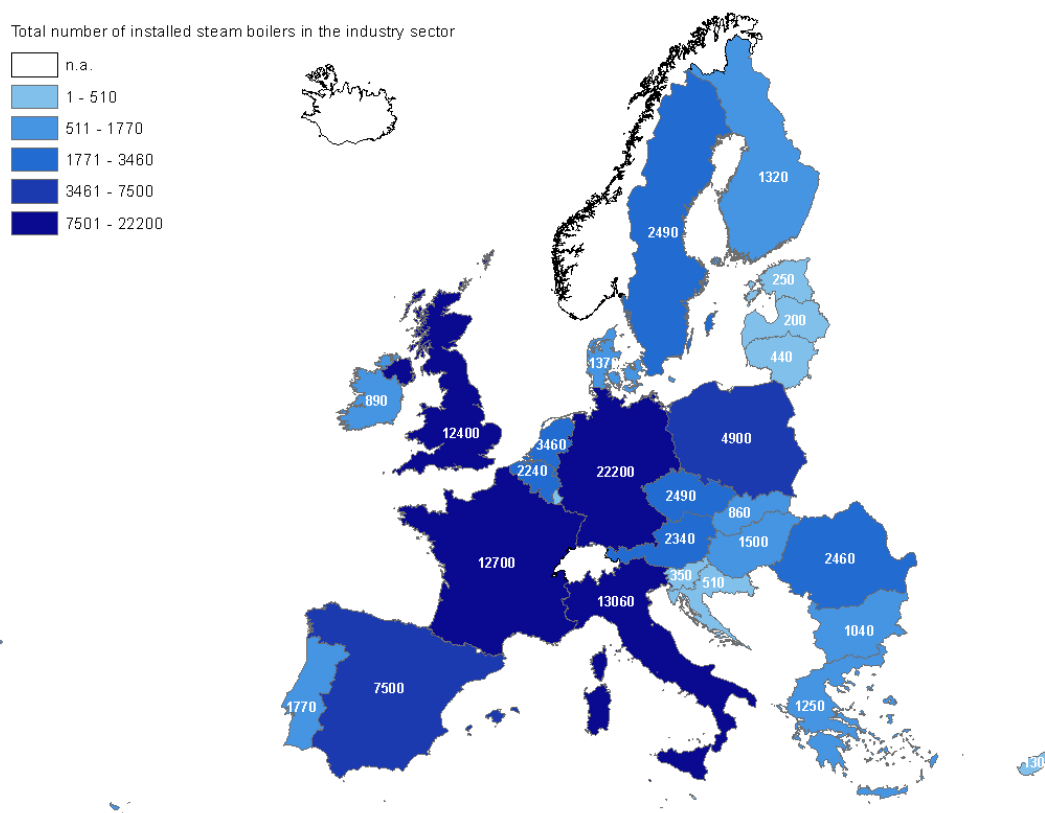
The lifetime of a steam boiler is a key parameter for determining the current stock of steam boilers. Steam boilers are used heterogeneously in industry. As a result, the lifetimes of steam boilers vary widely. While in the Ecodesign Preparatory Study, an average lifetime of 25 years is used to calculate the environmental impact (Gentili et al. 2014), it is also mentioned that lifetimes vary considerably depending on the size of boilers. ETSAP (2010) points out that the technical lifetime of a boiler can range from 25 up to 40 years and more: More than three quarters of the boiler population in the United States, for example, are older than 30 years. A similar result is shown in EEA (2005) for the industrial and commercial hot water and steam boiler stock in the US. In line with the calculations carried out in the Ecodesign study, an average lifetime of 25 years is used for the stock calculation in this study.

---

2 PRODCOM is a European database with statistics on the production of manufactured goods on a Member State level.

3 European Heating Industry/Bundesverband der Deutschen Heizungsindustrie e.V.

Figure 24: Illustration of the steam boiler stock (quantity of boilers) in EU28 countries in 2012.



Source: own calculation

Apart from information on the typical lifetime, sales figures are also required for stock estimation. Current production figures were published in Gentili et al. (2014). In line with the information provided there, an export share of 20% is assumed and historical sales are based on a backcasting approach using the relative development of GDP as given in Eurostat (2014). In conjunction with the information on lifetime, this enables an estimate of the current stock of steam boilers. Because the data from the Ecodesign study only include boilers above 1 MW<sub>th</sub>, while the study also deals with smaller boilers above 0.1 MW<sub>th</sub>, it was assumed that the boiler segment between 1 and 50 MW<sub>th</sub> make up about 60% of all boilers and that 40% have a capacity in the range between 0.1 and 1 MW<sub>th</sub>. Based on these figures, a total stock of almost 100,000 units is estimated for the EU28. As shown below, it should be noted that the segment between 0.1 and 1 MW<sub>th</sub> has only a minor impact on installed steam boiler capacity when compared to the group of larger steam boilers.

The total stock of boilers for the EU28 needs to be further broken down by country and fuel. The breakdown by country is based on information from various European statistics using a combination of price level indices for machinery and equipment (Eurostat 2015a) and the statistics on employees in industry per country (Eurostat 2015b). The results of this are illustrated Table 42. According to this estimate, about two thirds of the total boiler stock (about 68,000 boilers) are located in Germany, Italy, France, the UK and Spain.

For the breakdown by fuel, additional assumptions are required. ETSAP (2010) indicates that more than half the boilers in industrialised countries use natural gas as the primary fuel. Similarly, the calculation by Gentili et al. (2014) uses gas as the primary fuel for their study. For a further breakdown by fuel, a set of assumption on the aggregate fuels by boiler in the EU28 is necessary as shown in Table 41.

Table 41: Assumed share of energy carriers used in the total boiler stock across all EU28 Member States in 2015.

	Oil	Gas	Coal	Biomass	Electricity	Total
Micro boilers [0.1-1 MW <sub>th</sub> ]	15%	74%	5%	5%	1%	100%
Very small to large [1-50 MW <sub>th</sub> ]	15%	70%	0%	5%	10%	100%

Source: own assumptions with modifications after review by EHI

While the group of boilers between 1 and 50 MW<sub>th</sub> is expected to be mainly fired by gas, electricity is assumed to be more important for boilers below the 1 MW<sub>th</sub> threshold. The values provided as an average are then combined with statistical information on energy carrier usage (Eurostat 2015c) in the five core sectors of industrial steam usage (see Einstein et al. 2001), i.e. in 'petroleum refineries', 'iron and steel', 'chemical and petrochemical', 'paper, pulp and print' as well as 'wood and wood products'.

This information can be used to generate a detailed inventory of fuel use per country as shown in Table 42. In terms of numbers, approximately 70% of the boilers considered are gas-fired, followed by oil and electric steam boilers.



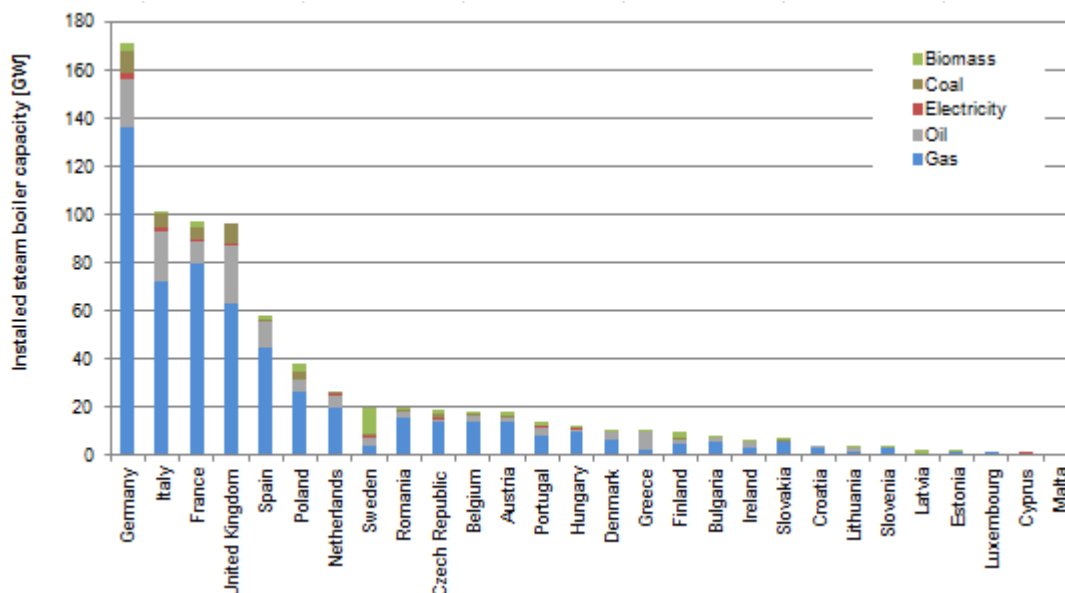
Table 42: Stock of steam boiler units by fuel type for the EU28 Member States in 2012.

	Oil	Gas	Coal	Biomass	Electricity	Sum
Austria	200	1,800	60	200	80	2,340
Belgium	200	1,800	60	80	100	2,240
Bulgaria	200	700	10	90	40	1,040
Croatia	100	400	0	0	10	510
Cyprus	70	0	0	0	60	130
Czech Republic	90	1,900	200	200	100	2,490
Denmark	400	800	0	100	70	1,370
Estonia	0	200	0	40	10	250
Finland	200	600	20	400	100	1,320
France	1,200	10,200	400	400	500	12,700
Germany	2,700	17,400	700	400	1,000	22,200
Greece	1,000	200	0	10	40	1,250
Hungary	200	1,200	20	10	70	1,500
Ireland	300	400	0	100	90	890
Italy	2,600	9,100	400	60	900	13,060
Latvia	10	80	0	100	10	200
Lithuania	200	200	0	20	20	440
Luxembourg	0	200	0	0	10	210
Malta	0	0	0	0	60	60
Netherlands	700	2,600	70	0	90	3,460
Poland	600	3,400	300	400	200	4,900
Portugal	400	1,000	0	300	70	1,770
Romania	300	2,000	50	30	80	2,460
Slovakia	60	700	50	30	20	860
Slovenia	10	300	0	20	20	350
Spain	1,300	5,700	100	200	200	7,500
Sweden	400	500	90	1,200	300	2,490
United Kingdom	3,100	8,000	600	0	700	12,400
EU28	16,540	71,380	3,130	4,390	4,950	100,390

Source: own calculation

As a last step, these stock numbers need to be converted into installed capacity. For this purpose, the number of boilers per category is multiplied by an average power per class (classes according to Table 40 plus 0.1 to 1 MW<sub>th</sub> class). For the class of boilers with a thermal output between 1 and 5 MW<sub>th</sub>, the corresponding value would thus be 3 MW<sub>th</sub> for example. The results of this calculation are shown in Table 42 and illustrated in Figure 25. Based on the input data detailed earlier, the overall capacity of steam boilers can be estimated at roughly 770 GW<sub>th</sub>. It should be noted that the relatively large number of boilers with a capacity up to 1 MW<sub>th</sub> only make up about 3% of the total installed capacity.

Figure 25: Steam boiler capacity by Member State and fuel for the EU28 Member States, ranked by thermal output capacity [GW<sub>th</sub>].



Source: own calculation

To conclude, it should be noted that there are hardly any reliable and detailed data on the technological stock, energy demand, energy efficiency measures and fuel switch options for steam systems. The figures given above can only provide indications of the current status of steam boilers/steam systems. Improving the availability of primary data on steam systems and collecting relevant data would be hugely beneficial to be able to conduct more reliable analyses and projections with regard to the type and amount of energy consumed by steam systems.

Based on the analysis of steam system carried out here, the following recommendations can be made, especially with regard to data collection:

In terms of general data collection, the categorisation of steam boilers in the PRODCOM database, though partially used in this study and the Ecodesign study, is misleading. While the European PRODCOM database provides figures for three different products classed as water-tube boilers (code 2530 1110), vapor generation boilers (code 2530 1150) and super-heated water boilers (code 2530 1170), the corresponding figures provided by the European production database are too high. Rohde et al. (2014) therefore suggests transferring boiler capacity data from the United States to Europe to obtain more realistic results. A preferable option would be the availability of more detailed and accurate European data that includes production, exports and imports.

One possibility could be to reconsider the currently used categories in the PRODCOM database that also cover steam boilers which can then be used as a proxy for characterising steam systems. The categories could be more clearly labelled as steam boilers and/or possibly include an indication of boiler size, especially with regard to distinguishing between relatively small and large boilers. However, first of all, it would be necessary to check whether the currently relatively small market with only a few producers of steam boilers would allow the corresponding figures to be published.

A second option is to improve collection of the relevant data through research projects and campaigns that allow a further characterisation of steam systems, e. g. the Hori-

zon 2020 project Steam Up<sup>4</sup>.

Thirdly, there is little evidence of the actual relevance of different energy-efficiency measures for steam systems in Europe and no structured data. In the United States, the Industrial Assessment Database provides a large set of different measures that have been applied in the last decades within energy audits to improve industrial energy efficiency. The corresponding information in Europe is often not published or at best available in databases of national or regional programs. Setting up and maintaining an overarching database with information about energy-efficiency measures for steam systems in Europe could provide further evidence of the current steam usage and help to identify improvement potentials in the long term.

---

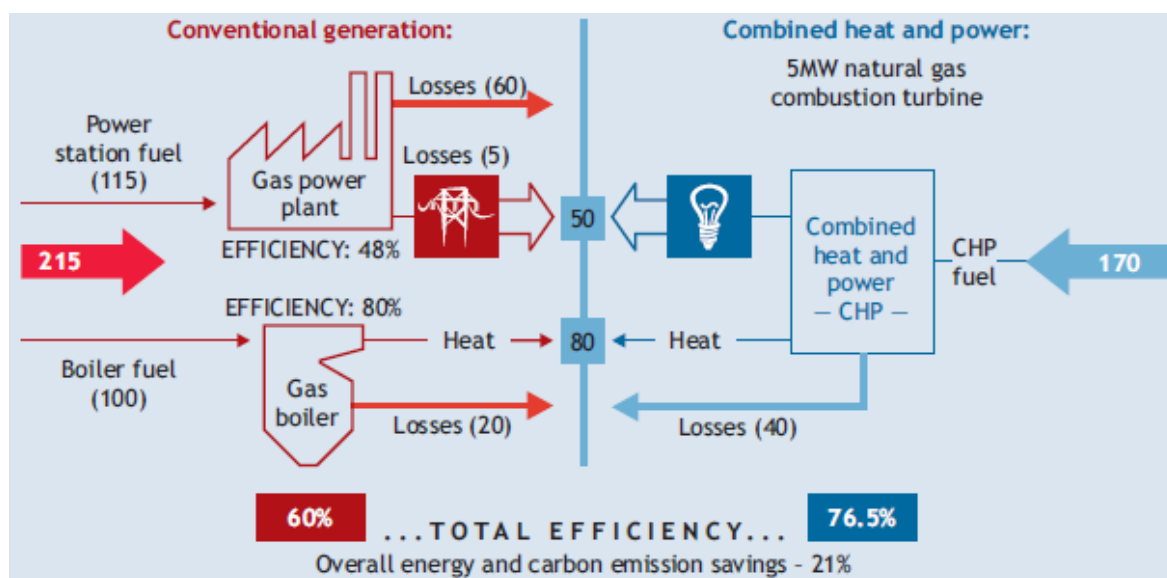
<sup>4</sup> [www.steam-up.eu](http://www.steam-up.eu)

### 3.2 Steam generation - Combined heat and power (CHP)

#### 3.2.1 Scope and description of technology

Combined heat and power (CHP) describes technologies used to generate electricity and usable heat in a single process based on primary energy inputs. It is also known as cogeneration. The use of waste heat from electricity generation substantially increases the overall efficiency of the process compared to that of electricity-only generation, although the use of waste heat reduces the electrical efficiency. CHP plants generally convert 75 – 80% of the primary energy into useful energy, while the most modern CHP plants reach efficiencies of 90% or more (IPCC 2007). In terms of primary energy and CO<sub>2</sub> emissions, the combined process is more efficient than individual heat and electricity generation and savings of around 20% can typically be achieved – depending on the individual plants and the reference case. An example of a comparison of CHP versus individual heat and electricity supply, is provided in Figure 26. In 2012, the average overall efficiency of all CHP plants in the UK was little lower than the above cited values and reached 72%.

Figure 26: Schematic comparison of CHP generation with individual heat and power generation.



Source: IEA 2008

Cogeneration technology is used for various types of applications, in all sectors, in small and large capacities as well as with different fuel types. Currently, natural gas is the predominant fuel type used; however, CHP units also provide a good opportunity to introduce renewable energy sources such as biomass. The major share of cogeneration plants are found in industry, district heating and in small commercial or residential applications. The focus of this chapter is on industrial CHP.

As CHP technologies largely provide heat and steam below 500°C, their use is mostly in the industrial sectors demanding low and medium temperature heat. These are the chemical industry, pulp and paper industry as well as food production. Industrial CHP plants are often large systems of several MWth, which typically use steam or gas turbines.

### 3.2.2 Technology characterisation

Techno-economic data was collected for the following CHP technologies.

The ratio of electricity to heat produced varies inter alia by type of technology. Typical power to heat ratios range from 0.45 (Steam turbines), 0.55 (gas turbines) to 0.95 (Combined cycle gas turbines) or even above 1.00 (European Commission 2009). They can however, also range substantially for individual technologies depending on the operation mode (e.g. by optimizing electricity generation). Observed real-life power to heat ratios can be different. For the UK, very comprehensive data is available on the overall stock of CHP installations from the Department of Energy and Climate Change (2015a). Accordingly, power to heat ratios range from 0.2 for steam back-pressure turbines to 0.45 for gas turbines, 0.51 for combined cycle technology and 0.68 for internal combustion engines. In the UK, the average power to heat ratio was 0.48 across all technologies in 2014 (Department of Energy and Climate Change 2015a). See Table 43 for a complete overview on the performance of the entire UK CHP stock, of which most is used in industrial sectors.

Table 43: Average Summary of CHP performance in the UK in 2014 as average across all plants (source: Department of Energy and Climate Change 2015a).

CHP technology	Operating hours per year	Electrical Efficiency	Thermal efficiency	Overall efficiency	Power to heat ratio
Back pressure steam turbine	4,260	13	65	78	0.20
Pass out condensing steam turbine	2,325	13	56	69	0.23
Gas turbine	5,382	23	51	74	0.45
Combined cycle	3,208	24	47	71	0.51
Reciprocating engine	3,515	25	37	62	0.68
All technologies	3,315	22	48	70	0.48

CHP plants can be constructed to use more than one fuel in order to allow flexible reactions to changing fuel prices. Gas turbines require a gaseous fuel, typically natural gas, whereas steam turbines can also operate on coal, oil or waste materials, which are typically cheaper than natural gas.

A few sources provide estimates for investment cost of new CHP technologies (Erdmann and Dittmar 2010, IEA-ETSAP 2010b, Energinet.dk 2012, Matthes and Ziesing 2011, Bremer Energie Institut et al. 2011, US EPA 2015). Based on the available sources, a regression was used to estimate a cost function that explains specific technology costs (Euro per kW<sub>th</sub>) based on the installed capacity of individual technologies (kW). Cost differences between countries were estimated using purchasing power parities for machinery equipment. Table 44 shows exemplary results for the specific costs of four CHP technologies as EU averages (Note that specific costs are related to the installed thermal capacity). Results for all countries are provided in the data annex.

Table 44: Calculated average EU28 specific investment costs for industrial CHP technologies by installed capacity [Euro/kW<sub>th</sub>]

CHP-Technology	<25 kW <sub>th</sub>	25 - 50 kW <sub>th</sub>	51 - 250 kW <sub>th</sub>	251 - 1000 kW <sub>th</sub>	1-5 MW <sub>th</sub>	5 - 25 MW <sub>th</sub>	>25 MW <sub>th</sub>
Steam turbine	n.a.	n.a.	n.a.	1,539	1,509	1,488	1,468
Gas turbine	n.a.	n.a.	n.a.	616	513	431	385
Combined cycle	n.a.	n.a.	n.a.	n.a.	n.a.	1,550	1,539
Internal combustion engine	1,078	1,026	924	852	770	n.a.	n.a.

In terms of renewable energy sources (RES) for CHP fueling, biogas or solid biomass are typical choices. Biogas-fired CHP plants typically have smaller capacities, of between 50 kW and a few MW. In smaller units, internal combustion engines are the dominant technology, while for larger units gas turbines are used.

CHP plants fired with solid biomass are larger, with capacities ranging from a few MW to several hundreds of MW. Biomass CHP plants based on steam turbines can be considered a mature technology, while combined cycle CHP plants with integrated gasification of biomass are only just entering the market (IEA ETSAP 2010a).

Co-firing of biomass in fossil fuel fired CHP plants can be a cheap option in the short- and medium term. Co-firing is already frequently used. The co-firing of biomass in coal fired CHP units is a particularly cheap way to increase the use of RES without large investments (IEA-ETSAP, IRENA 2013). In this case, biomass is fed, together with coal, into the boiler of a steam turbine. The IEA estimates that this costs several hundred Euros per kW installed electrical capacity, which is low compared to investments in new biomass-fired CHP plants (IEA-ETSAP, IRENA 2013). However, co-firing rates are often below 5%, although they can technically reach 20% or more.

### 3.2.3 Technology stock distribution

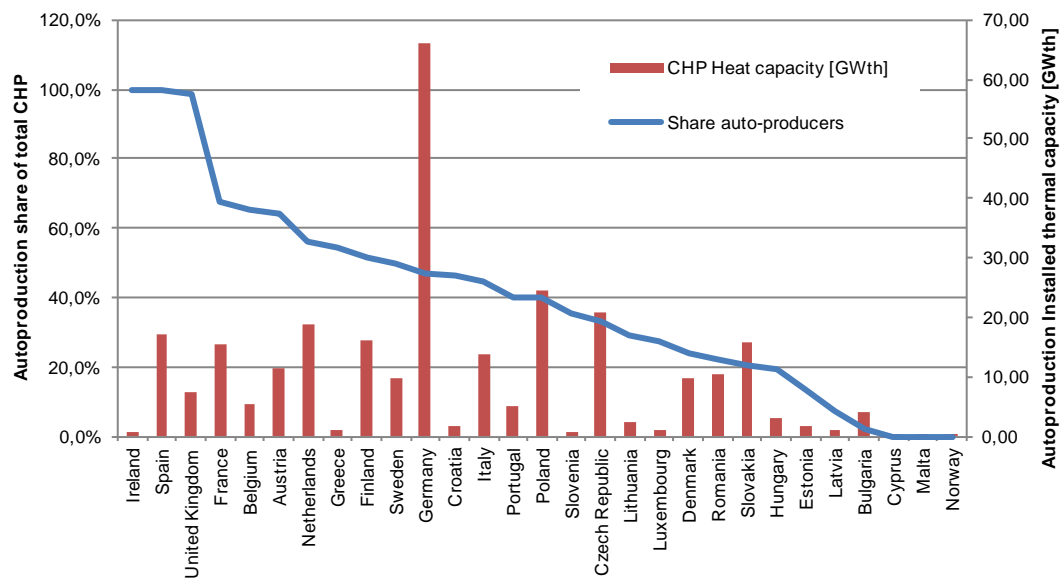
There is currently no EU-wide source available that provides a detailed picture on the stock of CHP technologies used to provide heat in industrial processes. The PLATTS database theoretically provides this information. PLATTS is a commercial database containing information on global electricity producing plants and includes data on, size, construction year, and capacity of the individual plants. However, analyses have shown that the allocation of CHP units to either the manufacturing industry or utilities, which mainly use CHP to feed district heating networks, is not reliable. Comparison to Eurostat statistics shows that the share of CHP plants used for industrial auto-generation is substantially underestimated in the PLATTS database. However, as the PLATTS database is still the most detailed source of information on the stock of CHP units in Europe, we will analyse the database in a combined chapter on large-scale CHP in industry and district heating (chapter 4.2).

In the following, a brief overview on industrial CHP is given, mainly based on Eurostat statistics (Eurostat 2015d) and a few national statistics, where available (focus United Kingdom).

Figure 27 provides an overview of the total CHP auto-production in Europe by country. While auto-production can formally be used in every economic sector, the large share of it comes from industry. This is particularly true when looking at the installed capac-

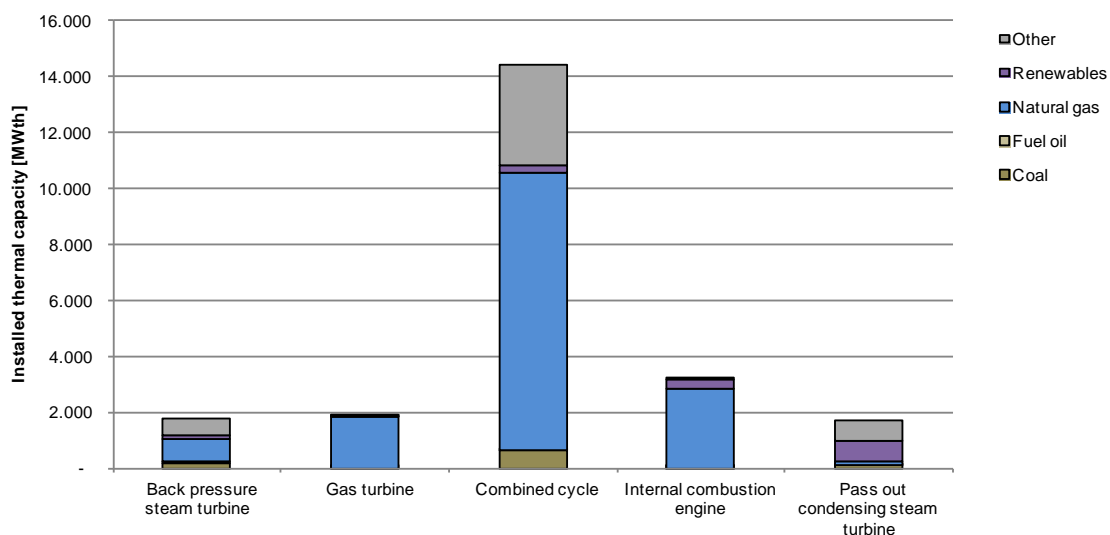
ity. The figure shows auto-generation as share of total CHP thermal capacity by country. It can be seen that in Ireland, Spain and the United Kingdom nearly the complete capacity is used for auto-production.

Figure 27: CHP auto-production by country in 2012 (source: Eurostat 2015d)



While Eurostat does not provide information on the types of technologies, such statistics are for example available for the UK. At the same time, the UK's CHP capacity is totally dominated by auto-generation. 80% of all CHP thermal capacity is installed in the industry sector. Thus, technology shares for the total UK CHP stock also provide a good picture for industrial CHP applications in the UK. In total the UK industrial sector comprises 384 CHP units. As illustrated in Figure 28, the dominant technology in the UK is the combined cycle plant with about 64% of the total installed thermal capacity. Internal combustion units also show a substantial share, of which most are not installed in the industrial sector. Natural gas is the dominant fuel with a share of 68%.

Figure 28: CHP thermal capacity by fuel type and technology in the UK in 2013 (source: Department of Energy and Climate Change 2015a)



In Germany for example the technology share in industrial CHP differs completely from the UK. Steam turbines (53%) and gas turbines (44%) accounted for nearly all (electricity) production of industrial CHP in 2007 (Erdmann and Dittmar 2010). The main industrial sectors using CHP in Germany are the chemical industry and the pulp and paper industry.



### **3.3 Furnaces in the iron and steel industry**

#### **3.3.1 Scope and description of technology**

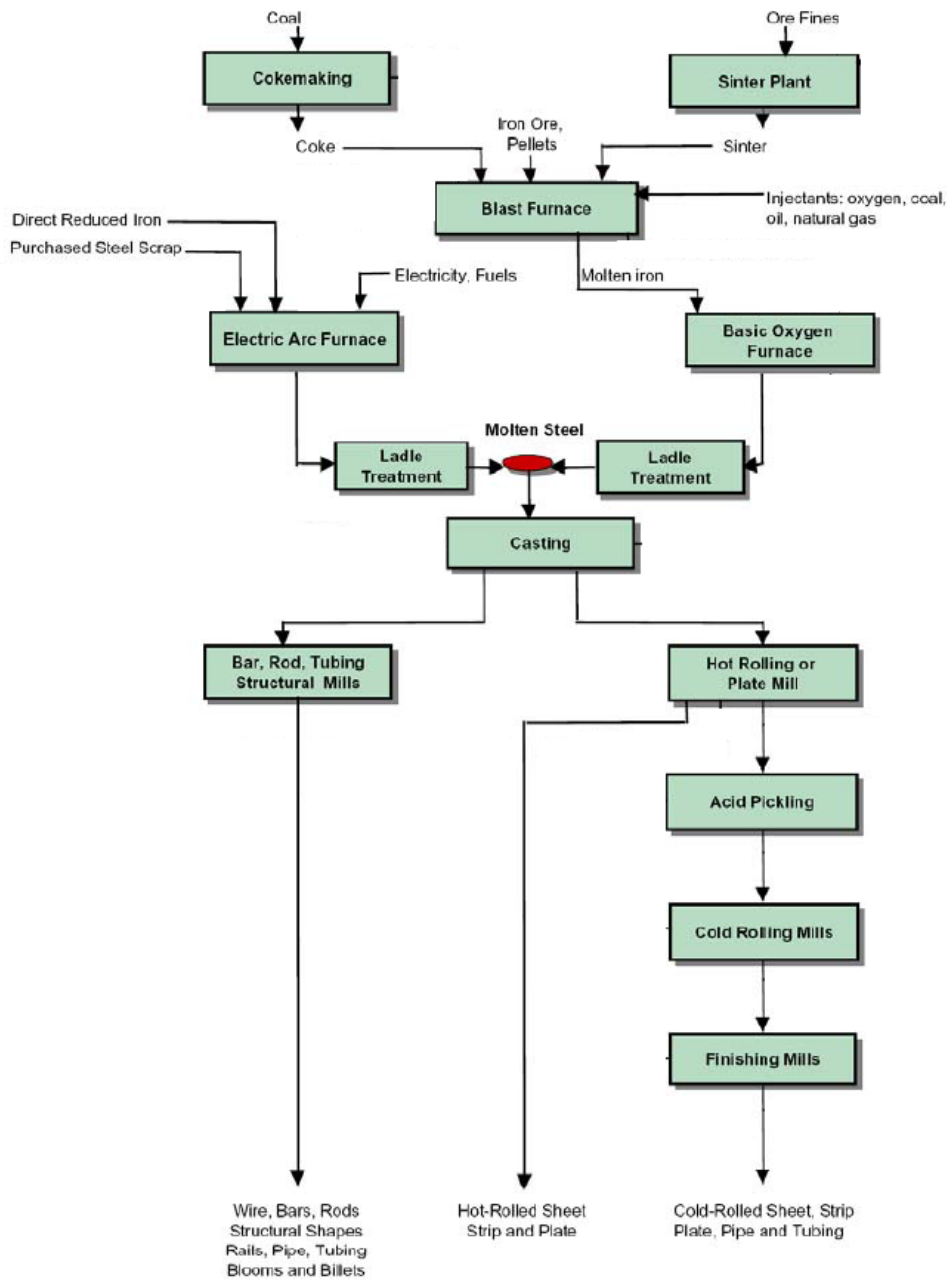
In Europe, there are two main routes for steel production: primary production based on iron ore and secondary production based on scrap (Figure 29). The production routes are split into several different processes: coking plants, sinter/pellet plants, blast furnaces for primary steelmaking and electric arc furnaces (EAFs) for secondary steelmaking, with shared downstream processes (semi-finished products, secondary metallurgy and finished products).

In 2012, around 60% of steel products in the EU27<sup>5</sup> were based on primary steelmaking (Worldsteel Committee on Economic Studies (2013)). In this route the raw material iron ore is reduced to hot metal in the blast furnace. The first input into the blast furnace is sinter i.e. agglomerated iron ore and the second is coke i.e. porous material based on coal. Hot metal is converted to liquid steel in the basic oxygen furnace (BOF), where steel scrap is added. The high specific net energy consumption in the blast furnace of approximately 12 GJ/t hot metal (17 to 18 GJ/t including auxiliary processes (VDEh2015), generating temperatures of up to 2200°C, makes the blast furnace the most energy intensive process within the iron and steel sector. A by-product of the blast furnace is blast furnace gas (top gas) that is used within the steel sector for the heating of hot stoves, in reheating furnaces in the process of rolling or to be fed to onsite power plants for the production of electricity.

---

<sup>5</sup> The source is based on data from 2012. As such, Croatia is not included in these figures as it joined in 2013. Together with the three non-EU members in scope (Switzerland, Iceland and Norway), it is included in the analysis starting in 3.3.3, where differences between countries become relevant. They are referred to as EU-28+3

Figure 29: Steel production routes.



Source: Worrell et al. 2010, edited

The other main production route is secondary steelmaking that recycles scrap in electric arc furnaces (EAF). This method contributes a market share of about 40% in Europe (2012) (Worldsteel Committee on Economic Studies (2013)). Besides scrap, direct reduced iron (DRI) can also be fed to EAFs. Scrap and DRI are melted using an electric discharge, reaching temperatures of up to 3500°C. Secondary metallurgy processes, such as ladle furnaces or vacuum treatment, may be applied to further refine the product and meet special needs. While the specific final energy consumption, with about 3 GJ/t steel, is lower than the consumption in the blast furnace route, the primary energy demand depends on the generation of the required electricity.

Model results show that energy consumption in processes prior to steelmaking accounts for approximately 75% of energy demand in the iron and steel sector with the rest being divided among the various downstream activities (rolling, refinement etc.).

Alternative iron production technologies that mitigate coke use in favour of coal (smelting reduction) or natural gas (direct reduction) are not relevant in the EU so far.

### 3.3.2 Technology characterisation

#### Blast Furnaces

Blast furnaces use coke and coal as reducing agents, with the addition of natural gas as a source of energy (Worrell et al. 2010).<sup>6</sup> Waste plastics and charcoal (“bio-coke”) can reduce the CO<sub>2</sub> emissions of blast furnaces (Suopajarvi 2013) while the injection of pulverised coal (PCI) is applied to reduce coke demand. However, a certain consumption of coke has to be assured since it sustains the permeability of the blast furnace.

Since the 1950s the total reducing agent rate required has decreased from roughly 1000 to 500 kg/thm (Stahlinstitut VDEh (2013))<sup>7</sup>. However, this has progressed little since the 1980s (Dahlmann, et al. 2010).

In Germany, net energy consumption in blast furnaces was 12.2 GJ/thm in 2010<sup>8</sup>, which is equivalent to the energy content of about 429 kg of coke<sup>9</sup> (assuming 28.43 MJ/kg (Arens et al. 2012)). Credits for top gas production have been assigned amounting to about 5.1 GJ/thm<sup>10</sup>. Using best available technologies, net energy consumption could be reduced to 11.6 - 12.3 GJ/thm (Worrell et al. 2010; Moya, Pardo 2013). Hence, further energy reduction potential is limited.

According to Schott et al. (2012), chemical processes inside the blast furnace consume around 9 GJ/thm. This study also gives credits for top gas production of 5.1 GJ/thm. If this top gas could be completely used within the blast furnace, the remaining fuel demand would be the energy required for the chemical processes (9 GJ/thm), heat in the metal (1.3 GJ/thm), heat in the slag (0.44 GJ/thm) and energy losses at the blast furnaces walls (0.55 GJ/thm) (Schott et al. 2012), summing up to 11.3 GJ/thm.

Given these figures, the overall thermal efficiency of the state of the art blast furnace is about 63%. This value is calculated using internal processes in the blast furnace and

---

6 However, the use of natural gas is not economically feasible in the EU today.

7 Widely allocated to the use of oversea high grade ore.

8 Brunke, Blesl 2014. All of this is in line with worldwide developments, e.g. Yoshiyuki et al. 2005.

9 Of which around 80% is actual coke use, the rest pulverized coal and oil Dahlmann et al. 2010.

10 Top gas is a byproduct of blast furnace operations. It consists mainly of carbon monoxide as such has energetic value. It is often used in on-site power plants or fed back into the blast furnace. “Assigning credits” in this context means, that top gas leaving the blast furnace and being used elsewhere is considered to lower the overall energy demand, yielding a net demand. If one assumes that the top gas can not be used elsewhere (e.g. in case power generation relies completely on renewable sources) this credit may not be given.

the heat in the hot metal as benefits and the injected final energy (16.4 GJ/thm) as effort, based on the values of Schott et al. (2012). In the case of internal top gas use, the energy content of the top gas is subtracted from the effort to achieve a theoretical efficiency, deliberately neglecting losses in the recirculation. This generates an efficiency of 91%. Since the top gas is nowadays used downstream, it would have to be replaced in case of internal use. This may be done with natural gas or, in case of electricity generation, renewable energy sources.

Dahlmann et al. (2010) find a 25% reduction in the use of carbon (coke and coal) if blast furnace gas is used internally. This yields a similar result. It must be noted however, that the development of the top gas recycling blast furnace has come to a halt.

European steel industry has overcapacities and blast furnace capacity is currently not extended. Hence reliable, up to date economic data on the investment of blast furnaces are scarce. The last newly built blast furnace within the EU-28+3 was blast furnace No. 8 of ThyssenKrupp Steel Europe in Duisburg in 2007. Specific capital costs were about 125 €/thm (ThyssenKrupp Steel Europe 2007). In India a steel plant was planned (though not realised) with projected capital costs of between 410 and 516 €/t crude steel (including auxiliaries) (Odisha Posco 2005). BCG (2013) finds specific capital costs for blast furnaces to be about 150<sup>11</sup> €/t crude steel (cs) and about 293 €/tcs for auxiliaries. This amounts to 443 €/tcs. The figures regarding specific investment costs / capital costs have been adapted to achieve purchase power parity as it is indexed by Eurostat (2014).

### **Coking plants**

Coking plants produce coke out of high-grade hard coal by pyrolysis. This thermochemical process removes volatile substances from the coal; the remaining carbon is permeable to the gas flow in the blast furnace, yet stable. The main energetic input is coal supplemented by natural gas and rejected coke (internal circulation). The final energy demand of the best available technology is reported to be 3.2 GJ/t coke with some potential for efficiency improvements (coke dry quenching), allowing for an energy consumption of about 2.5 GJ/t (Worrell et al. 2010). BCG (2013) gives details of investments for coking related to the production of crude steel. Coking plants are reported to have a CAPEX of 114 €/tcs.

### **Sinter/ Pellet plants**

Sinter and pellet plants produce agglomerated iron ore that can be fed into the blast furnace. They are baked at more than 1000°C and achieve a homogeneous structure that eases blast furnace operations. The main energy carrier is coke breeze (Arens et al. 2012), while hard coal, natural gas and top gas may also be used. Specific energy consumption is assumed to be 1.8 GJ/t sinter. Energy saving options are heat recovery, use of waste fuels and improved charging (Worrell et al. 2010).

Investments in sinter/pellet plants are related to the production of crude steel. Sinter/pellet plants are reported to have a CAPEX of 51 €/tcs (BCG 2013).

---

11 Regarding the frame of reference, the differences between one tonne of hot metal and one tonne of crude steel are negligible. NLMK (2012) shows similar figures (165 €/thm).

### Electric Arc Furnaces

Electric arc furnaces typically recycle steel scrap to steel. Hence they omit the energy intensive step of iron making from iron ore. The specific final energy consumption of electric arc furnaces is only about 30% of that of primary steelmaking. The overall primary energy intensity however, depends on the electricity generation. To produce high-quality steel in electric arc furnaces, either high quality scrap has to be used or DRI (or hot metal from blast furnaces) has to be added. Specific energy consumption depends on the input material as well as the technology used. Worrell et al. (2010) report a mean consumption of around 2 GJ/tcs with a broad range from 1.3 to 2.7 GJ/tcs. Saving options include scrap preheating, heat recovery and the injection of high-grade waste. The thermal efficiency can be estimated to be 50-70% with possible improvements of up to 80%<sup>12</sup>.

The OECD expects no increase in EAF capacity in the EU (OECD, 2015). The capital costs are often compared to those of the blast furnace route and assumed to be two to three times lower (Compton 2001, Steelonthenet 2015, Crandall 1996). Based on this, we assume capital costs to be around 165 €/tcs<sup>13</sup>. BCG (2013) assumes 184 €/tcs.

### Steelmaking and secondary metallurgy

This category represents the basic oxygen (BOF) furnace that produces steel from hot metal and further treatment of the steel (e.g. alloying, remelting, degassing) to achieve homogenous chemical composition (Worrell et al. 2010) and special properties. The energy consumption of these processes depends on logistic and monitoring efforts since repeated reheating of the metal significantly reduces thermal efficiency. In theory, the BOF itself does not consume energy besides the amount needed for oxygen production since the oxidation of the carbon content of the hot metal is exothermal. It could even be a net producer when recovering sensible and latent heat in off-gas and the furnace itself. Unless this is done, a specific consumption of about 0.3 GJ/t can be assumed (Worrell et al. 2010). Investments are reported as 128 €/tcs (BCG 2013).

### Semi-finished Products

For this project, we define semi-finished products as processed materials that have not undergone a special treatment as defined in "Finished products". This category therefore covers casters, wire rod, bar, plate, section mills and others.

Efforts to describe economic and technical properties of this category are difficult because of the strong diversity of both the products and the involved processes and applied technologies. Specific energy consumption for heat generation ranges from 0.2 GJ/t (slab casting) up to 3 GJ/t (hot strip coil) (Wees et al. 1986) in individual processes. The overall energy demand for a specific product therefore depends on the

---

12 We assume a theoretical minimum of 0.75 GJ/thm to melt steel (1500°C, 500 J/kgK), which may vary depending on alloying elements. New EAF reach specific energy consumption (SEC) of 1 GJ/thm, older ones around 1.3 GJ/thm (Siemens 2011). Since these figures depend heavily on the input material, a broad range is expected.

13 This figure is to be understood as capital costs of the production of crude steel, excluding further processing which may happen on site. It therefore needs to be compared with the sum of the costs of blast furnace and its material preparation.

grade of finalisation but may be approximated with 3 GJ/t, accounting for multiple reheating and subsequent process steps. The main energy carrier is natural gas with the supplement of by-product gases if available on site. Technological as well as logistic energy efficiency can have a huge impact on these figures since cooling and subsequent reheating during process steps account for most of the energy demand with a theoretical lower limit of 0.6 GJ/t needed to heat steel from the environment to workable temperatures (above 1000°C for hot rolling).

A newly commissioned cold rolling plant in India (Posco 2015) was reported as having capital costs of 350 €/t rolled steel. Although the degree of finalisation of the product is not completely determined, the intended use in the automobile industry indicates high quality, thus raising the costs to some extent. Capital costs of an integrated steel plant (including blast furnace, auxiliaries and certain stages of further processing in one site) are reported to be around 870 €/tcs (The Indian Express 2015). Thus this report assumes about 300 to 400 €/t capital costs for further processing (semi-finished and finished products) of crude steel.

### **Finished products**

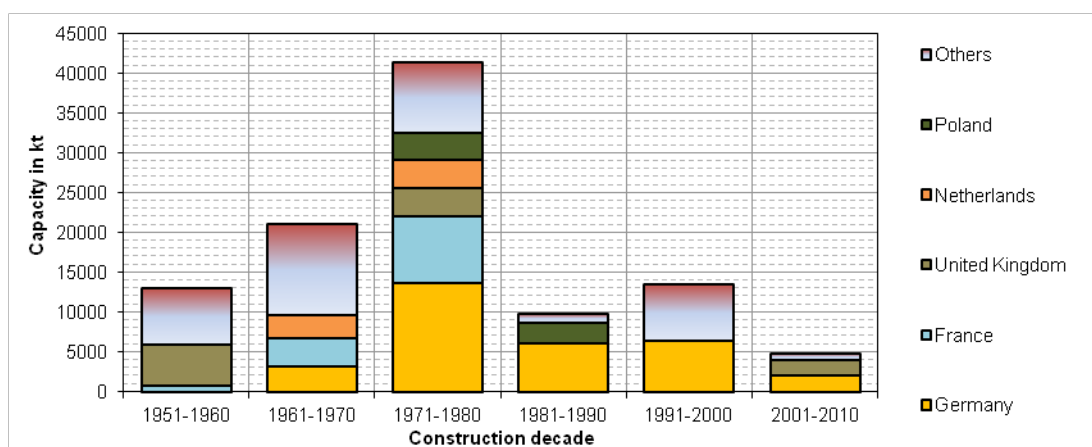
We define finished products as those that undergo special treatment, such as coating, annealing, and pickling. Note that the distinction between finished and semi-finished products is not always possible since annealing and pickling may be single steps in the production of semi-finished products, with additional subsequent rolling or other processes. Rolled products may also be named “finished” products. Energy demand for coating is reported to be 0.5 GJ/t (2kWh/m<sup>2</sup> (ECCA 2012), assuming 10 mm thickness of the coil). EPA (2012) reports energy demands of 0.75 GJ/t for annealing and 1.1 GJ/t for pickling.

### **3.3.3 Technology stock distribution**

#### **Blast Furnaces**

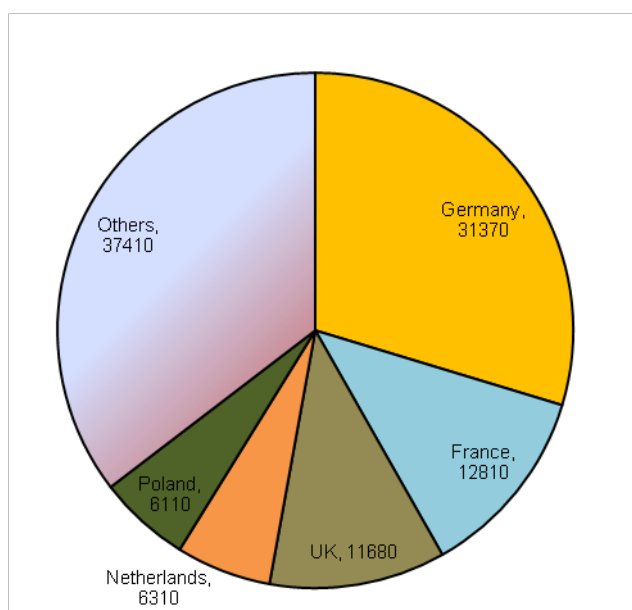
Blast furnace operations exist in about half of the countries within the scope. Germany, France, the United Kingdom and the Netherlands account for 60% of the installed nominal capacity of 106 Mthm/a in 63 plants (Figure 31). Overall capacity utilisation is about 88% (Worldsteel Association 2013). 70% of the total operating blast furnace capacity is older than 35 years (Figure 30). Assuming a normal technical lifetime of about 45 to 50 years, this part of the installed capacity would be at the end of its life cycle in 2025.

Figure 30: Plant capacity age distribution blast furnace in kt.



Source: Stahlinstitut VDEh (2015)

Figure 31: Blast Furnace Capacity by Country in kt in 2012.



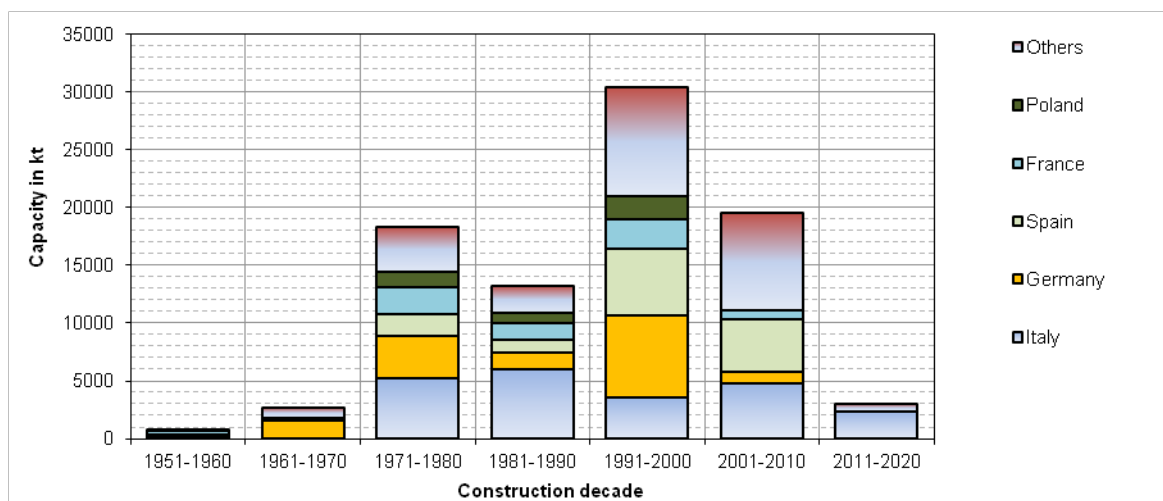
Source: Stahlinstitut VDEh (2015)

### Electric Arc Furnaces

While 15 countries do not use blast furnaces, EAFs are used by 23 of the 31 countries within the scope of the study (Stahlinstitut VDEh2015). Among these are countries that do not engage in blast furnace operations at all such as Luxembourg, Latvia, Portugal and Slovenia.

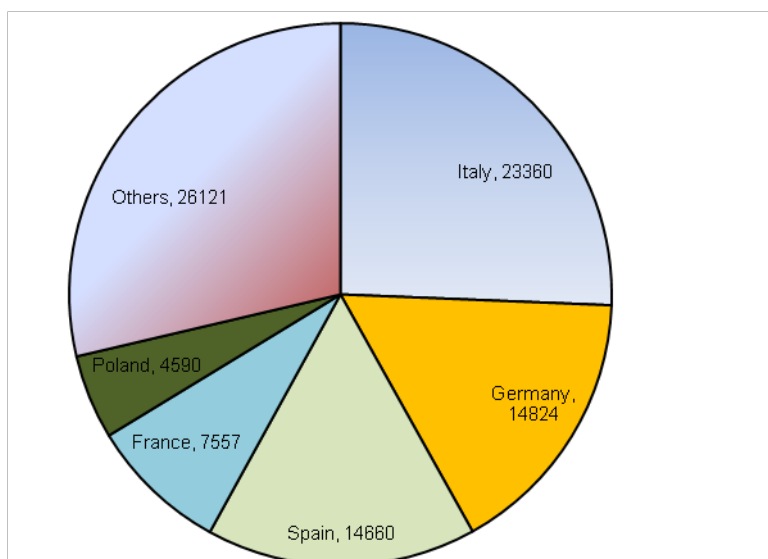
Italy, Spain, Germany and France represent a share of 66% of the total accounted capacity of 91.1 Mthm/a (Figure 33). Similar to blast furnaces, around 60% of EAFs in EU-28+3 will have reached the end of the assumed life span of 25-30 years during the next five to ten years (Figure 32).

Figure 32: Plant capacity age distribution EAF in kt.



Source: Stahlinstitut VDEh (2015)

Figure 33: EAF capacity by country in kt.



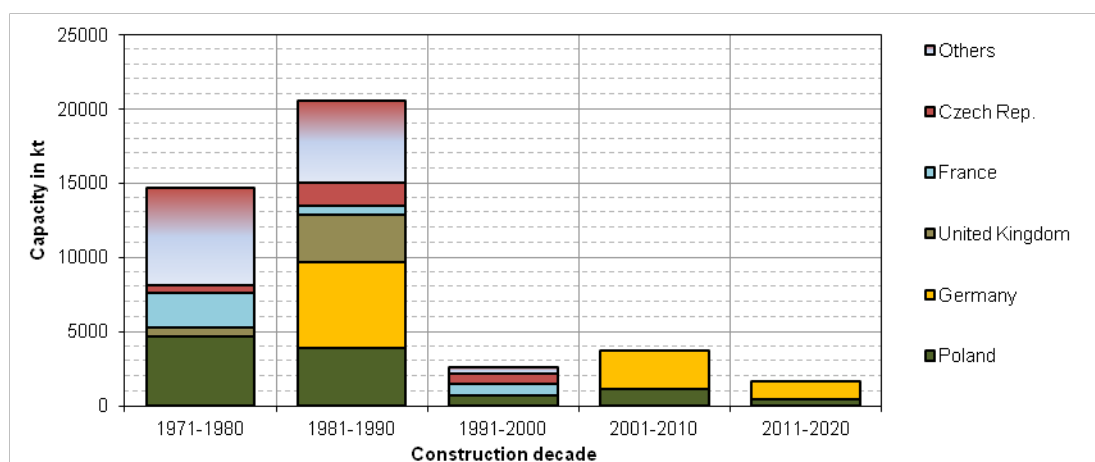
Source: Stahlinstitut VDEh (2015)

### Coking

Coking plants are generally part of integrated steel plants and thus closely related to blast furnace activities. This is reflected in the age distribution of coking plants (Figure 34) which share a similar declining trend from 1980 to date as blast furnaces (Figure 30). However, the distribution of operational capacities by country (Figure 35) shows that large volumes of coke are produced off-site. Germany, for example, imported 27% of its coke demand in 2012 (AGEB 2014). The overall coking capacity (47.6 Mt) is roughly 45% of the blast furnace capacity (105.7 Mt).

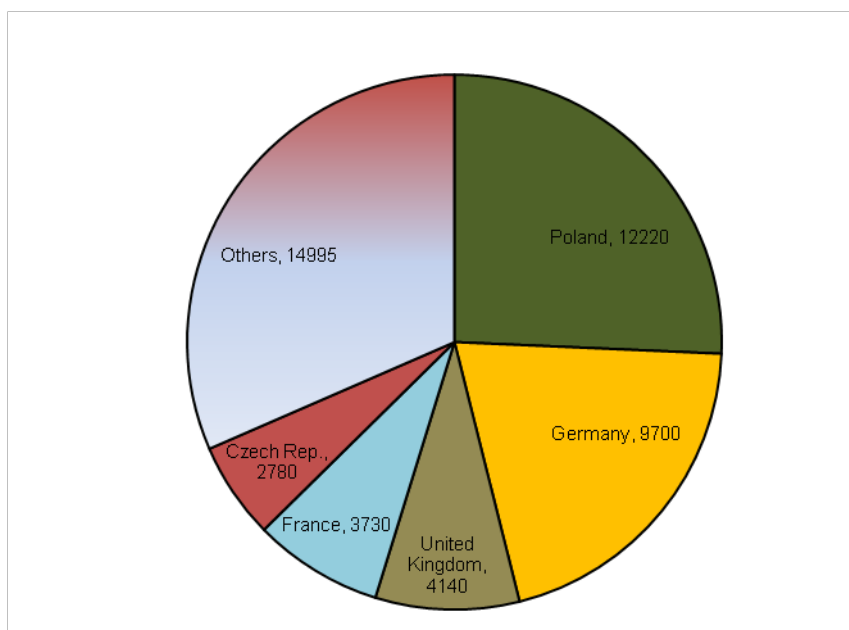


Figure 34: Plant capacity age distribution coking in kt.



Source: Stahlinstitut VDEh (2015)

Figure 35: Coking capacity by country in kt.

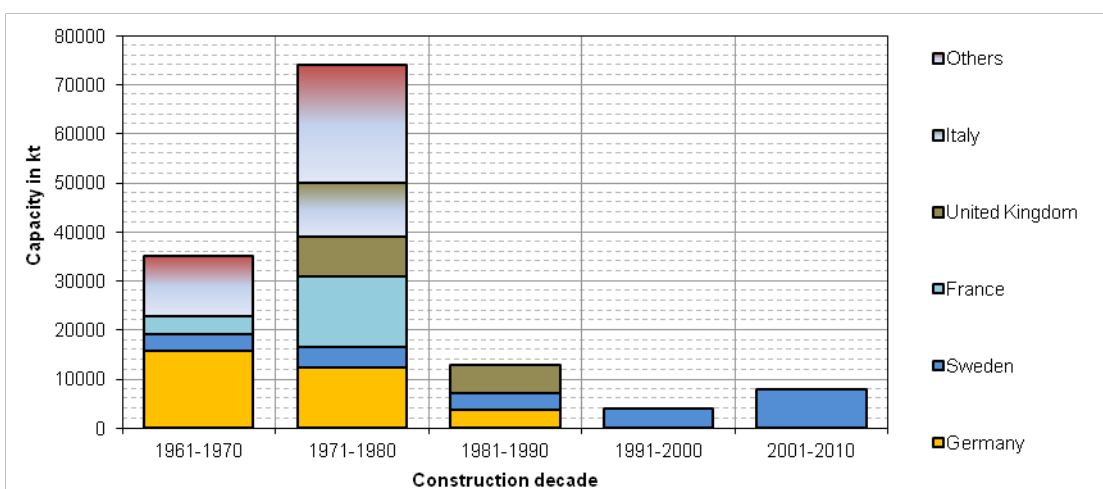


Source: Stahlinstitut VDEh (2015)

### Sinter/ Pellets

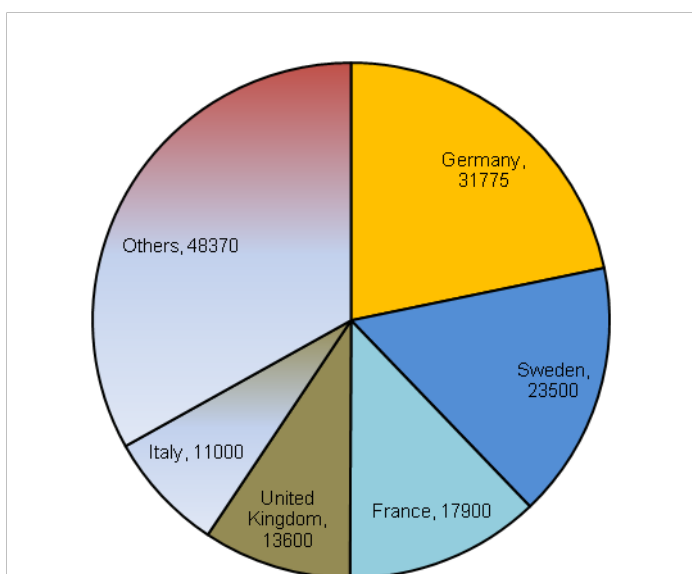
The age distribution of sinter and pellet plants (Figure 36) is similar to that of blast furnaces. Sinter plants represent 80% of this group, since pelletising plants are usually directly located at the mining site (Arens et al. 2012). There is only one pelletising plant in the Netherlands. All other pellet plants are located in Sweden, which is the only iron-ore mining country in the EU-28+3 (Stahlinstitut VDEh 2015). The steel industry in the EU-28+3 purchases about 25% of its iron ore from within the EU-28+3 (37 Mt in 2011 from Sweden, 116 Mt in 2011 from third countries). The main producers of sinter are main primary steel producing countries (Germany, Sweden, France, United Kingdom and Italy) (Figure 37).

Figure 36: Plant capacity age distribution sinter/ pellet in kt.



Source: Stahlinstitut VDEh (2015)

Figure 37: Sinter/ pellet capacity by country in kt.

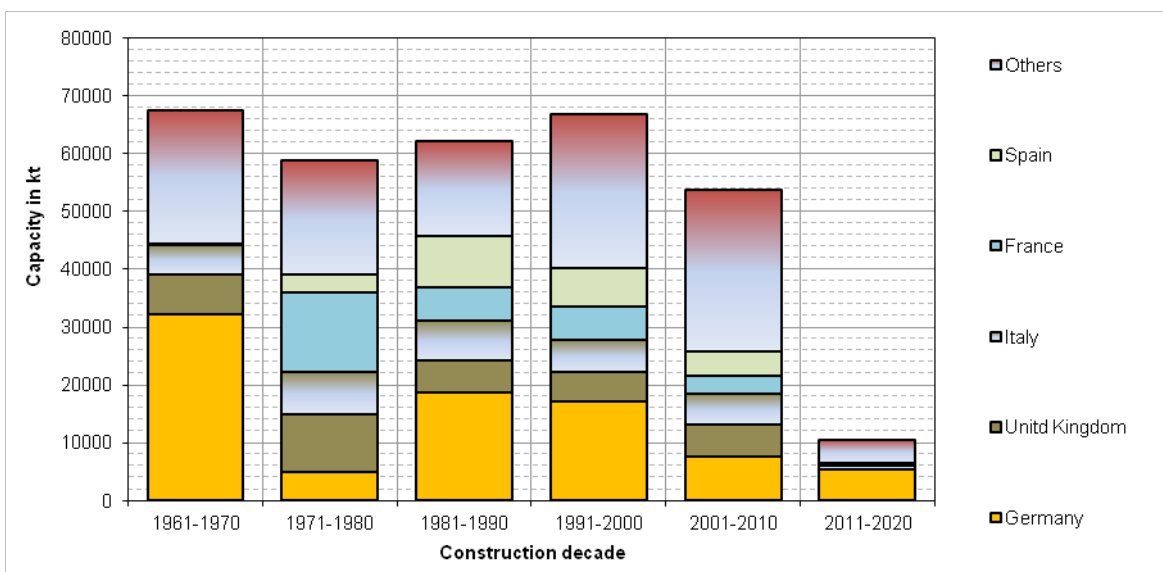


Source: Stahlinstitut VDEh (2015)

### Steelmaking and secondary metallurgy

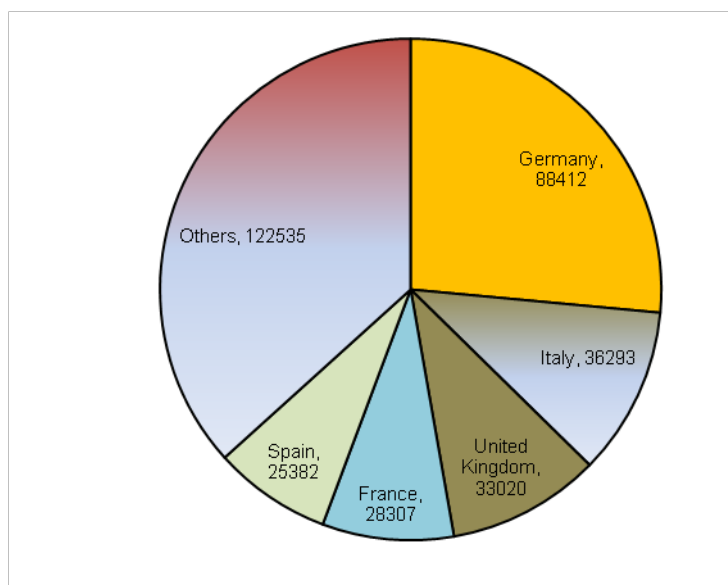
The age distribution of steelmaking and secondary metallurgy plants (Figure 38) is similar to that of the EAF with a considerably higher proportion built after 1970 than blast furnaces. Up until 2010, capacity has been added at an almost constant rate of 60 Mt each decade. The distribution by country (Figure 39) resembles that of blast furnaces and EAF combined (Figure 40) with Germany, Italy, United Kingdom, France and Spain providing 65% of the total capacity, although in a different order.

Figure 38: Plant capacity age distribution steelmaking, secondary metallurgy in kt.



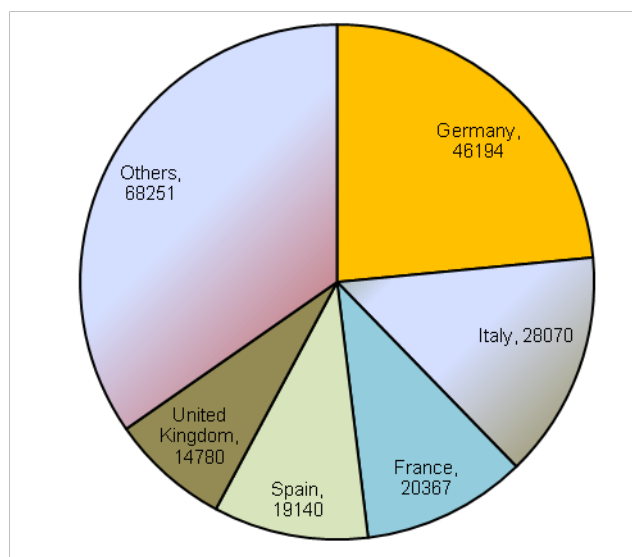
Source: Stahlinstitut VDEh (2015)

Figure 39: Steelmaking and secondary metallurgy capacity by country in kt.



Source: Stahlinstitut VDEh (2015)

Figure 40: EAF + blast furnace capacity by country in kt.

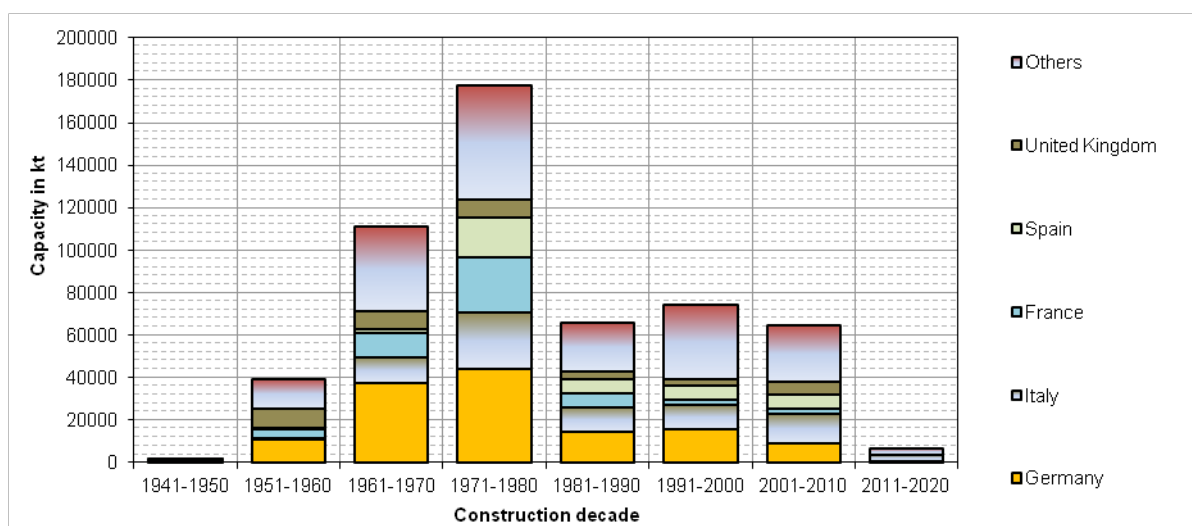


Source: Stahlinstitut VDEh (2015)

### Semi-finished products

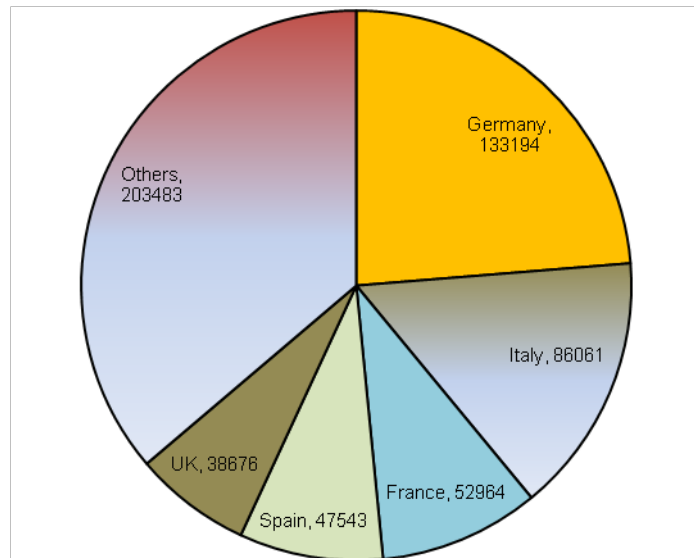
Semi-finished products comprise all casters and mills, including producers of flat (coil, plates) and long products (sections, billets, bars, wire rod, rails etc.). The age distribution (Figure 41) shows a peak in the 1970s followed by strongly declining investments, resembling the development of blast furnaces. The main countries of operation are Germany, Italy, France, Spain and the United Kingdom (Figure 42).

Figure 41: Plant capacity age distribution "Semi-finished products" in kt.



Source: Stahlinstitut VDEh (2015)

Figure 42: Semi-finished product capacity by country in kt.

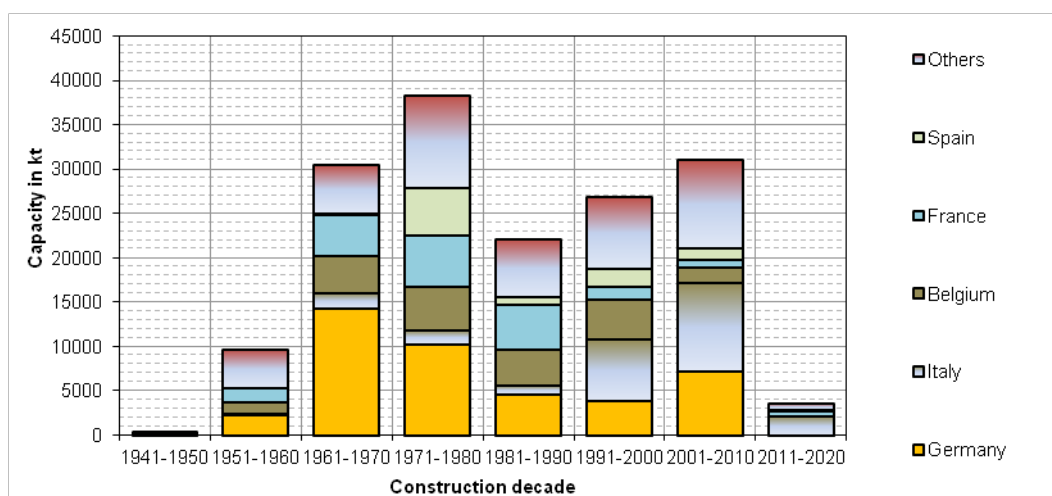


Source: Stahlinstitut VDEh (2015)

### Finished products

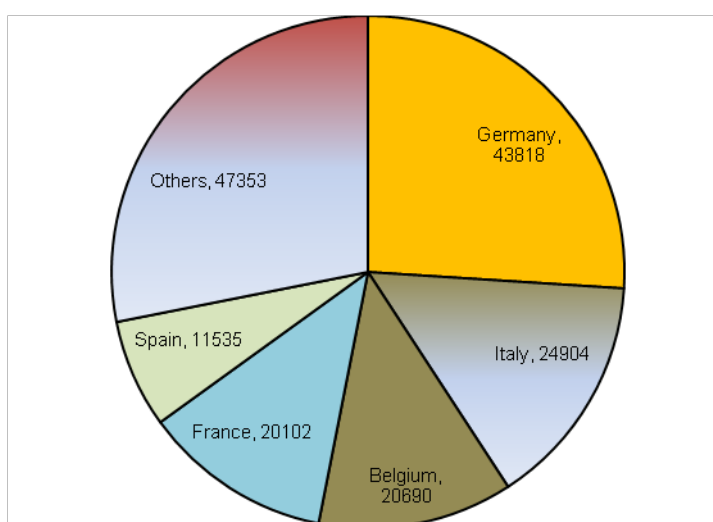
Plant types classified as finished products (annealing, pickling, and coating) show a somewhat different age distribution. While investments around 1970 are strong, they stay at a relative high level during more recent decades, mainly due to increasing activity in Italy (Figure 43). The new build capacity of the other countries (Germany, France, Belgium and Spain) follows the declining trend also visible in blast furnaces. The main countries of operation are Germany, Italy, Belgium, France and Spain (Figure 44).

Figure 43: Finished products plant age distribution in kt.



Source: Stahlinstitut VDEh (2015)

Figure 44: Finished products capacity by country in kt.



Source: Stahlinstitut VDEh (2015)

### 3.4 Furnaces in the cement industry

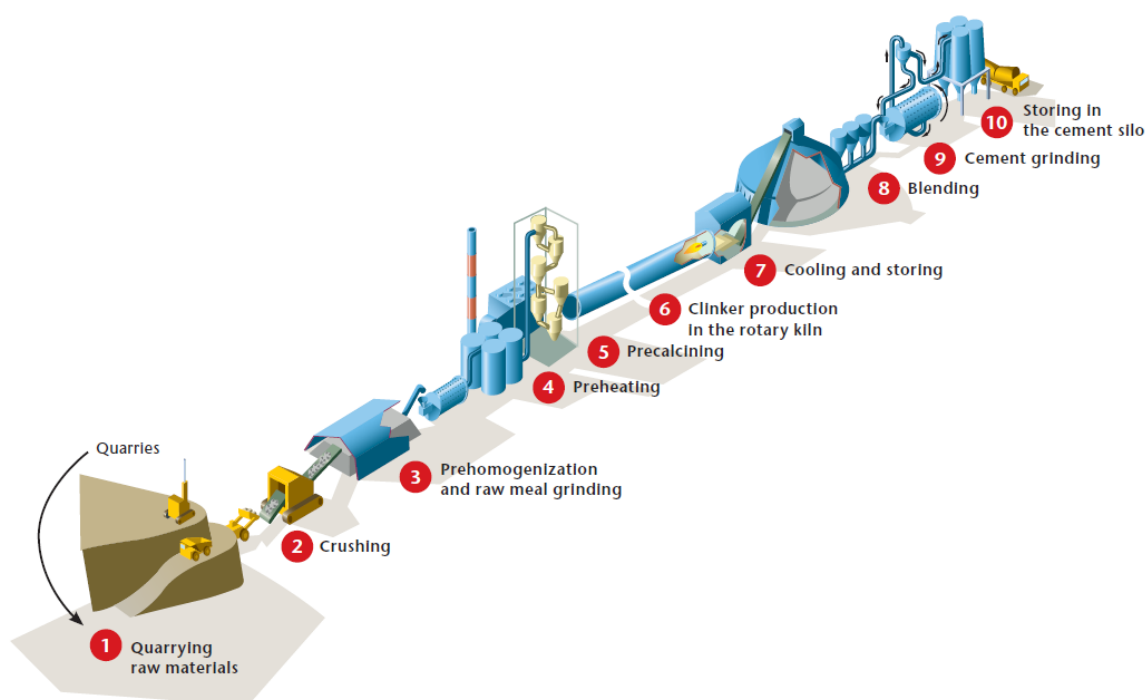
#### 3.4.1 Scope and description of technology

The industry of non-metallic mineral products comprises the cement, ceramics, glass and lime sectors. With regard to energy demand and CO<sub>2</sub> emissions the most relevant process is the manufacturing of cement.

Cement is generally produced from a feedstock of limestone, clay and sand, which provide the four key ingredients required: lime, silica, alumina and iron. Mixing these ingredients and exposing them to intense heat causes chemical reactions that convert the partially molten raw materials into pellets called clinker. After adding gypsum, and possibly other minerals, the mixture is ground to form cement. It is used extensively in buildings, bridges, walls and a multitude of other uses.

The process of cement manufacturing is depicted schematically in Figure 45. The following description of the process is taken from the International Energy Agency and World Business Council for Sustainable Development Global Cement Technology Roadmap (IEA, 2009; WBCSD, 2009a).

Figure 45: Industrial process of cement manufacturing.



Source: IEA, 2009; WBCSD, 2009a

The manufacturing process includes the following steps and technical systems (Cembureau, 2013; IEA, 2009; WBCSD, 2009a):

- **Quarrying raw materials:** Naturally occurring calcareous deposits such as limestone, marl or chalk provide calcium carbonate and are extracted from quarries, often located close to the cement plant.
- **Crushing:** The raw material is quarried and transported to the primary / secondary crushers and broken into 10cm large pieces.
- **Pre-homogenisation and raw meal grinding:** Pre-homogenisation is the process

in which different raw materials are mixed to produce the required chemical composition, and the crushed pieces are then milled together to produce "raw meal".

- **Preheating:** A preheater is a series of vertical cyclones (up to six stages) through which the raw meal is passed, coming into contact with swirling hot kiln exhaust gases moving in the opposite direction. In these cyclones, thermal energy is recovered from the hot flue gases, and the raw meal is preheated before it enters the kiln, so the necessary chemical reactions occur quickly and efficiently.
- **Precalcining:** Calcination is the decomposition of limestone to lime. Part of the reaction takes place in the "precalciner", a combustion chamber at the bottom of the preheater above the kiln, and part of it occurs in the kiln. Here, the chemical decomposition of limestone typically emits 60-65% of total emissions. Fuel combustion generates the rest, 65% of which occur in the precalciner.
- **Clinker production in the rotary kiln:** The precalcined meal then enters the kiln. Fuel is fired directly into the kiln to reach temperatures of up to 1,450°C. As the kiln rotates, about 3-5 times per minute, the material slides and tumbles down through progressively hotter zones towards the flame. The intense heat causes chemical and physical reactions that partially melt the meal into clinker.
- **Cooling and storing:** From the kiln, the hot clinker falls onto a grate cooler where it is cooled by incoming combustion air, thereby minimising energy loss from the system. A typical cement plant will have clinker storage between clinker production and grinding. Clinker is commonly traded.
- **Blending:** Clinker is mixed with other mineral components. All cement types contain around 4-5% gypsum to control the setting time of the product. If significant amounts of slag, fly ash, limestone or other materials are used to replace clinker, the product is called "blended cement".
- **Cement grinding:** The cooled clinker and gypsum mixture is ground into a grey powder, Ordinary Portland Cement, or ground with other mineral components to make blended cement.
- **Storing in the cement silo:** The final product is homogenised and stored in cement silos and dispatched from there to either a packing station (for bagged cement) or to a silo truck.

The most widely used cement type is Portland cement, which contains 95% cement clinker. Other types of cement use a variety of clinker substitutes, including granulated blast-furnace slag, fly ash and natural pozzolana, in blends with Portland cement to reduce specific CO<sub>2</sub> emissions and often cement costs. These clinker substitutes have properties similar to cement and can therefore be added to the feedstock for a kiln, or substituted for clinker in either the cement or concrete mix (CEN, 2000).

### 3.4.2 Technology characterisation

#### Specific thermal energy demand

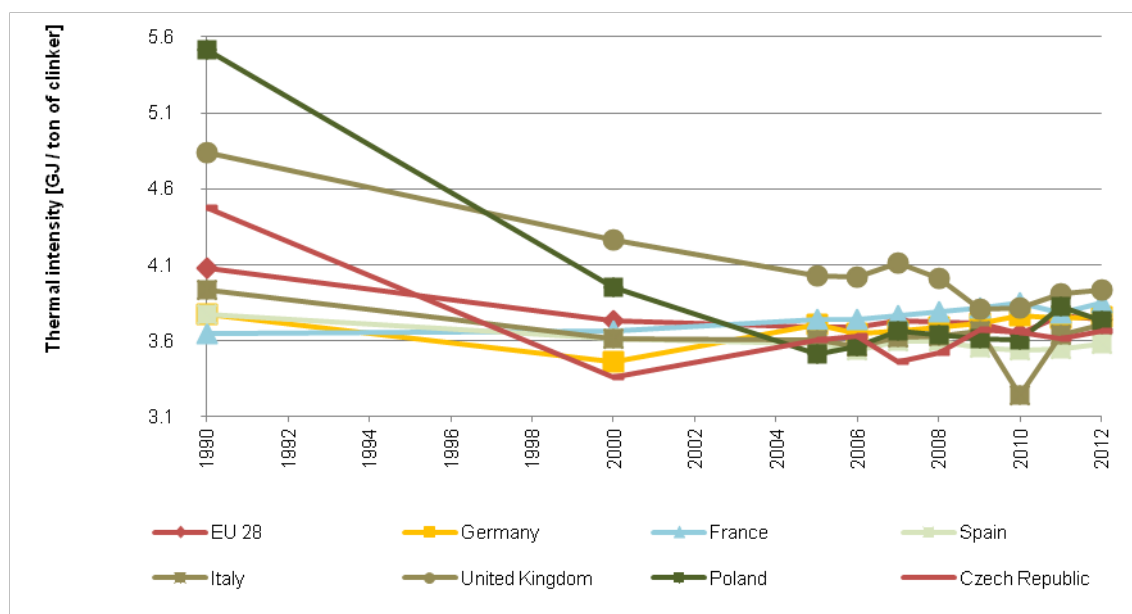
Cement manufacturing requires both thermal energy for heating the clinker kiln and electrical energy (about 10%) mostly for kiln operation, grinding (preparing raw materials) and blending (mixing clinker with additives). In the production of cement, it is the production of clinker from limestone and chalk that consumes most energy.

The most important factors determining the thermal energy demand are the chemical characteristics of the raw materials (moisture content, chemical composition), mineralogical characteristics of raw material (raw material types of the respective storage site, burnability), production capacity of the plant, technical status of the plant, fuel properties, fuel mix and availability (caloric value, reactivity) and the type of kiln operation (CSI and WBCSD, 2009).



Figure 46 shows the thermal energy intensity in GJ per ton of clinker. The thermal energy intensity in the EU 28 decreased from around 4.1 GJ/ton of clinker in 1990 to 3.7 GJ/ton of clinker in 2012 (CEMBUREAU). It then stabilised.

Figure 46: Thermal energy intensity in GJ per ton clinker for the EU 28 and main cement producing countries in Europe.



Sources: Branger and Quirion, 2015; WBCSD, 2009b

There are two basic types of cement production process. These are referred to as either ‘wet’ or ‘dry’, depending on the water content of the raw material feedstock, although some types of cement fall somewhere in between. The wet process allows for easier control of the chemistry and is better when moist raw feedstocks are available, but it consumes more energy to evaporate the 30% plus slurry water before heating the raw materials to the necessary temperature for calcination. The dry process is more efficient, as it avoids the need for water evaporation.

The increasing number of dry-process kilns with pre-heaters and pre-calciners has had a clear impact on energy demand in clinker production. Efficient dry kilns using pre-heaters use approximately 3.3 GJ/t clinker; a wet kiln can use between 5.9 GJ/t and 6.7 GJ/t clinker.

A further major technology difference is between vertical shaft kilns and their more efficient counterparts, rotary kilns. Today’s state-of-the-art dry rotary kilns are more fuel-efficient than older kilns. The superior performance of dry process rotary kilns with pre-calciners and pre-heaters makes them the technology of choice.

Different types of kilns are briefly explained below (László, et al., 2003; Madlool, et al., 2011):

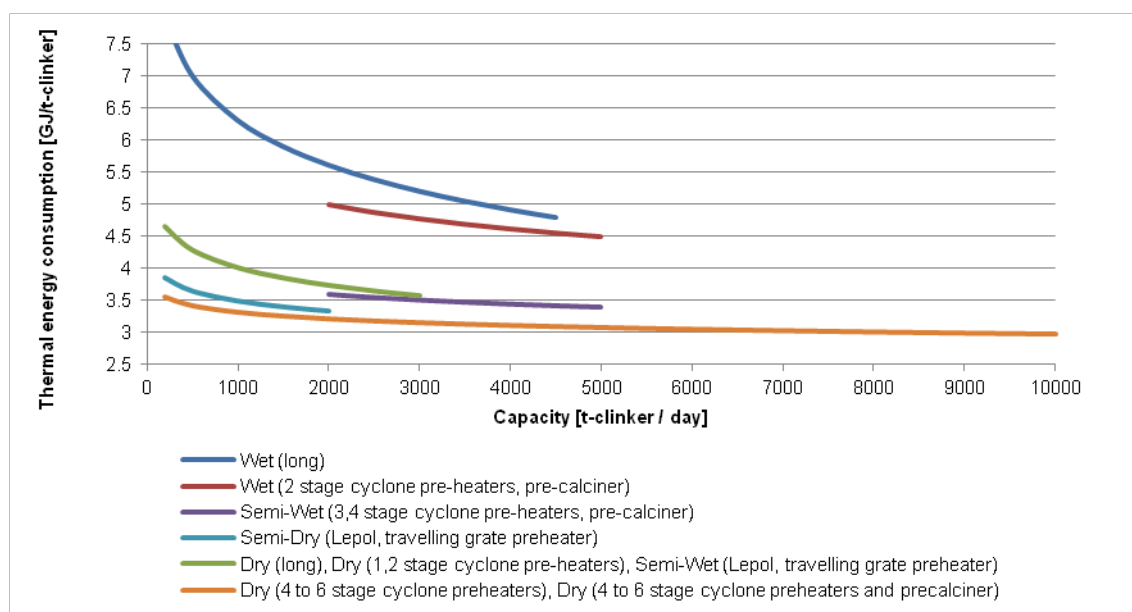
- **Wet rotary kiln:** When the water content of the raw material is within 15–25%, wet slurry is usually produced to feed into the kiln. The wet kiln feed contains about 38% of water and this will make the meal more homogeneous for the kiln, leading to the use of less electrical energy for the grinding. However, overall energy consumption will be higher, to evaporate water in the slurry. This process is still in use in some countries, however many countries are shift-

ing from wet kiln to dry kiln processes to reduce the overall energy consumption.

- Semi-wet rotary kiln: The wet raw material is processed in a filter after homogenising to reduce moisture content. It is an improved version of the wet process and is mainly used for retrofitting the existing wet kilns. This process can reduce energy consumption by 0.3 GJ/tonne of clinker.
- Semi-dry rotary kiln: Waste heat recovered from the kiln is used to remove moisture content and then the dried meal is fed into the kiln. This reduces overall energy consumption to certain extent.
- Dry long kiln: These include long dry kilns without a pre-heater and kilns with a pre-heater, of a shaft or one stage cyclone type. This technology still consumes more energy than new technologies because of the absence of the pre-heater in this type of kiln. Therefore, these technologies are not as efficient as the new multi-cyclone type pre-heaters.
- Dry kilns with pre-heater: This category includes kilns with 4–6 multistage cyclone preheaters. The raw materials are passed through the cyclones and each stage of cyclone has a different range of temperatures. The cyclones are placed above each other in towers and each tower can be more than 100m high. The energy use of kilns with suspension preheaters is much lower than the previous categories. As the calcinations partly take place in the pre-heater, it is possible to reduce the energy consumption by reducing the length of the kiln. However, alkalis may build-up which may cause extra energy use. These alkalis reduce the quality of the cement and can block the operation of the preheated materials resulting in long interruptions in operation.
- Dry kilns with pre-heater and pre-calciner: In this process, an additional combustion chamber is installed between the pre-heater and the kiln. This pre-calciner chamber consumes about 60% of the fuel used in the kiln, and 80–90% of the calcinations take place here. This reduces energy consumption by 8–11%. Low temperature waste heat from the combustion chamber can be recovered for other purposes. Consequently, this will reduce the NO<sub>x</sub> emissions because of the lower burning temperature. The capacity of the kilns could be increased up to 12,000 tonne/day by reducing the length/diameter ratio to 10.

Figure 47 shows the energy intensity of different kiln types.

Figure 47: Thermal energy demand by capacity and type of kiln.



Source: Oda et al., 2012

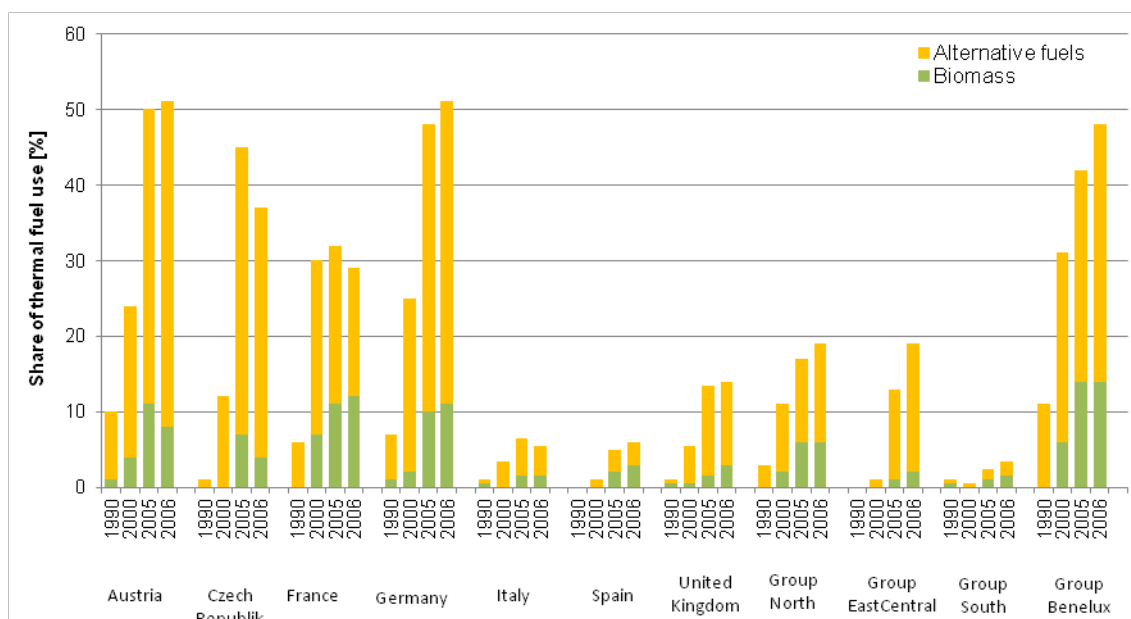
### Alternative fuel use

The use of alternative fuels in the cement industry is a long-established practice in many countries. It offers the opportunity to reduce production costs and fossil fuel use, and to dispose of waste. Where fossil fuels are replaced with alternative fuels such as waste products that would otherwise have been incinerated or land filled, CO<sub>2</sub> emissions can be reduced. Cement kilns are well suited for waste combustion because of their high process temperature and because the clinker product and limestone feed-stock act as gas cleaning agents. Used tyres, wood, plastics, chemicals, treated municipal solid waste and other types of waste are co-combusted in cement kilns in large quantities (IEA, 2009).

European cement manufacturers derived 3% of their energy needs from waste fuels in 1990 and 15% in 2005. Cement producers in Austria, the Czech Republic, France, Germany, Belgium and the Netherlands have reached substitution rates of between, 7% and more than 43% of the total energy used in this time horizon. Some individual plants have achieved nearly 100% substitution using alternative fuels. Where alternative fuels are used at high substitution rates, tailored pre-treatment and surveillance systems are needed. In Europe, the burning of alternative fuels in cement kilns is covered by Directive 2000/76/EC of the European Parliament and Council (IEA, 2009).

An overview of alternative fuel use in clinker production in Europe is depicted in Figure 48.

Figure 48: Alternative fuel use in clinker production in Europe, 1990 to 2006 (percentage of total thermal fuel use).



Source: IEA, 2009; Oda et al., 2012

Notes: Some countries have been grouped together. Group One: Denmark, Finland, Sweden, Norway, Ireland. Group Two: Estonia, Latvia, Poland, Hungary. Group Three: Portugal, Greece, Romania, Slovakia, Bulgaria. Group Four: Belgium, Luxembourg, the Netherlands

### Specific electricity demand

The electricity demand in the cement production process accounts for about 10% of the total energy needed, mostly for kiln operation, grinding and blending. The proportion of total electrical energy used for these steps is respectively 25%, 33% and 30% according to (Schneider et al., 2011). The electrical intensity in the EU 28, after decreasing from 114 kWh/ton of cement in 1990 to 108 kWh/ton of cement in 2006, increased to 116 kWh/ton of cement in 2012. The most noticeable change is in Spain where average electricity intensity soared from 98 kWh/ton of cement in 2006 to 150 kWh/ton of cement in 2012, probably due to the decrease in production which led to the use of machinery operating well below nominal capacity.

### Best available technology and technical saving potential

Current best available technology (BAT) for the cement industry is a dry-process kiln with pre-heater and precalciner. Up to six stages of pre-heating can be applied if the raw material feed has a low moisture content (<6%), although a five-stage pre-heater is the norm in Europe for new plants (IEA, 2009).

The thermodynamic minimum energy required to drive the endothermic reactions is approximately 1.8 GJ/t clinker for dry limestone feedstock. In practice, it is much higher, as feedstocks contain significant moisture (IEA, 2009). The practical BAT level of thermal energy demand of a six-stage pre-heater and pre-calciner kiln is estimated to be in the range of 3.0 GJ/t in the case of six cyclone stages (CSI and WBCSD, 2009; European Commission, 2010). A study carried out by the Research Institute of the Cement Industry in Germany, in the context of the European BAT process, has determined the ranges for the yearly average fuel energy requirement of state of the art cement kilns based on empirical data (VDZ, 2012). These data take all criteria and

impacts into account:

- Three cyclone stages: 3.4-3.8 GJ/t clinker
- Four cyclone stages: 3.2-3.6 GJ/t clinker
- Five cyclone stages: 3.1-3.5 GJ/t clinker
- Six cyclone stages: 3.0-3.4 GJ/t clinker

BAT for electricity consumption in the cement industry depends on the type of plant, but is in the range of 95 kWh/t to 100 kWh/t cement. The increased use of alternative fuels, however, tends to increase electricity demand for pre-treatment and handling (IEA, 2009).

An overview of selected energy saving options is shown in Table 45 added by the associated investment and operational costs in case of a retrofit.

Table 45: Thermal and electric impact of energy saving options added by the associated investment and operational costs in case of a retrofit.

Energy saving options	Thermal impact [MJ/t cli]	Electric impact [kWh/t cli]	Retrofit	
			Investment [Mio €]	Operational [€/t cli]
Improve raw mix burnability	- (50-180)	0-1	-	-(0.06-0.43)
Change from long kilns to preheater/precalciner kilns	-(900-2800)	-(0-5)	70-100	-(2.85-9.2)
Preheater modification	-	-(0.6-1.5)	8-10	-(0.05-0.08)
Efficient clinker cooler technology	-(100-300)	1-6	1-3 or 15-20 <sup>1</sup>	-(0-0.5)
Waste heat recovery	-	8-22 <sup>2</sup>	15-25	-(0.3-1.2)
Additional preheater cyclone stage	-(80-100)	-	5-8	-(0.23-0.26)
Oxygen enrichment technology	-(100-200)	10-35	5-10	0.5-2.3
Upgrade plant automation/control package	-(50-200)	-(0-1)	0.25-0.35	-(0.27-0.74)
Alternative decarbonated raw materials for clinker production	-(100-400)	0-2	0-6	0-4.2
Alternative fuels, replacing conventional fossil fuels	0-300	0-3	5-15	-(2-8)
Fuel switch (coal/petcoke->oil/gas/pure biomass)	300 - (-200)	0-3	5-15	8-16*
Increase of the kiln capacity	-(150-200)	-(2-4)	-	-
Retrofit mono-channel burner to modern multi-channel burner	-(25-75)	-	0.4-0.5	-(0.08-0.25)
Fluidized bed advanced cement kiln system	-(0-300)	9	-	-(0-0.3)
Cement grinding with vertical roller mills and roller presses	-	-(12-16)**	-	-
High efficiency separators	-	-4	2,5	-0,28
Optimization of operating parameters of ball mills	-	-(0-2)**	0,01	-(0-0.15)***
Variable speed drives	-	-(3-9)**	0.25-0.35	-(0.3-0.7)***
* [€/t cli or cem]				
** [kWh/t cem]				
*** [€/t cem]				
<sup>1</sup> Complete replacement				
<sup>2</sup> Absolute power consumption of clinker production will slightly increase, but net power consumption will decrease				

Source: CSI and WBCSD, 2009

The cement manufacturing is highly capital intensive, and the lifetime of cement kilns is usually 30 to 50 years. New kilns are predominantly built in places where market growth is high, e.g. in Eastern Europe, but the technical equipment of cement kilns is being continuously modernised. This means that most of the original equipment is often replaced after 20 or 30 years (e.g. preheater cyclones, clinker cooler, burner, etc.) and is always adapted to modern technology. This can be seen for example in European data, where kilns are relatively old, but nevertheless efficient (Brunke and Blesl, 2014; CSI and WBCSD, 2009; Wen et al., 2015).

Only huge retrofits, like changing from wet to dry processes, result in a significant increasing in energy efficiency. Investment similar to that of new kilns is required for this kind of retrofit and they will only be carried out if the market situation is very

promoting or the equipment is very old. However this kind of extensive retrofit often enables the efficiency gap with state of the art technology to be closed. On the other hand compromises, such as kiln downtime, are often necessary with retrofits (Brunke and Blesl, 2014; CSI and WBCSD, 2009).

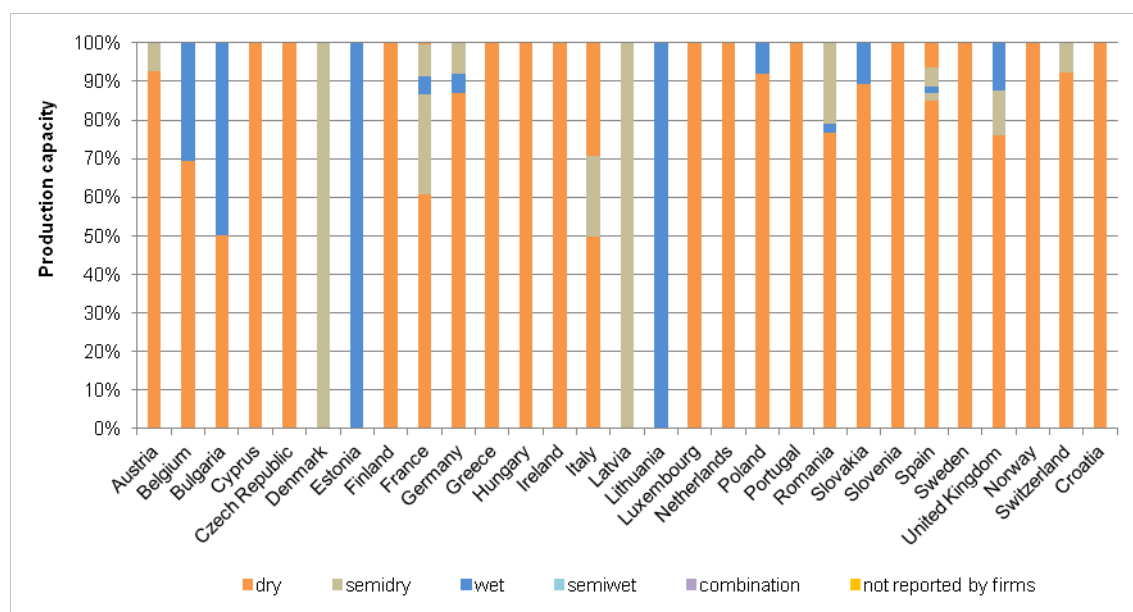
### 3.4.3 Technology stock distribution

#### Type of kiln

The thermal energy demand of the cement industry is strongly linked to the type of kiln used. The more efficient dry process with pre-heaters and pre-calciners is the technology of choice for new plants as shown by trends in the stock of plants in operation. Since 1990, dry technologies have exhibited a marked increase in all the regions for which data are available. However, at a country level, the share of the more energy-efficient dry process varies significantly, by between 12% and 100% (IEA, 2007; IEA, 2009).

The Global Cement Directory provides production capacity data on an annual basis by country. These data are further distinguished by sites on a global level. Figure 49 depicts the share of different kiln types based on the production capacity in 2012 in EU 28 countries.

Figure 49: Type of kiln installed in 2012 based on production capacity.



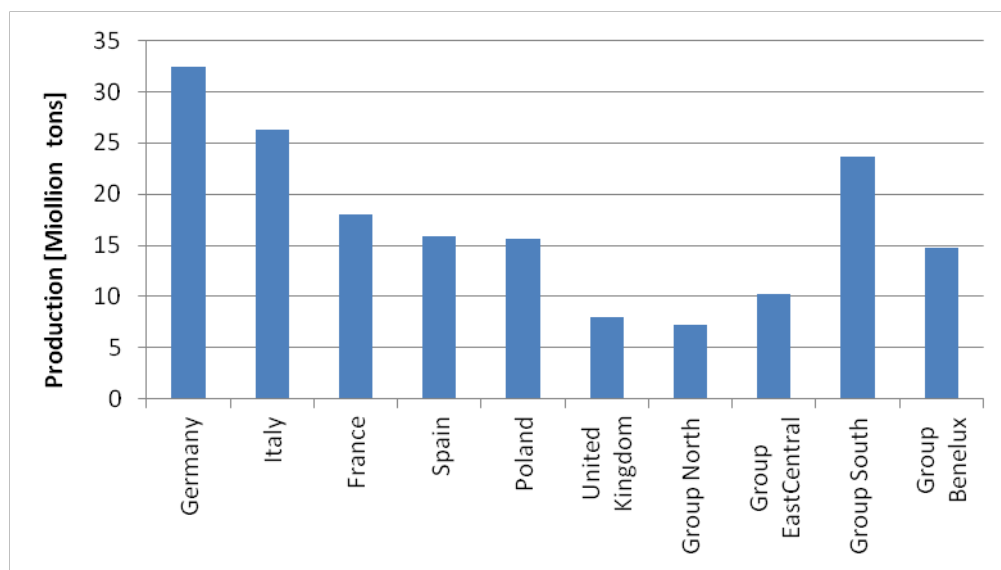
Source: Klee et al., 2011; Lasselle, 2013; McCaffrey et al., 2013

#### Cement production

The volume of cement production produced in 2012 was 174 Mt (Cembureau, 2014). The cement industry accounts for around 40% of all energy use in the non-metallic minerals sector.

Cement production data by country are frequently published by Cembureau and time series are available for this type of data. Figure 50 provides an overview of the EU28 countries with the highest cement production in 2012.

Figure 50: Production of cement in selected European countries and country groups in 2012.

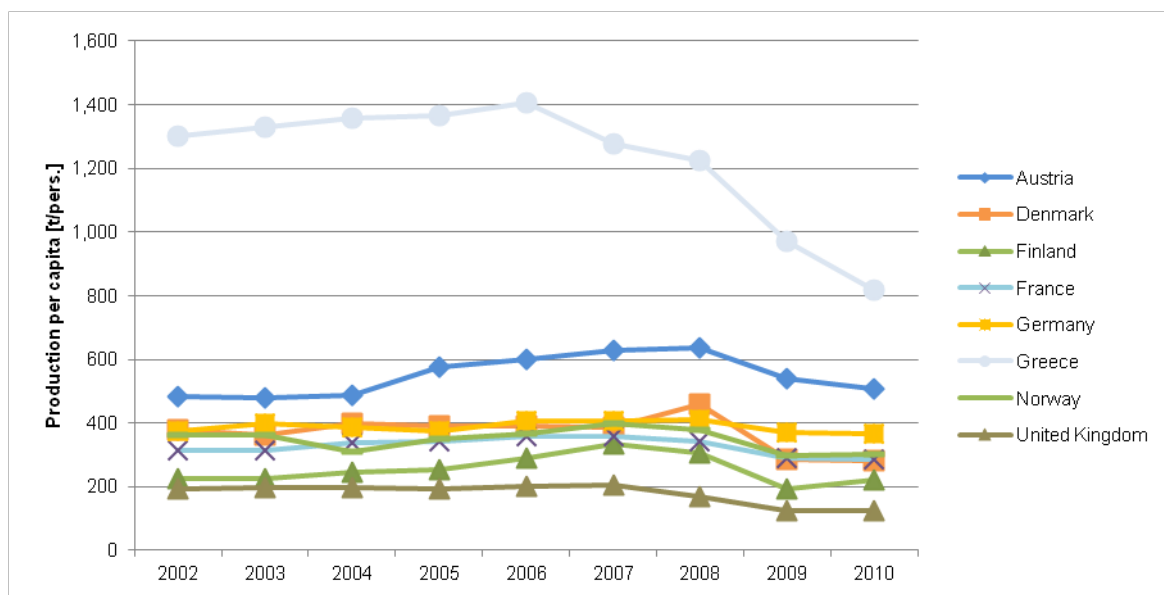


Source: Cembureau, 2014

Notes: Some countries have been grouped together. Group One: Denmark, Finland, Sweden, Ireland. Group Two: Czech Republic, Croatia, Estonia, Latvia, Lithuania, Hungary, Slovenia. Group Three: Cyprus, Portugal, Greece, Romania, Slovakia, Bulgaria. Group Four: Austria, Belgium, Luxembourg, the Netherlands

Between 1990 to 2012 cement production per capita in the EU28 is between 300 and 700 tons per capita/a for most countries and remained relatively stable during this period (Figure 51). The relatively high per capita production in Ireland, Luxemburg, Portugal, Spain and Cyprus is based on intensive construction activities. In these countries the number of buildings constructed per 1,000 inhabitants was more than twice as much as the European average (Euroconstruct, 2013). In most of the other countries cement production per capita decreased in the period analysed.

Figure 51: Cement production per capita between 2002-2010 (only selected countries are shown).

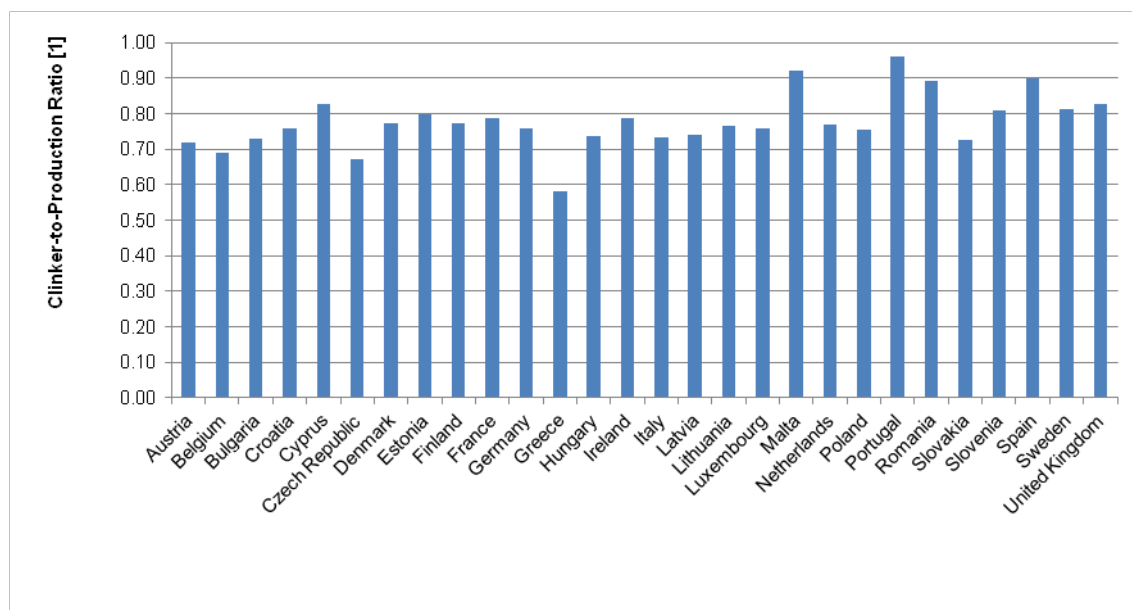


Source: Cembureau, 2014; Eurostat, 2015

To determine the amount of clinker produced per year the production data need to be divided by the clinker-to-production ratio. The clinker-to-production ratio is provided by country by the Odyssee database from Enerdata. These data are primarily available for the large cement producing countries so that estimates need to be generated by analogy assumptions for some countries. In Figure 52 the clinker-to-production ratio is depicted for the EU 28 countries in 2010.



Figure 52: Clinker-to-production ratio (Clinker production divided by cement production) of the EU28 countries in 2010.



Source: Enerdata, 2015

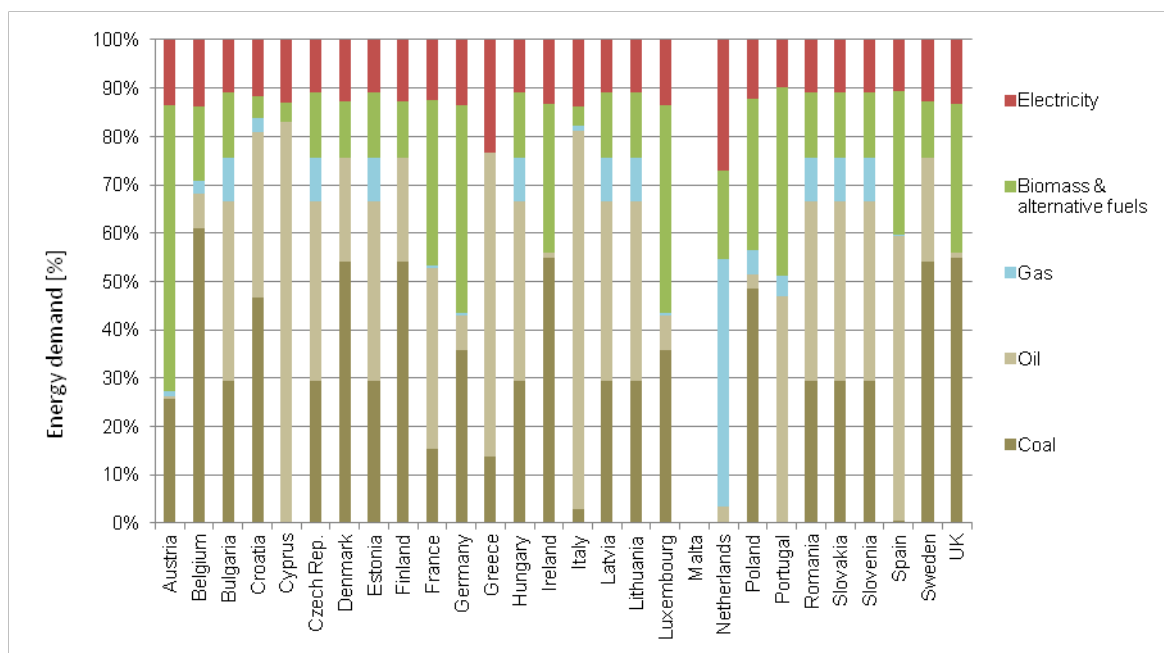
Notes: Estimations need to be made for Denmark, Estonia, Finland, Greece, Hungary, Ireland, Latvia, Lithuania, Luxembourg, Netherlands, Slovakia, Slovenia, Spain, Romania, Bulgaria and Croatia

Availability of technology stock distribution data for the cement sector is very limited. Cembureau published their last overview of the stock distribution in 2002. Thereafter, no data source provides fundamental new insights regarding stock development over time.

### Energy demand

Combining the data of specific thermal and electricity demand together with production and clinker-to-production ratio data leads to the final energy demand attributable to cement production (Figure 53). The entire energy input, apart from electricity, is transformed into heat.

Figure 53: Share of fuel type in total final energy demand for cement production in the EU28 by country in 2012.



Source: Cembureau, 2014; Enerdata, 2015; own calculations

### 3.5 Furnaces in the glass industry

#### 3.5.1 Scope and description of technology

Glass melting is an energy intensive process. In 2012, glass melting in the EU consumed about 102 TWh of final energy, mainly natural gas. This equates to about 3% of total industrial final energy demand in the European Union.

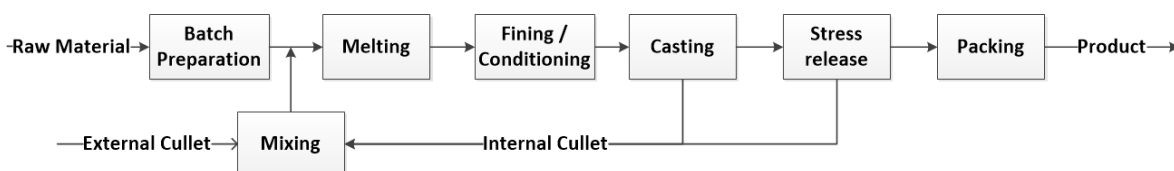
Products made of glass are ubiquitous in everyday life. Glass is used in various forms and applications and is produced by melting raw materials (mostly silicon oxide) and casting it into the desired form. For this study glass products are distinguished into the following sectors.

- Container glass for beverages and other liquids
- Flat glass for windows or windscreens
- Glass fibre for, for example, reinforcement of plastics
- Glass used in Other forms

Due to the high temperature needed in the melting process, glass production is energy intense. Natural Gas and Fuel Oil are primarily used to provide sufficient heat for the process. Due to the decomposition of some of the ingredients the process of glass production emits CO<sub>2</sub> in addition to that caused by the burning of the fuels.

The production of glass can be divided into several steps, which are shown in the following figure.

Figure 54: Glass production process



Source: based on Fleiter et al 2013; Worrellet al 2008

The figure gives a rough overview of the process and the individual production steps are described below. The scope of this study is on the energy-intensive melting and fining steps, which both take place in the furnace.

#### Batch Preparation

*The raw materials, which are mixed in special tanks, are primarily silicon oxide followed by alkali- and earth-alkali oxides..* Pure quartz-sand requires temperatures above 2000 °C to be processed into glass. In order to lower the melting temperature, reaction agents are added to the raw-material mixture. The most important agent is sodium oxide (Na<sub>2</sub>O), which is applied through soda ash (Na<sub>2</sub>CO<sub>3</sub>). This becomes sodium oxide as it melts, releasing carbon dioxide as it does so (IPPC 2013; p. 41). The third largest group of ingredients are lime oxide (CaO) and magnesia (MgO). Like soda ash they are added as carbonates to the raw material mixture (Schaeffer 2014; p.132).

Further ingredients that are used in smaller percentages are, for example, sodium sulphate, which is added to help purify the molten glass. The sulphate builds sulphate oxides which form gaseous bubbles. Other gases trapped in the molten glass are combined in the bubbles and leave the furnace (Schaeffer 2014; p.133).

The use of cullet is very common in the melting of glass as it reduces the energy

needed for melting. Cullet is broken glass which comes either from external sources or from rejects in the production process. In addition, less soda ash is needed in the mixture of the raw materials since it is already incorporated in the cullet.

### **Melting**

Glass melting furnaces are usually rectangular tanks with a vaulted ceiling, made of refractory bricks. The bricks are enclosed by an external steel construction.

At the entrance of the furnace raw material is continuously inserted into the tank through the so called doghouse. Burners under the ceiling of the furnace heat up and melt the input materials. In the heating process the moisture within the raw material evaporates, and trapped gases escape. At 500 °C the first decarbonisation starts and the melting of the raw materials begins between 750 and 1200 °C. The silica from the quartz sand and the sodium oxide from the soda ash combine, while huge volumes of gases, especially carbon dioxide, escape because of the decomposition of other ingredients. The primary melting is completed when the molten glass becomes transparent. Due to the loss of gases and the elimination of interstitial spaces the volume of the molten glass will be reduced to 35 to 50 % of the initial volume of the raw material (IPPC 2013; p.42)

The furnace is the main consumer of heat in the glass production process. Accordingly, this chapter and the data collection will focus on the furnace.

### **Fining and Conditioning**

In the furnace, the glass passes through different zones in which the raw materials melt and homogenise. After the glass has been melted it is important that the molten materials build into a homogenous mass. To do this, all trapped gases must be eliminated and the different input materials must be evenly distributed. This is achieved by mixing the molten glass using differences in temperature and the process is supported by fining agents (IPPC 2013, p.43ff).

The conditioning is the final part of the melting process. The conditioning zone of the furnace is disconnected from the rest of the furnace tank by a weir. In this step the molten glass is slowly cooled down to temperatures between 900 and 1350 °C (IPPC 2013, p.45).

### **Casting, Annealing and Packing**

After the cooling and conditioning steps, the molten glass is taken from the far end of the furnace and processed into the desired product. An important step is the controlled cooling of the products, since uncontrolled (fast) cooling leads to tensions within the product, making it vulnerable to external force. Afterwards the product can be packed and shipped.

### **List of technologies analysed**

The following technologies are briefly discussed in the chapter that follows:

- Regenerative fired furnaces
- Recuperative fired furnaces
- Furnaces fired with oxygen instead of air

- Furnaces using electric melting

The information used in this project on the capacities and used technologies is based on the database of the *glassglobal group*<sup>14</sup>. This group has substantial technical expertise in the sector and has established their database over the past 13 years. Data on the technologies used in the countries that are in the scope of this study are available in the *plants.glassglobal study*. The database contains information on the technologies used, the capacity per day/year, the location, the main product and in some cases the year of construction. It must be stated, however, that the publisher of the database doesn't guarantee full coverage of all furnaces installed. Nevertheless the database seems to provide a representative picture of the European glass industry.

Furthermore, technical data and information is gathered using the Best Available Technique Reference Documents (BREF) for the Manufacture of Glass and other scientific sources (IPPC 2013). It contains information on technologies and specific energy consumption whereas it does not give an accurate picture on the technologies in stock.

### 3.5.2 Technology characterisation

This section begins with an overview of different furnace types used in glass production and then discusses individual furnace types. This is followed by the discussion of add-ons such as waste heat recovery and finally the heat consumption and the thermal efficiency are considered.

The average **lifetime** of a glass melting furnace is 20 years. After 10 to 14 years a major renovation takes place, in which the refractory materials are changed.

The **cost** of a furnace is dependent on the technology used and its size. There is little information available on the cost of a furnace. It is stated that an installation of a medium sized furnace with a capacity of 250 t/day costs in the range of 40 to 50 million Euros and the renovation costs between 3 and 5 million Euros (Jochem et al. 2008; p.240f). In the flat glass sector a plant with a capacity of 500 to 1000 t/d costs approximately 120 million Euros. The cost of the major renewal (after 12 to 14 years) is in the range of 30 to 50 million Euros (Jochem et al. 2004; p.240f).

The melting of the raw materials into glass requires significant heat. For most glass composition the theoretical minimum **specific energy consumption** (SEC) required amount of energy is between 2.10 and 3.24 GJ/t (IPPC 2013, p.92). As the required heat changes with the formulation of the input material, other sources give different values for the theoretical minimum; values of 2.50 GJ/t; 2.60 GJ/t or 2.68 GJ/t are indicated (Schaeffer 2014, Worrell et al. 2008; Fleiter et al. 2013).

Burners for heating the input materials are either positioned on both sides of the tank, or on the front or rear end. The burners are integrated in ports which feed the combustion air into the furnace.

Some furnaces have electrical heating that can boost temperature. This is usually applied as resistant heating. Furnaces with small capacities can use resistant heating as their main heat source.

**Capacities** of glass melting furnaces range from small installations of 25 to 100 tons

---

14 [www.glassglobal-group.com](http://www.glassglobal-group.com)

per day through medium-sized furnaces (100 to 500 tons per day) to large furnaces exceeding 500 tons per day (IPPC 2013, p. 45).

The most common furnace types are described below. They differ in the way they recover heat from flue gas and in the way they heat the input materials.

### **Regenerative Furnaces**

In this type of furnace the heat of waste gas is used to preheat the combustion air. This is carried out using heat absorbing refractory material. The furnace has two sets of burners which are operated alternately. When a set of burners is in operation the waste gas leaves through the combustion air ports of the second burner set. In these ports the refractory material absorbs the heat from the waste gas. After a set amount of time the operating burners are switched off and the direction changes. At this point the refractory material heats up the combustion air for the second set of burners. The pre-heated air has temperatures of between 1200 and 1350 °C (IPPC 2013, p.47).

Regenerative furnaces can be split into cross-fired and end-fired furnaces.

In *cross-fired (or side-port) regenerative furnaces* the position of the burners and the ports is on both long sides of the furnace. The flame passes over the molten glass and directly into the ports positioned on the opposite side. This design is used in large installations. It enables the operator to produce different temperature zones along the furnace (IPPC 2013, p. 47ff) (Agureev 2013).

*End-fired (or end-port) regenerative furnaces* are operated in the same way as cross-fired furnaces. The difference is that the burners and ports are positioned next to each other at one end of the furnace. This forces the flame into a U-shaped path. End-fired furnaces are more energy efficient than cross-fired furnaces, due to the longer path of the flames. The thermal efficiency is up to 10 % higher than in cross-fired regenerative furnaces (IPPC 2013; p. 311f). They are usually used for medium to small sized capacities, since the tank size has an upper limit of 150 m<sup>2</sup> (IPPC 2013, p. 47ff).

### **Recuperative Furnaces**

Another type usually used for smaller sized furnaces is the *recuperative glass melting furnace*. Recuperative furnaces use a continuously working heat exchanger to transfer heat from the waste gases to the combustion air. The burners are positioned at the same location as in the cross-fired furnace. The difference though is a special waste gas port in the furnace through which the waste gases leave the furnace. Due to material properties of the heat exchanger the temperature of the pre-heated air is limited to approximately 800 °C. Recuperative furnaces are less energy efficient than regenerative furnaces due to the lower air pre-heating temperature. Consequently they are not very common, have only small shares of capacities and new installations tend to use regenerative furnaces (IPPC 2013, p. 49).

### **Oxy-Fuel Furnaces**

A special technique is *oxy-fuel burners*. These burners use oxygen with a purity of up to 90 % instead of combustion air. The advantage of these burners is that the atmospheric nitrogen isn't carried through the process, which results in a higher efficiency than conventionally heated furnaces, where the nitrogen has to be heated and carried through the process. The disadvantage is the energy required to produce the oxygen. It is still considered a developing technology and is being established in smaller sectors like glass fibre and special glass (IPPC 2013, p. 50).

### **Electric melting furnaces**

*Electric melting* is used in smaller sized furnaces. It is used because the thermal efficiency of fossil fuel is lower in smaller furnaces. As mentioned above the heating via electricity uses the resistance of the molten glass itself. This requires the raw materials being heated by fossil fuels at the start of a furnace campaign. As the glass becomes molten the conductivity increases and therefore allows resistant heating to be used. As with fossil fuelled furnaces, the electric-melting furnace is built out of refractory materials enclosed in a steel frame. The electrodes are either inserted from the top, the side or, most commonly, from the bottom. The lifetime of an electric melting furnace is between 2 and 7 years (IPPC 2013, p 50f).

Furthermore it must be mentioned that electric melting is only used to a certain furnace capacity. This capacity is in the range of 300 tonnes/day. This is because the efficiency of conventional (fossil-fuelled) furnaces is higher in larger furnaces. Furthermore the costs of electricity are higher than for mineral oil or natural gas.

After having discussed the main technologies the following paragraphs deal with technologies that can be used to support the melting, or open the process to further heat sources.

### **Electrical Boosting**

In order to increase control over temperature, some fossil-fuelled furnaces have an electrical boost. The boost consists of electrodes positioned at the side or the bottom of the furnace. With this boost the operator of a furnace is able to introduce an extra amount of heat into the furnace and increase the throughput to address peaks in demand. Usually the energy input can be boosted by 5 to 20% by this resistant heating. However it does not make sense to use this as a long term solution, since it generates higher production costs (IPPC 2013, p 51).

### **Use of Biogas**

Conventional furnaces rely on mineral oil or natural gas as their primary heat source. An exception can be made for the electric melting furnaces. Natural gas use is increasing because of its ease of control, high purity, economy, lower storage requirements and lower sulphur dioxide emissions. The main advantage associated with mineral oil is a better heat transfer for the melting process due to more radiant flames (IPPC 2013; p. 46).

The use of biogas is still an R&D topic. For example, the company Verallia is researching the possibility of using biogas in its furnaces in the plant in Bad Wurzach, Germany. The target is to substitute up to 50% of the required fossil fuels with biogas from a nearby production facility. The test started in June 2015 and will continue for at least six months. Unfortunately there is as yet little information available (Verallia 2015).

### **Use of Waste Heat**

As described above, the amount of heat leaving the furnace with the flue gas depends on the installed air pre-heating system. The waste gas has temperatures between 300° C and 600° C on leaving the pre-heater. The heat in the waste gas can then either be utilised to produce steam or to pre-heat the raw materials.

The BREF on glass states that the first option is no longer economically feasible, since the air pre-heating systems generate too little heat for economical operation of the boilers (IPPC 2013; p. 316).

The pre-heating of batch material on the other hand is reported to achieve 10% to

20% of energy savings.

### **Specific energy consumption (SEC)**

The specific energy consumption per tonne of molten glass varies in the different sectors, and it is also dependent on the type of furnace. An overview of the various SEC discussed in the literature is provided Table 46 for different kinds of applications and operation modes.

The following observations can be drawn from this overview. First of all, the theoretical minimum as stated in (Schaeffer 2014; IPPC 2013; Worrell 2008) cannot be met by existing furnaces. The lowest values are achieved by oxygen fired furnaces. This value must be viewed with care, however, because the production of oxygen isn't mentioned. Low values can also be achieved by electric melting furnaces. It has to be borne in mind, however, that they are only practical to a certain capacity (300 t/d).

In regards of furnace size one can envisage that larger furnaces need less energy to produce the same amount of molten glass.

The values are dependent on the quality requirements of the product. This is also discussed in the following section.

It has been decided to rely on the values stated in the BREF document on glass (IPPC 2013), since these values contain the most explanation and appear to be the most accurate.



Table 46: Ranges of specific energy consumption for different glass types.

Glass type	Further information			[GJ/t melted]			Source
	furnace type	Throughput	Cullet	min	mean	max	
flat/container	theoretical minimum			-	2.68	-	IPPC 2013 p.92
flat/container	theoretical minimum			-	2.56	-	Worrell et at 2008 p. 18
flat/container	theoretical minimum			-	2.60	-	Schaeffer 2014
container glass				-	5.40	-	Fleiter et al 2013 p.474
container glass	regenerative end fired	260 t/d	83%	-	3.62	-	IPPC 2013 p. 93
container glass	regenerative side fired	40 - 500 t/d	70%	-	4.20	-	IPPC 2013 p. 95
container glass	regenerative end fired	30 - 450 t/d	70%	-	3.80	-	IPPC 2013 p. 95
container glass	recuperative	40 - 450 t/d	70%	-	5.00	-	IPPC 2013 p. 95
container glass	All oxygen fired	350 -425 t/d	70%	3.05	3.28	3.50	IPPC 2013 p. 95
container glass	regenerative end fired		50%	3.40	4.80	10.70	IPPC 2013 p.102
container glass	regenerative side fired		50%	3.3	4.60	6.60	IPPC 2013 p.102
container glass	recuperative		50%	4.1	6.30	11.60	IPPC 2013 p.102
container glass	All oxygen fired	with oxygen prod.	50%	3.50	4.70	5.20	IPPC 2013 p.102
container glass	electric melting		50%	2.90	3.30	3.60	IPPC 2013 p.102
container glass	not mentioned			-	4.70	-	Schaeffer 2014 p.138
container glass	regenerative			6.17	9.08	12.45	Worrell et at 2008 p.19
container glass	electric melting			2.91	3.26	4.42	Worrell et at 2008 p.19
container glass	All oxygen fired			5.00	5.47	5.94	Worrell et at 2008 p.19
flat glass	regenerative side fired			5.70	11.00	6.30	Agureev 2013 p.3
flat glass	not mentioned			-	11.40	-	Fleiter et al 2013 p.474
flat glass	regenerative side fired			5.20	7.50	8.70	IPPC 2013 p. 121

## Work package 2: Assessment of the technologies

Glass type	Further information	[GJ/t melted]					Source
		furnace type	Throughput	Cullet	min	mean	
flat glass	regenerative side fired	150 - 900 t/d	20%	-	6.30	-	IPPC 2013 p. 95
flat glass	regenerative side fired	600 t/d	25%	-	6.48	-	IPPC 2013 p.93
flat glass	not mentioned			-	6.50	-	Schaeffer 2014
flat glass	regenerative			7.68	10.24	14.43	Worrell et al 2008 p.19
flat glass	All oxygen fired			-	6.29	-	Worrell et al 2008 p.19
glass fibre	not mentioned			-	5.40	-	Fleiter et al 2013 p.474
glass fibre	not mentioned			7.00	12.50	18.00	IPPC 2013 p. 130
glass fibre	recuperative			6.98	8.15	9.31	Worrell et al 2008 p.19
glass fibre	electric melting			3.49	8.73	13.85	Worrell et al 2008 p.19
glass fibre	All oxygen fired			3.96	6.52	9.08	Worrell et al 2008 p.19
other	not mentioned			-	13.20	-	Fleiter et al 2013 p.474
other	recuperative	15-120 t /d	40%	6.70	8.85	11.00	IPPC 2013 p. 95
other	regenerative side fired	40 - 60 t/d	40%	8.00	9.50	11.00	IPPC 2013 p. 95
other	regenerative end fired	120 - 180 t/d	40%	5.00	5.50	6.00	IPPC 2013 p. 95
other	electric melting			4.00	5.50	7.00	IPPC 2013 p.136
other	conventional (recuperative or regenerative)			4.80	7.40	10.00	IPPC 2013 p.136
other	not mentioned			5.00	11.00	17.00	IPPC 2013 p.142
other	not mentioned			-	9.40	-	Schaeffer 2014 p.138

### Thermal efficiency

As with the SEC, the thermal efficiency is also affected by a broad set of variables. This study essentially relates the thermal efficiency of the glass production processes to the theoretical minimum energy demand for melting glass. The BREF document on glass suggests this point is between 2.1 and 3.24 GJ/ tonne of melted glass, depending on the composition. In reality, however, this value is far from being met. This is

because of the quality requirements of the glass in addition to losses which will be discussed later. As described above, gases have to be eliminated from the molten glass. To do this the glass remains in the furnace and purifying agents are added to the raw materials. The time taken for this process depends on the glass product, giving rise to different levels of energy consumption.

The aging of the furnace also contributes to higher energy demand. It is stated, that the energy demand per tonne of melted glass increases by about 1.5% to 3% (IPPC 2013; p. 114) with every year. This leads up to 20% higher energy demand per tonne of melted glass by the end of the furnace campaign (IPPC 2013; p.93).

The usage of cullet has a notable effect on the energy demand. Since cullet already incorporates the sodium oxide needed from soda ash, the energy demand for re-melting of cullet is lower. Literature states that the energy demand decreases by 2.5 % to 3 % per tonne of melted glass for every 10 % of cullet in the input material (IPPC 2013; p.314f). Knowing this the glass industry tries to use as much cullet as possible. Nevertheless this is only feasible to a certain degree, since there is not always sufficient high purity cullet available (Levitin et al. 2012)

The thermal efficiency of the melting process is also greatly dependent on the amount of heat that can be recovered. Heat leaving the furnace with the flue gas is lost if it isn't recovered in some way. As explained before, most furnaces recover this in order to pre-heat the combustion air. In general, regenerative pre-heating utilises more of the heat in the flue gas, since the temperature restrictions are higher in these than in recuperative pre-heaters. The amount of heat retained in the pre-heater depends on its size and, with regard to regenerative air-pre-heaters, on the number of refractory bricks used. The number of refractory bricks and size of a regenerator must be specified for technical and economical considerations.

Finally the isolation of the furnace plays an important role in the thermal efficiency of the process.

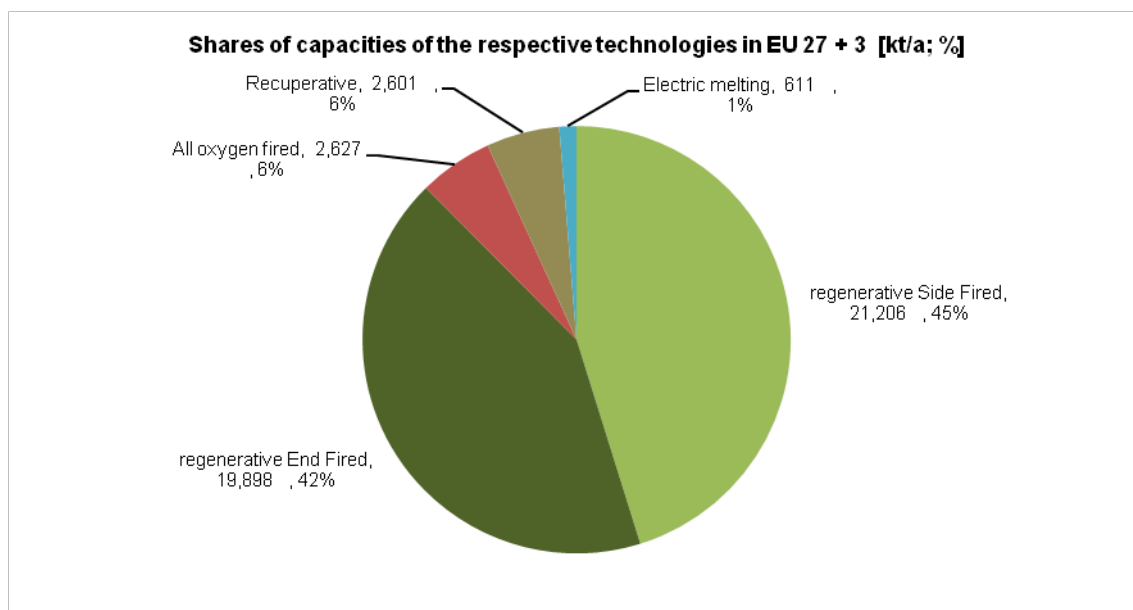
Literature states that modern regenerative furnaces have an overall thermal efficiency of about 50%, with waste gas heat losses in the range of 25% to 35%. These can be reduced to 14% to 20% when using cullet and raw-material pre-heating. In comparison, recuperative furnaces only reach a thermal efficiency of 20% to 30% without further heat recovery (IPPC 2013; p.320).

### **3.5.3 Technology stock distribution**

In this section the distribution of the technologies described above are discussed.

Figure 55 shows the distribution of capacities among the different technologies within Europe. The installed capacity totals 47 Mt/a. It is obvious that regenerative furnaces make up the huge majority of furnaces and that electric melting, recuperative furnaces and oxygen fired furnaces only provide a small proportion of the total capacity.

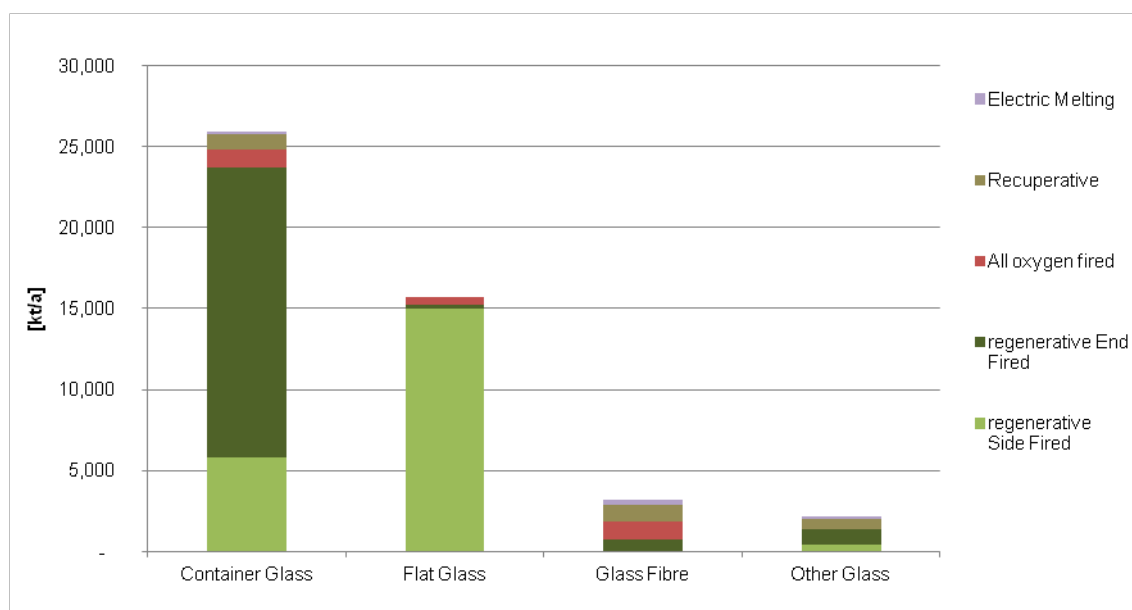
Figure 55: Shares of capacities of the respective technologies in EU28 and Norway, Switzerland and Iceland [kt/a; %].



Source: [Plants.glassglobal](#)

Figure 56 shows the technology distribution in the different sectors. This figure again underlines the conclusions that have been made on the two main sectors. The container glass sector mostly operates regenerative furnaces: either end or side fired. In the flat glass sector the vast majority of furnaces utilised are regenerative side fired furnaces. The two minor sectors of glass fibre production and other glass rely on more diverse technologies.

Figure 56: Technologies used in the different Glass sectors the EU 28 and Norway, Switzerland and Iceland; Capacities in [kt/a].



Source: [Plants.glassglobal](http://Plants.glassglobal)

Table 47 shows the number of installations of the different furnace types. It furthermore gives the mean capacities of the respective furnaces. Regenerative side fired furnaces have a mean capacity that is almost twice as high as the capacity of the regenerative end fired furnaces.

It can again be noted that the vast majority of furnaces use regenerative air pre-heating. Electric melting furnaces are particularly used in smaller applications in market niches with special product requirements.

Table 47: Installed furnaces and mean capacities in EU28 and Norway, Switzerland and Iceland.

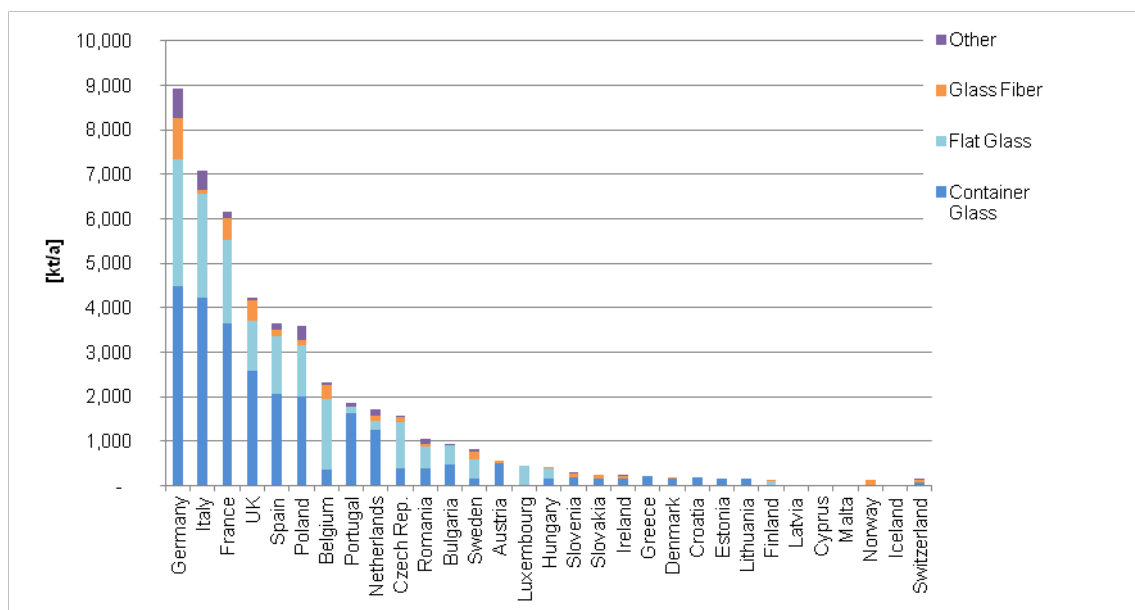
Type of Furnace	Number of installations	Mean capacity [kt/a]
Regenerative Side fired	158	134,22
Regenerative End fired	281	70,81
All oxygen fired	45	58,38
Recuperative	62	41,96
Electric melting	19	32,14

Source: [Plants.glassglobal](http://Plants.glassglobal)

The distribution of capacities and technologies in the countries of the EU28 +3 will be discussed after having examined the different technologies in detail.

Figure 57 shows the capacity distribution in Europe, which also gives the capacities of the respective sectors. Container glass represents the largest proportion of production capacity, and it also contributes the highest share in each country and its furnaces provide the largest capacities. Germany is the biggest producer and is followed by Italy, France and the United Kingdom. Almost all EU28 countries have some glass industries operating furnaces.

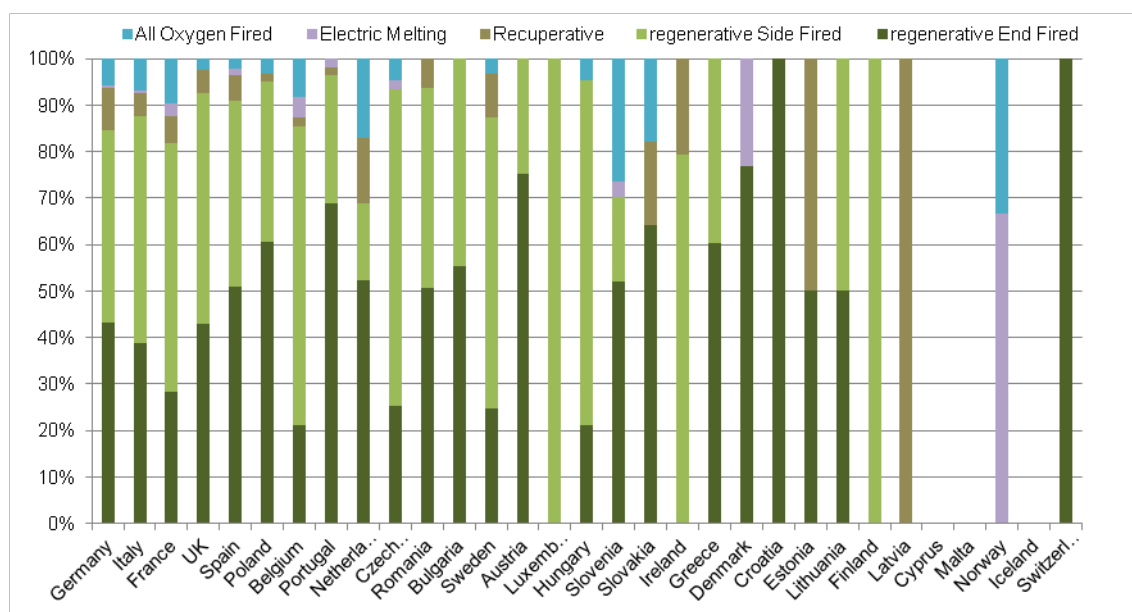
Figure 57: Installed capacities [kt/a] by country divided by production sectors in 2012.



Source: [plants.glassglobal](http://plants.glassglobal)

The capacities of the respective countries with regard to the technologies are displayed in Figure 58. Obviously the total capacity of each country is as in Figure 57. Figure 58 again shows how the regenerative furnaces provide the largest capacity. The recuperative furnaces have only a very small impact on the overall capacities. While country differences can be observed, the countries with large production capacities use a largely comparable technology mix: 80-90% regenerative furnaces and 10-20% oxygen and recuperative furnaces.

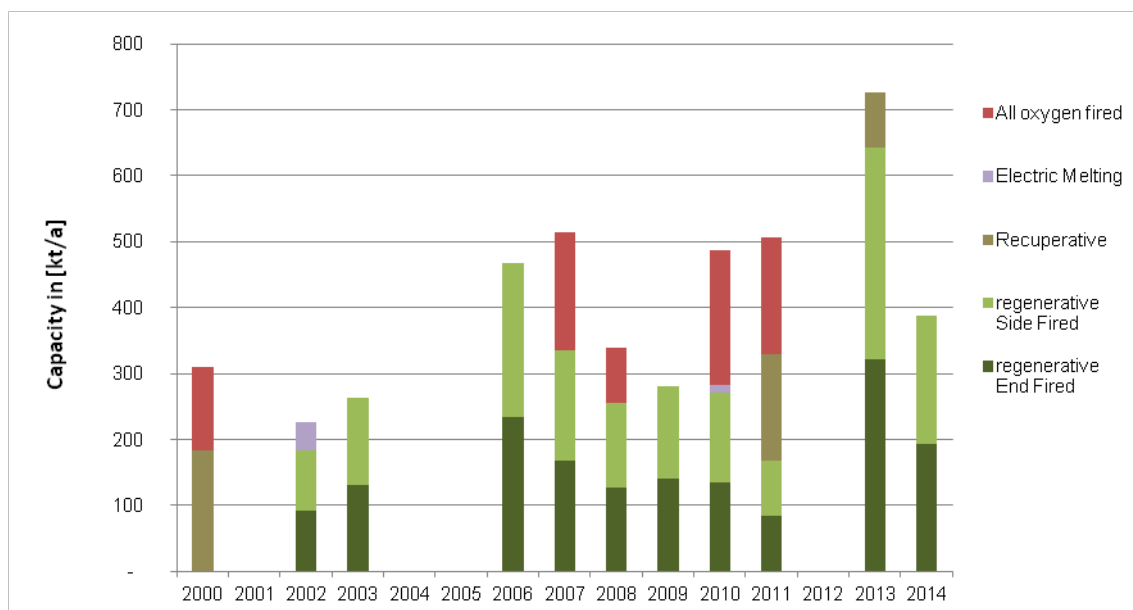
Figure 58: Installed Capacities by country and technology in 2012 [kt/a].



Source: [Plants.glassglobal](http://Plants.glassglobal)

Regarding the age distribution of the stock of technologies it must be noted that there is very little data available that provides a full view of the furnaces. The only information found was taken from the dataset provided by glassglobal. Even here, the construction year is only available for the container glass industry and the information may not be complete. The study only contained information starting in the year 2000 and so Figure 59 illustrates the capacities that have been built since then. The different colours represent the different technologies that have been used. Most of the furnaces built have been equipped with regenerative air-pre-heaters, however between 2000 and 2014 three recuperative equipped furnaces have been built. This is remarkable, bearing in mind that recuperative furnaces are commonly regarded as being less thermally efficient. These furnaces may have been rebuilt in existing plants and thus the installation of a regenerative air pre-heater wasn't technological or economical feasible. However, this data has to be treated with caution and it might not be representative of the entire glass industry.

Figure 59: New furnace capacities in container glass industries since 2000 [kt/a] in EU28 and Norway, Switzerland and Iceland.



Source: [Plants.glassglobal](http://Plants.glassglobal)

Summarising the data presented, some conclusions can be drawn. The European glass industry heat supply mainly focuses on the use of fossil fuels, especially natural gas. The use of alternatives, such as biogas, is a topic of current research. Electricity is only used in special cases and market niches, but it is not economically viable for standardised large scale furnaces.

The technology stock is dominated by regenerative furnaces and will remain so in the near future. With an average furnace lifetime of about 20 years, changes in the plant stock are relatively slow, but they are still a lot faster than, for example, in the steel sector.

When considering the individual glass types, container glass and flat glass represent the major share in capacity and energy consumption.



### 3.6 Process cooling

#### 3.6.1 Scope and description of technology

Refrigeration and process cooling can be accomplished by different technological means. However, the most commonly technology used in Europe and worldwide corresponds to the *compression cycle* (see description below). In simple terms, the state of the refrigerant will change to either liquid or vapor by changing the pressure of the refrigerant. This means that the refrigerant absorbs or discharges heat. Furthermore, process cooling can also be obtained by new technologies such as absorption and adsorption and steam jet cooling. Process cooling is used in industry for different purposes, e.g. as aid for production processes (Table 48)

Table 48: Examples of process cooling utilization in different industrial sectors.

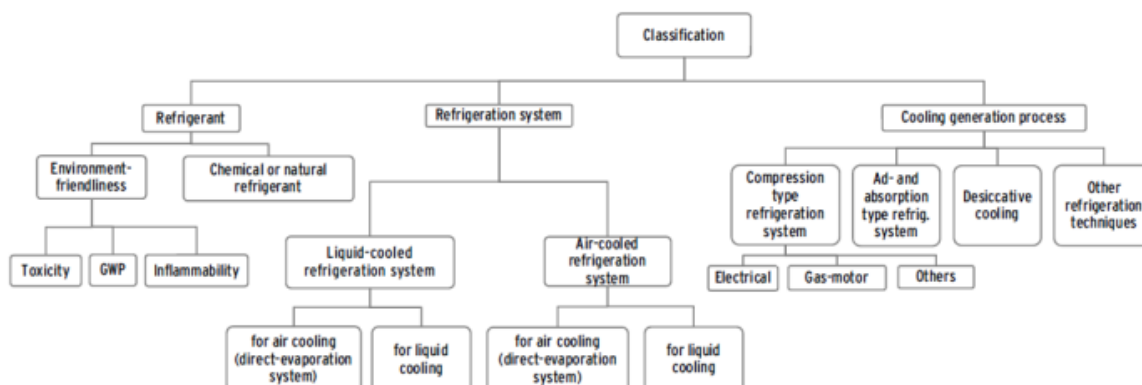
	Air Fractioning (<-30°C)	Deep Freezing	Low temperature (Plus cooling >0°C)	Dry freezing	Sterilization
Chemical industry	x	x	x	x	x
Medical	x	x	x		x
Petroleum refining	x	x	x		x
Pulp and paper			x		
Food Production		x	x	x	x
Agriculture		x	x	x	
Glass			x		x

Source: Reitze, 2013, UBA, 2015, VDMA 2012

The chemical and food industries have a relatively high share in process cooling capacities. In Germany, for example, these five sectors represent over 80 % of final energy demand installed capacity (Dengler, et. al., 2011). Specific process cooling applications include air fractioning and gas liquefaction for instance in the production of gases and basic chemicals. In the food industry, process cooling is also high with uses related to transport and storage of finished or semi-finished products in low temperature until 0°C. Deep freezing cooling is also important for the food industry in view of higher requirements for hygiene and increasing trends in fast food consumption (German association for refrigerated foods and German Institute for refrigerated foods, statistics and interview, 2014).

An overview of different process cooling technologies in industrial sectors includes technological aspects with respect to the cooling generation processes (see right part of Figure 61). Refrigeration systems in industry is available via liquid and air cooled refrigeration systems for different scales depending on the cooling demand required. Different refrigerants sorts play an important part on the sustainability operation of refrigeration systems. This effect can be observed in Figure 63. sorts play an important part on the sustainability operation of refrigeration systems.

Figure 60: Overview and classification of cooling systems.



Source: UBA 2015

## Cooling generation process

### Compression Cooling

Every compression cooling system has four basic elements which are run through by the refrigerant continuously:

- The evaporator is a heat exchanger on the suction side of the compressor. Liquid refrigerant evaporates under low pressure and low temperature. The heat needed to evaporate the refrigerant is taken from the medium to be chilled.
- In the compressor the evaporated refrigerant is compressed mechanically. It leaves the compressor at a high level of pressure and temperature (60 – 120 °C) still in gaseous form.
- The condenser is a heat exchanger on the pressure side of the compressor. The high-pressure refrigerant gas gives its heat to a cooling medium (air, water) and condenses. Afterwards the liquid refrigerant usually is held in an accumulator until it is needed.
- The throttle separates the high-pressure side of system from the low-pressure side. Further it meters the flow of the refrigerant into the evaporator and thereby the cooling power.

Different types of compressors increase the pressure of the refrigerant and are available in the market as: reciprocating compressors, scroll compressors, screw and centrifugal compressors.

### Reciprocating Compressors

The compression of the refrigerant in reciprocating compressors is driven by the use of motors and pistons as well as cylinders and valves. Reciprocating compressors can be divided into hermetic, semi-hermetic, and open types (Jarn, 2014).

For commercial, industrial refrigeration and air conditioning applications different types of semi-hermetic and open types are used today. In particular, semi-hermetic reciprocating compressors are high efficient especially in the range between 15 and 75 KW. These types are very competitive in industrial refrigeration equipments requiring on the other hand maintenance.

In Europe the demand for reciprocating compressors remained the same in 2014 as it was reported for the year before. This technology for cooling uses in Europe is very

advanced and well developed. The use of these compressors with inverter control systems is slightly growing in the EU market. The advantage of inverter control is to enable precision control of refrigeration capacity increasing efficiency.

### **Scroll Compressors**

Scroll compressors are also known as vertical scroll compressors and are frequently used in air conditioning applications while horizontal scroll compressors are commonly adopted in refrigerated transportation, storage showcases and medical applications. The demand in these sectors is expected to increase as different factors drive for this development (trend to refrigerated convenience food and aging population).

Increase in energy efficiency for this type of compressors is enhanced with inverter control technologies. This has enhanced their energy efficiency and energy performance. Due to this the scroll compressor has been adopted by Variable Refrigerant Flow (VRF) and PAC products.

Scroll compressors can be used in a broad range of applications in air conditioning systems (Room air conditioners (RACs), Partial air conditioners PACs) and Variable Refrigerant Flow (VRF) systems as well as in industrial and commercial chillers and heat pumps and refrigeration systems including freezers.

In Europe the demand for these compressors has been showing an increasing trend due to air conditioning applications. Furthermore, an increased demand is also observed for commercial and industrial refrigeration and lately for heat pumps applications. The use of both digital and inverter units have also been increasing (Jarn, 2014).

### **Screw Compressor**

The global demand for screw compressors increased to roughly 150.000 units in 2014 in three markets especially in China (67.000 units), Europe (35.000) and USA (31.000 units). Major producers of screw compressors worldwide are China, the United States, Germany, Italy, Japan, and Taiwan. Screw compressors are increasingly used for commercial and industrial refrigeration applications including refrigerated transport vehicles. Large industrial applications contain semi-hermetic and open-type screw compressors and have a high market share (Jarn, 2015).

Due to the dramatic reduction of compressor parts, screw compressors are easy to maintain, more competitive and high reliable. Most common capacities diverge from ca. 40 kW until 500 kW for larger applications. In addition, reduced noise and vibration is attained due to the moving main and secondary rotors. Furthermore, low space requirements and low weight are competitive advantages.

### **Absorption cooling**

The significant difference to the compression cooling is the absorber which consists of an absorber and a generator instead of the compressor. The mechanical energy as a driving energy source is replaced by heat, which is needed to drive the absorption cooling cycle. Inside the absorber circulates normally a solution of lithium bromide as absorbent and water as refrigerant.

- In the absorber water vapor is absorbed by the lithium bromide solution. The heat released in this process is given to the ambient air. At this point the solution is cold and has a high concentration.
- The diluted lithium bromide/water solution is pumped to the generator. By adding heat at a higher temperature level water is evaporated and the absorbent is dried out.
- While the resultant water vapor leaves the generator and passes into the con-

denser, the absorbent solution returns to the absorber and the process repeats. The condenser needs to be cooled, which is generally done by the same cooling tower as for the absorber.

- As vapor is absorbed in the absorber, the partial pressure of water drops below its vapor pressure. Thus, water evaporates in the evaporator that is directly connected to the absorber. The heat needed for evaporation is taken from the cooling cycle.

### Adsorption cooling

An adsorption cooling process is a periodical process with at least two separated chambers. Water is used as a refrigerant and silica gel or zeolite is used as the adsorber. In the process three different steps are performed:

- **Adsorption:** Chilled water is generated by evaporating water in the evaporator at lower pressure than vapor pressure. This chilled water is used for cooling. The vapor is adsorbed by the adsorber until saturated. Heat is produced in the adsorption process, which is removed to the ambient air or water.
- **Desorption:** Heat is added to the adsorber to dry it out. The adsorbed water is evaporated and condensed afterwards in the condenser by giving heat to the ambient air or water.
- **Heat recovery:** in a third step the heat from the warm chamber is recovered and transferred to the cold chamber to save energy.

During the entire process the condensed water from the condenser is conducted back to the evaporator to keep the process closed. The adsorption/desorption process takes place anti-cyclically in the two chambers.

As water is used as the refrigerant, the lower temperature limit is above freezing point, practically at about 5-6 °C. For silica gel adsorbers the dry-out temperature is at about 60-70 °C, for zeolite adsorber, temperatures above 90 °C is required.

Adsorption chillers have very few moving parts (only valves), they generate only low maintenance costs. Except of the regulation and eventual ventilators no electricity is needed. Besides, the used refrigerant has no global warming potential at all.

Adsorption chillers only reach low COP/EER values of 0.5 to 0.7. The construction needs to be well sealed to retain the vacuum.

Actually medium and high power chillers are very expensive and rarely build. As the adsorption chiller does not generate a constant heat (cooling) flow, a supplementary cold reservoir is needed to balance variation in temperature.

### Steam jet cooling

The Steam jet cooling system works after the same principle as the compression cooling system. Instead of mechanical compression it uses thermo-mechanical compression, run by steam.

- Therefore water is boiled and steam produced or steam from another process is used. This steam is accelerated up to ultrasonic velocity through a Laval nozzle.
- In the thermo-compressor the high speed steam generates a pressure that is below the vapor pressure of water.
- In the cooling chamber that is connected to the thermo-compressor water can now evaporate into the steam jet. This evaporation chills the water in the cooling cycle.
- The remaining steam has to be condensed and cooled down in a cooling tower.

Generally steam jet cooling systems are simply constructed and have few moving parts, so that they're quite reliable and easy in maintenance. Only water is used as a

refrigerant, the steam can be generated by waste heat or a solar system and the cooling power is well controllable. The temperature range is restricted to positive temperatures.

## **Refrigeration systems**

### **Industrial and commercial chillers as an example for process cooling**

Chillers are machines that extract heat from a liquid through vapor compression or through absorption/adsorption cooling as explained in the sections before. The extracted liquid is circulated through heat exchanges in order to cool air and processes (including other equipment) as required. In order to increase energy efficiency, resulting waste heat from the refrigeration process can be used for heating purposes if required.

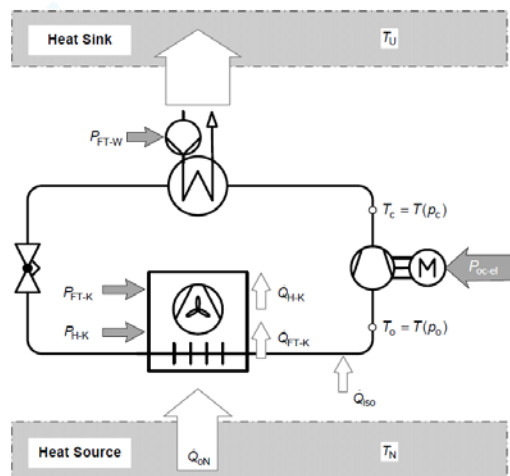
For industrial and commercial refrigeration, compression cooling is obtained by compact or centralized chillers using water or air as a condenser as well as in combination with cooling towers. For process cooling in industry and commercial sectors chilled water is conducted through the necessary processes or equipment. Chillers are used in European industrial sectors such as plastics including injection and blow molding, metal works, welding equipments and machinery, chemical processing including pharmaceuticals and gas cooling, food and beverage industries, paper and cement production, vacuum systems, semi conductors and compressed air. Special applications for cooling are found in medical equipment and lasers.

A combination of central and decentralized chillers applications for industry are found in the European Market depending on the cooling requirements load as well as applications location. Both systems have advantages and disadvantages. Refrigeration systems can be water/liquid or air based.

### **System boundaries and technologies analysed**

The refrigeration systems in industry and services sectors are very heterogenic across Europe. In compressor systems chillers the compressor and the refrigerant type in addition to the supply of electricity and exhaust heat comprise the most important elements of the system boundary. The set up of this boundary takes only partially into account the cold distribution system as the heterogenic layouts of different process cooling options in different type of industries and service companies (chemistry, supermarkets) make the generalization difficult. The system boundary of a compressor-based refrigeration system includes the evaporator, a mechanical compressor, a condenser and expansion valves (see figure Figure 61 below).

Figure 61: Scheme of a simple compression refrigeration showing the system boundaries.



Source: Arnemann et al., unpublished

A single solution for process cooling systems is not available in reality and a large variety of solutions are available depending on the process cooling demand of users.

### List of technologies analyzed

Currently in Europe the majority (over 90%) of refrigeration systems are based on compression technology using electricity as power source. Therefore, the analysis focused mostly on compression technologies. The current stage of analyses and data availability gathered until now allows only for an aggregated analysis for compression technology as a whole and not separately analysed for each compressor type.

Within industrial cooling systems the following technologies have been summarized under compression refrigeration:

- Compressor type of chillers with different type of refrigerants and compressors
- Thermally driven refrigeration systems (ad- and absorption type refrigeration plants)

### Potential applications for RES

Compression cooling systems embedded in different refrigeration systems in industry and commercial sectors use mostly electricity as input for producing cold at different temperatures for different processes. The potential applications for RES relate to the use of internal electricity sources based on renewable such as PV in industrial production halls or co-generation based on biomass. Thermal routes for cooling generation (i.e. absorption) exhibit the potential to integrate solar thermal as a source to produce cold.

### Review of available data sources

As the area of process cooling is not represented in Eurostat Statistics, direct contact was made with relevant associations in Europe and at member state levels together with cooling experts in some countries (Germany, Switzerland, UK, Austria, Belgium), with the objective of collecting public and non-publically available data. A formal data request including a template of desired information was sent to over 25 different institutions. The response rate was reasonable (over 50%) however the requested data

was in almost all cases nonexistent. The cooling process relies on very individual solutions for different types of clients and aggregated information has not been collected, except in some member states where studies on energy use and demand for process and space cooling has been conducted at sector level. Only stationary cooling units are analysed while transport cooling applications are not included in this analysis. The data gap for this application is very high.

Detailed desk research and analysis of specific cooling studies for Germany, Switzerland and UK was undertaken. On several occasions direct contact was pursued with the authors of these studies (cooling experts) as well as producers of particular chemicals (gases) with considerably high demand for cooling. The focus was on technological assumptions, allocated energy for process cooling, specific energy consumptions and analysis per branch, etc.

Companies dealing with cooling technologies offer different services for industry and tertiary users. These include the supply of components (e.g. heat exchangers), appliances as well as cooling plants and even complex industrial cooling plants. The spectrum of services includes planning, build up, manufacture, and installation including bringing up to service and dismantling of cool supplies in industry and service sectors.

This means that individual solutions are developed for the particular cooling demands of their processes. An overview of the solutions include cooling applications in medical technologies, laser technology for the production of machines, server cooling, special cooling uses in creameries and breweries, cooling boards for retail or for industry such as chemical processes, plastics production and pharmaceuticals. Particular energy intensive areas include cooling systems for air liquefaction or fractioning. The complexity of these solutions indicates that the lack of data that is communicated to statistical agencies with respect to this useful energy is significant.

### **3.6.2 Technology characterisation**

#### **Data used**

With respect to process cooling in industry, data for refrigeration systems across different industrial branches is scarce, in particular for installed capacities, number of units, energy efficiency options and energy demand. The main sources for the techno-economic assessment include three specialised cooling studies for Germany, a study on cooling demand from Switzerland as well as the different EU EcoDesign Directive preparatory studies for commercial refrigeration and industrial chillers (EU Commission, 2007, EU Commission, 2011, SVK, 2012). Information obtained from direct contact with relevant institutions across Europe did not provide further information on the relevant data surveyed in the framework of this work package. Therefore, the analysis on technology characterisation is based on the findings with cooling experts, literature research, expert-based assumptions to estimate capacities and number of units as well as statistical and technology provider data. The technological characterisation is structured along the input information required for the modeling activities within this project.

In the following, the individual data categories are discussed in terms of data sources and robustness of data.

#### **Energy Efficiency**

The efficiency of refrigeration systems is a challenging issue and depends on the system boundaries defined. Different types of efficiencies are possible to be defined including: the efficiency of the refrigeration system based on refrigerating capacity and total power needed as input. This is widely used in Europe known as the Coefficient of

Performance (COP) or in USA known as the Energy Efficiency Ratio (EER). Further efficiencies that can be defined in a refrigeration system include the efficiency of the cold production and use or the efficiency of the heat transfer as well as the efficiency of the fluid transport in the refrigeration system (Arnemann et al., unpublished; VDMA 2011). The COP or EER is defined for a specific operating condition of the refrigeration system under steady state conditions. Within this study we consider COP/EER as the efficiency definition.

$$COP = \frac{\text{usefull refrigerating capacity } \frac{W}{h}}{\text{total power input } \frac{W}{h}}$$

For the consideration of energy efficiency savings it is also possible to consider the coefficient of energy (COE) as indicator in energy units of the efficiency of the system but its value depends on the operating conditions of the system. By constant or very short operation of the system COP and COE will be the same. Further indicators as the European Seasonal Energy Efficiency Ratio (ESEER) differ from COE as they are calculated from COP and EER. For energy efficiency comparison refrigeration systems COP/COE is compared with the COP of a reference refrigeration system.

The COP describes the performance of the chillers as such (normally not including auxiliary equipment). The used coefficients of performance (COP) of different cooling systems used in this study represent the performance data of different manufacturers, which are based on idealised test conditions. Consequently these data stand for a theoretical range of values from the practical use in industry, but real-life chillers never operate in identical test conditions. The chiller itself is also only one of the parts of a cooling system (Rescue Workpackage 2).

COPs are not directly comparable across countries due to varying climate conditions, technical specifications and test procedures (IEA 2011). In practice, the actual COP of cooling systems in the sub-branches of industry (e.g. food industry, chemical and petrochemical industry, pulp and paper industry) in Europe also depends on the real working conditions and a number of influencing factors. Factors, which influence the operational COP of the cooling systems, are for example (Baillargeon et al. 2011; Waide, Riviere & Watson, 2011; Burba, 2013; Clark, 2013; Frisco, 2008; Garcia et al. 2012):

- type of cooling technology (e.g. compression cooling, sorption cooling, water cooled, air cooled, etc.),
- installed capacity of chillers,
- chiller load and duration of cooling,
- age of cooling systems,
- operating ranges (e.g. cooling water temperature, etc.),
- condenser conditions,
- system boundary (normally the coefficient of performance is primarily concerned with the core refrigeration system),
- intended use (process cooling, air conditioning, etc.) and
- type of used refrigerant.

Different efficiency ranges are possible for compression based systems and alternatives such as absorption cooling and desiccative evaporative cooling. The highest efficiencies are obtained by established compression cooling systems for a wide range of cooling temperatures.



Table 49: Overview of available technologies for industry and services sectors.

	Compression Cooling Device	Absorption Cooling with NH <sub>3</sub>	Absorption Cooling with LiBr	Absorption Cooling	Adsorption Cooling DEC 1) -Cooling Plant
Physical Cooling-effect	Vaporization of the Cooling Medium				Evaporation of the Cooling Medium
Principal of Concentration	Mechanical Concentration	Thermic, Absorption Solution Circulation		Sorption Humidity Removal	Sorption Humidity Removal
Operating Power	Electrical Energy	Thermal Energy 85 ..... 120 ..... 180 °C	Thermal Energy 85 ..... 180 °C	Thermal Energy 55 ..... 95 °C	Thermal Energy 50 ..... 100 °C
Cooling medium	Chlorinated or Chlorine-free Hydrdocarbon	Water with NH <sub>3</sub> as Absorbing Material	Water with LiBr as Absorbing Material	Water with Particulate Material as Absorbing Material (SILICA-Gel)	Water
Specific Primary Energy Consumption <sup>2)</sup>	1,3 ..... 1,65	0,6 ..... 1,0	0,6 ..... 1,0	0,4 ..... 0,6	0,3
Performance number /COP <sup>3)</sup>	3 ..... 5	0,3 ..... 0,55 ..... 0,7	(1-st) 0,6 ..... 0,75 (2-st) 1,0 ..... 1,3	0,4 ..... 0,6	0,5 ..... 0,7 per Air Status
Cooling Temperature	-50 ..... 15 °C	-50 ..... -10 ..... 5 °C	5 ..... 15 °C	6 ..... 15 °C	4 ..... 8 K Humidity Removal
Cooling Capacity	50 ..... 5000 kW	150.....1100... .. 5500 kW	15 .....400 ..... 5000 kW	50 .....450 kW	20 ..... 350 kW
Specific Module Price	75 ..... 125 €/kW	400...600..1 800 €/kW	100 ..... 220 ..... 1000 €/kW	250 ..... 350 €/kW	325 ..... 675 €/kW

1) dessicative and evaporative cooling

2) cooling amount to be assessed in primary energy terms, thermic respectively electrical energy. Calculation of the relation of produced amount of cold and used electrical or thermal energy. A number of 0.6-1.0 (second column) means that per kWh heat 0.6-1.0 kWh cold are provided.

3) coefficient of performance

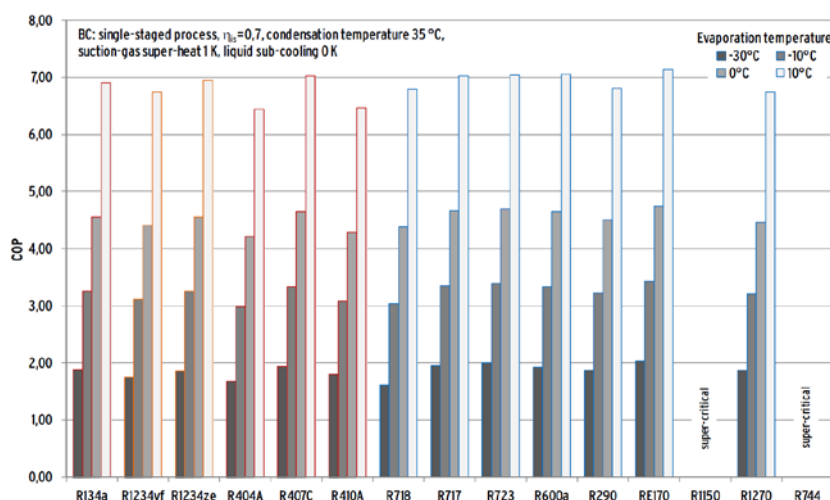
Source: adopted from Reitze 2012 and Kälte/Luft/Klimatechnik

The efficiency of the cooling system, especially the efficiency of cold production, depends on the type of refrigerant that it is used for the operation of the system and the temperature level required (see Figure 62 below). The example below is for a single-

staged thermodynamic cycle with a condensation temperature of 30°C and a turbine isentropic efficiency of 70%. For the displayed COP assumptions temperature of the sub-cooling liquid and vapor superheating are needed. The wide range of efficiencies observed for refrigerants for different temperature levels and refrigerant types is coupled to the saturation pressure in sub-critical processes in case the temperature is below the critical temperature of the refrigerant, which is the case for most of the refrigerants.

In transcritical processes, as observed with R744 (carbon dioxide) and R1150 (ethene) pressure in some EU countries becomes independent of temperature due to their low critical temperatures when compared to ambient conditions. However, pressure is adjusted by a controller. This has also an effect on the variability of efficiency of the cold production across countries. Due to the different refrigeration systems and thermodynamic modifications, for instance heat recovery systems or cooling demand requirements along the process, a wide range of COP values are possible. For energy efficiency the type of refrigerant has an influence on the electricity consumption for the mechanical drive of the compressor.

Figure 62: Coefficients of performance for single-staged processes of various refrigerants.



Source: UBA, 2015

For process cooling, there is a wide range of comparable energy efficiency potentials for the operation of these systems within the systems boundaries. These potentials include for example an appropriate temperature by a good regulatory compliance, improved thermal insulation of machines, cold rooms and cold bars, closed refrigerated counters, cooling recovery at "defrost processes" to cool other products.

On top of all efforts to improve energy efficiency in the refrigeration process relates to the avoidance of unnecessary cooling demand along processes and services. User profiles and partial load conditions should be taken into account when operating the equipment. Cooling could also be used to develop strategies for load shifting. During the optimization of cooling systems a holistic energy assessment of the whole refrigeration system should be carried out. Frequently air-conducting lines in the factories are not sufficiently insulated or in periods without cooling demand not disconnected (e.g. at weekends).

The coefficient of performance of refrigeration systems depends largely on the type of

capacitor or condenser used. Air-cooled compressor chillers generally have a lower performance figure ( $\varepsilon \approx 2,5$ ) than refrigeration systems with water cooling ( $\varepsilon \approx 3,5$ ) (Dengler et al., 2012).

Further possibilities include the replacement of single-stage cooling systems through two-phase systems and variable-speed compressor. The cooling unit should be operated at high cold water temperatures, as the need for driving energy is critically dependent on the difference between the generated cold water temperature and the temperature of the re-cooling. Per degree of temperature increase, the cooling capacity increases, according to an expert up to 8%.

The re-cooling system used is of central importance, since it is normally located next to the pumps being the largest consumers of electrical energy. The performance of the entire system is thus significantly affected. Re-cooling via installation near water fountain or ground probes is more efficient than the mostly wet heat exchange in open and closed cooling towers or dry re-cooling, which can be improved by spraying with water. Through heat recovery of the cooling system - according to „Radgen (2008)“ - at least 45% of cooling energy with little technical effort for the heating up of water could be used up to 45 ° C. In case of using compression machines or turbo machines for the cooling production, the use of waste heat of the compressor is always often a chance to fuel each other to reduce the process or heating fuel demand.

The use of cold storage – usually short-term capacities– should also be available in a number of subsectors of the tertiary sector for energy efficiency in refrigeration applications contribute (BINE Information Service, 2006; MVV ENERGIE AG, 2009). This ice storage can be applied in processes or storage as the normal temperature (0-15 ° C), which are just above the freezing temperature. Cooling applications, which can be in the negative temperature range, are not powered by ice storage (GREIN et al., 2009).

Ultimately the cooling demand can be served through the use of ice storage load peaks of cooling demand and thereby limit the installed cooling capacity (Radgen, 2008). Displacement of the cooling device system operation during the night time is possible under certain circumstances. At the same time the maximum cooling capacity can be increased, even if the maximum electric power is completely used (radgen, 2008).

As the above points can be seen in the commercial cooling technique high savings in money, energy and CO<sub>2</sub> emissions by regular maintenance or by use of today's technology are still possible. Different type of policy bundles exist and are developed across Europe to create different type of incentives for energy efficiency in the cooling sector. A summary of efficiency potentials in Europe is shown in the table below.

Table 50: Overview of energy efficiency options for process cooling.

Energy Efficiency Options	Practicability in %	Mean Technical Efficiency Potential in %	Total Efficiency Potential in % <sup>1</sup>
Electrical Regulated Pumps	60%	10%	6%
Speed-Controlled Compressors and Fans	40%	10%	6%
Improved Compressors/Chillers	40%	5%	2%
Systems for Optimisation	80%	10%	8%
Improved Industrial Process and Control	50%	10%	5%
Improved Insulation	50%	10%	5%
Reduction of the Cooling Load	30%	5%	2%
Regular Cleaning and Service	50%	8%	4%
Multicompressor Systems instead Individual Systems	10%	10%	1%
Multi-level Compressor and Sorption Processes	50%	15%	8%
Efficient Equipment/Illumination in Cold Storage Rooms	100%	2%	2%
High Efficiency Engines for Fans on Vaporizer respectively Condenser	100%	10%	8%
High Efficiency Engines for Fans on Vaporizer respectively Condenser	100%	5%	2%
Controlling of the Concentration Final Pressure at the Compressor	80%	15%	10%
Defrosting Controlling	80%	5%	3%
Total Potential (non-cumulative)	-	-	40-60%

1: The total efficiency potential takes the overlap of the effects of the single energy efficiency options into account.

Source: Reitze 2012

Technology providers and supply leaders focus on three main areas for energy efficiency improvement including the further development of the compressor in terms of volume capacity and speed (higher cooling capacities), the production of low GWP refrigerants or the switch to natural refrigerants and the increase in full and more importantly partial load efficiency and user-friendliness in different products and services.

### Cost structures

The total costs of a refrigeration system is composed by the investment (acquisition, transport, assembly, operation start), operational costs taking into account the major inputs such as refrigerants, electricity, water as well as maintenance costs (inspections, reparations, etc.). The cost of disposal after a substitution takes place also takes part of the formula.

Investment data is well distributed among several European and foreign producers

and besides the efforts of compilation of data for the EcoDesign Directive, IREES have also collected individual information for specific examples. This was also complemented by interviews with cooling experts. Using this information for compression cooling systems, average prices can be calculated for the EU28 as a function of cooling capacity. To take price differences among Member States into account, differentiated price levels are derived using information on the comparative price levels for machinery and equipment provided in Eurostat (2015a).

Investment costs vary due to different influencing factors including taylor made solutions as turnkey projects including the different shares for manufacturing, distribution, assembly, commissioning, warranties & insurances. The specific investment values are based on the study integrated heating and cooling strategy for Germany as well as more recent studies on sustainable cooling from the federal environmental agency. (Dengler et al., 2011, UBA, 2015)

The specific investment data is provided for the year 2012 with the German inflation rate and adjusted to 2013.

Compressor cooling is a mature technology and cost learning and decrease is not expected for the coming years. Maintenance costs can be high in cooling systems (above 15% of investment costs for both compression and absorption cooling plants). The technical lifetime of cooling systems in industry can reach at least 20 years and in the services sectors is 15 years.

Table 51: Specific investment costs in €/kW<sub>el</sub> of industrial cooling systems engines, adjusted to 2013 and extrapolated to the other Member States.

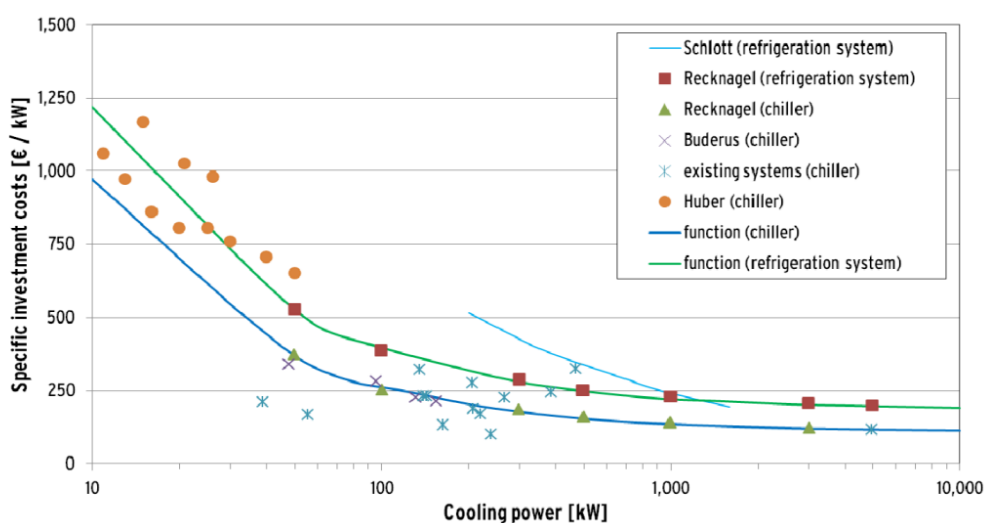
	<25 kW <sub>el</sub>	50 kW <sub>el</sub>	250 kW <sub>el</sub>	1000 kW <sub>el</sub>	4999 kW <sub>el</sub>	25000 kW <sub>el</sub>
<b>Austria</b>	776	555	311	237	205	199
<b>Belgium</b>	785	562	315	239	207	201
<b>Bulgaria</b>	663	474	266	202	175	170
<b>Croatia</b>	711	509	285	217	188	182
<b>Cyprus</b>	744	533	299	227	196	191
<b>Czech Republic</b>	692	495	278	211	183	177
<b>Denmark</b>	909	651	365	277	240	233
<b>Estonia</b>	701	502	281	214	185	180
<b>Finland</b>	859	615	345	262	227	220
<b>France</b>	734	526	295	224	194	188
<b>Germany</b>	734	525	295	224	194	188
<b>Greece</b>	800	572	321	244	211	205
<b>Hungary</b>	668	478	268	204	176	171
<b>Ireland</b>	783	560	314	239	206	200
<b>Italy</b>	743	532	298	227	196	190
<b>Latvia</b>	741	530	298	226	196	190
<b>Lithuania</b>	697	499	280	212	184	178
<b>Luxembourg</b>	758	543	304	231	200	194
<b>Malta</b>	767	549	308	234	202	196
<b>Netherlands</b>	745	533	299	227	196	191

	<25 kW <sub>el</sub>	50 kW <sub>el</sub>	250 kW <sub>el</sub>	1000 kW <sub>el</sub>	4999 kW <sub>el</sub>	25000 kW <sub>el</sub>
Poland	674	483	271	206	178	173
Portugal	779	557	313	237	205	199
Romania	844	604	339	257	223	216
Slovakia	753	539	302	230	199	193
Slovenia	690	494	277	210	182	177
Spain	717	513	288	218	189	183
Sweden	818	586	328	249	216	209
United Kingdom	718	514	288	219	189	184

Source: IREES, own calculations

Industrial and commercial chillers have lower investments and O&M costs as refrigeration systems depending on the compression type systems and the amount of parts of the system. In summary small capacities (10kW) can reach over 1200 €/kW for refrigeration systems while ca. 1000 €/kW for the chiller function. This data (table 49) is only available for EU-28, a similar development as for Germany or Scandinavia is expected for Switzerland, Norway and Iceland. A factor 10 increase in capacity means 75% decrease in specific investment costs for chillers (250€/kW) as for refrigeration systems around 350-400 €/kW is obtained. The scale effect towards larger systems means specific investment costs below 250€/kW for both types.

Figure 63: Specific investment costs in €/kW cooling power capacity in Europe for different type of chillers and refrigeration systems.



Source: UBA, 2015

### 3.6.3 Technology stock distribution

Data on technology stock is rather limited and is partially found in EcoDesign preparatory studies. Furthermore organisations were contacted in order to explore the possibility of available information, but the response rate with this information was low. In order to estimate installed capacities and quantities for process and space cooling in industry and services sectors, model results from FORECAST model in WP1 were used to fill the data gaps with additional calculations. From the obtained energy demand,

estimations of the ordinary capacity and with the typically full load hours the number of units were estimated. No information was found on a possible distribution of the capacity in different capacity sizes. The calculation of capacity and number of units is based on assumptions done on average capacity sizes for cooling systems and assumed Full Load hours. Depending on the temperature of the different countries different full load hours have been assumed. In order to validate assumptions for the calculation of the technology stock (e.g. full load hours and average installed capacity) interviews with organizations and experts were conducted. A full list of the contacted organisations is provided in Table 52.

Table 52: Overview of contacted organizations with respect to process and space cooling data.

<b>EU</b>	
EVIA	European Ventilation Industry Association
EHPA	European Heat Pump Association
ECSLA	European Cold Storage and Logistics Association
PCF	Perishable Center GmbH & Co. Betriebs KG
Friopuerto	Friopuerto Investment, S.L.
Eurofrigo	Eurofrigo B.V.
SETIS	Strategic Energy Techn. Inf. Systems
EERA	European Energy Research Alliance
EARTO	European Ass of Research and Technology Organisations
AREA	Air conditioning and Refrigeration European Association - AREA aisbl
AiCARR	AiCARR Associazione Italiana Condizionamento dell'Aria Riscaldamento e Refrigerazione
<b>Hungary</b>	
HKVSZ	Hűtő- és Klimatechnikai Vállalkozások Hungarian Climate Technology
<b>Austria</b>	
ÖKKV	Öst. Kälte- und Klimatechnischer Verband – Association for cooling and climate technology
<b>Switzerland</b>	
SVK	Schweizerischer Verein für Kältetechnik – Swiss association for cooling technology
<b>Germany</b>	
ZVEI	Zentralverband Elektrotechnik- und Elektronikindustrie – Central association for electro-technique and electrical industry
UBA	Umweltbundesamt - Federal Environmental Agency
DSR-KKW	Deutscher Sachverständigen Rat Kälte Klima Wärmepumpe
VDKF	Vb dt Kälte Klima Fachbereiche – German Association for cooling and climate
FGK	Fachverband Gebäude Klima – Technical association for cooling in buildings
KKP	Kälte Klima Portal (Experteninformationen zur Kälte-Klimatechnik) - Climate-cooling Portal
FKT	Forschungsrat Kältetechnik – Research council for cooling technologies
VHKK	Historische Kälte Klimatechnik - Historical cooling and climate technique
VDKL	Vb dt Kühllhäuser und Kühllogistikunternehmen – German association of cooling storage and cooling logistic companies
GFK	Gesellschaft für Konsumforschung – Society for consumption research
EHI	Marktforschungsinstitut, Retail Market Research Institute
EID	Energieinformationsdienst – Energy Information Service
GFKK	Gesellschaft für Kältetechnik-Klimatechnik mbH – Society for cooling and climate Technology

Source: IREES

The distribution of the stock of cooling systems for both compression and absorption refrigeration is not available for process cooling in industry neither at EU nor national



levels. Compression refrigeration aggregates the different compression technologies and refrigeration systems based on refrigeration. The results presented here rely on assumptions on the operation of these cooling systems with full load hours as well as average installed capacities differentiated for each industrial branch or commercial sub-sectors.

Table 53: Estimated installed capacity and number of units for EU-28 for compression refrigeration systems.

	Installed capacities (GW)		Number of units (units)	
	Industry	Services	Industry	Services
Compression Refrigeration (all ranges)	37	82	75,000	19 million

Source: own calculations IREES

The stock of refrigeration systems is a dynamic element and its development depends on the assumed cooling demand and the lifetime of existing and new systems. In industry the assumed lifetime for calculations is 20 years, however the lifetime of these systems depends also on the size of the installed devices. The Ecodesign stock figures for commercial refrigeration representing mainly the services sector cooling processes indicated a total stock of 14.24 Million units for Europe in 2004 and 2006 with annual sales that amount ca. 1.65 Million units in 2006-2007. The stock dynamics indicate partially the investment in new cooling systems but also the replacement of existing systems in the sales. *For services the bottom up electricity consumption values (with different assumptions for full load hours and average cooling plant sizes) result in a larger stock in 2013 which amounts roughly to 19 million units in the services sector.*

The emergence of absorption cooling is present for certain European countries with cooling degree days below 500 days and heating degree days from 1500 to 3000 days. This could range from central Europe (south Germany, Eastern France, North of Spain followed by north of Italy until north Romania). The local conditions how the heat is obtain to absorb and produce cooling depends on very specific local aspects (price for heating source, solar thermal production, etc.). However the authors did not find condensed statistics for the characterization of a stock for this emerging technology. Currently there are demonstration activities in countries where heat is available in form of district heating, waste heat from industry or from renewable solar thermal applications. A possible range of absorption cooling in EU can vary between 1% to maximum 5% of the electricity demand for cooling of a country, is assumed by the authors. The plausibility of this assumption remains constained.

Table 54: Stock of products covered in the Lot 12 EuP for EU-25 and overview of sales.

Product Category	Stock (units)
Remote refrigerated display cabinets (for 2006)	2.150.000
Plug in refrigerated display cabinets- supermarket segment	1.900.000
Beverage coolers – Food and beverage segment	6.320.000
Ice cream freezers – food and beverage segment	2.710.000
Cold vending machines (year 2004)	1.160.000

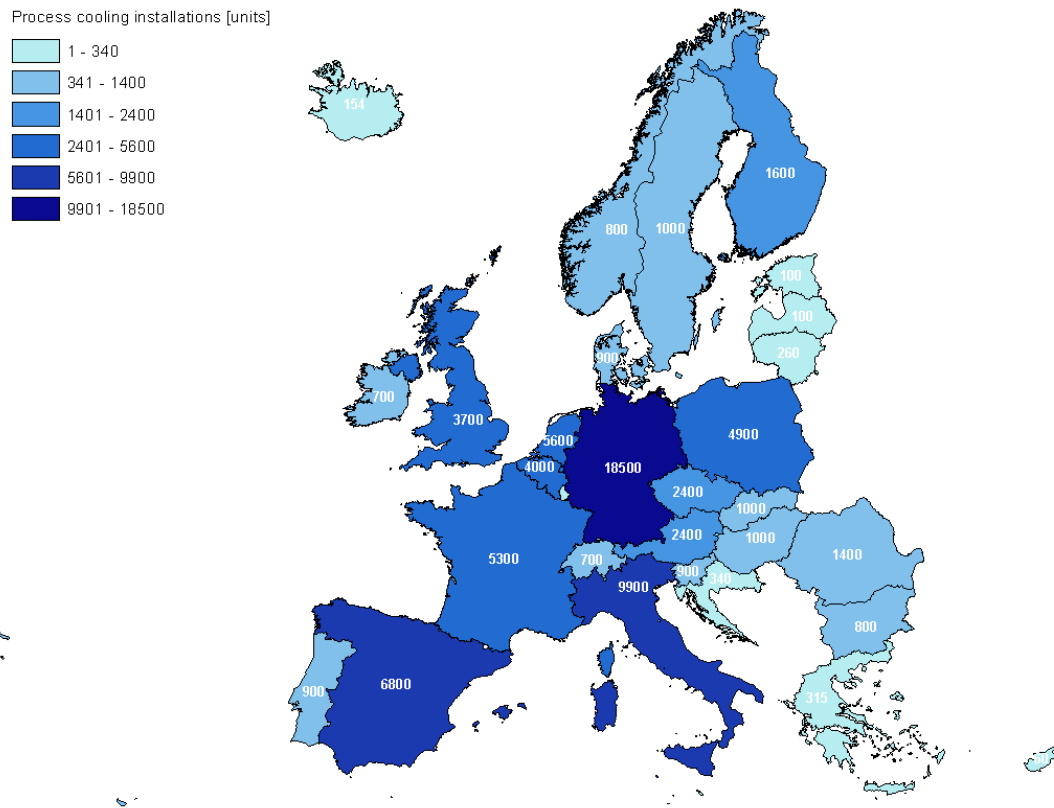
Product Category	Sales (units)
Remote refrigerated display cabinets (for 2006)	240.000
Plug in refrigerated display cabinets- supermarket segment	150.000
Beverage coolers – Food and beverage segment	790.000
Ice cream freezers – food and beverage segment	340.000
Cold vending machines (year 2004)	120.000

Source: European Commission 2007, European Commission 2011

As an example of the results obtained, the total stock of compression cooling for process cooling in industry in the EU28 needs to be broken down for different EU countries. The main fuel for the production of cooling in this case is electricity. The allocation at country level considers information from various European statistics using a combination of price level indices for machinery and equipment (Eurostat 2015a). The results of this are illustrated in Figure 64. According to this estimate, 75% of the total cooling systems stock (about 73,000 cooling systems) is located in 7 countries including Germany, France, Italy, the Netherlands, Poland, UK and Spain.

In the services sector approximately 75% of the total cooling system stock for process cooling (ca. 19 Million systems) can be found in Germany, Italy, France, Spain, Poland, the Netherlands and in the UK.

Figure 64: Process cooling stock in industry in the EU



Source: own calculations, IREES

## 4 Cross-sectoral

### 4.1 District heating and cooling

#### 4.1.1 Description of data used

##### Description of method

A combination of four different approaches was used to access the relevant data:

1. Online desk research of publicly available data. Statistics regarding the district heating/cooling sector are often collected at national level by associations of district heating operators, statistical offices or other national authorities.
2. Direct contact with the above mentioned associations, in order to access data not publicly available. To facilitate communication as well as data transfer, a questionnaire in template form was developed and sent to the relevant contacts. This opportunity was also used to gather data relevant for 'WP1 – District Heating and Cooling'.
3. Purchase of reports from the relevant European/international associations. In this regard, one of the main data sources was 'District heating and cooling, Country by Country, 2015 Survey' by Euroheat & Power (Euroheat & Power, 2015).
4. Contact to international organizations which might have useful data (e.g. European Geothermal Energy Council).

##### Evaluation of quality/availability of data

The availability of data and its level of detail depend strongly on the country as countries with a more developed or growing district heating sector are generally able to provide in-depth analyses and reports on this topic. No data or only partial data could be retrieved for the UK, Belgium, Luxembourg, Portugal and Greece.

The data regarding total installed district heat/cool capacities and trench length are published by EHP and/or by national district heating associations for a number of countries. However, information related to the production technology is normally not publicly available and often not even accessible to the district heating associations themselves. As a result, this kind of data is available only for a number of countries. The plant database published by Solar District Heating (SDH) was integrated into our database and the European Geothermal Energy Council (EGEC) played a key role in providing data concerning this technology.

Since district cooling is not widespread, there is only limited information (mainly final consumption and installed cooling capacity) about this technology.

##### Platts database

The UDI World Electric Power Plants Database is a global inventory of electric power generating units. This database was acquired to improve the quality of the data describing the CHP portfolio of power plants (CCGT, steam turbines, gas turbines and IC engines) within the district heating sector. However, several difficulties were encountered when trying to identify the district heating plants that resulted in the decision not to use the extracted data. These included:

- The absence of indicators allowing clear identification of plants operating in the district heating sector. Therefore, some proxy indicators had to be used, leading to a significant degree of approximation.

- The absence of data related to the installed thermal capacity of CHP plants.
- Partial mismatches with data obtained from other sources.

Several different approaches were taken to try and find better proxies, but the quality of the data extracted was judged insufficient.

#### **Data gaps**

In its report, EHP provides mainly data for 2011 and 2013. Since 2012 was chosen as the baseline year in this project, it was necessary to derive the relevant values (concerning trench length or installed district heating thermal capacity) for 2012 through interpolation. When appropriate, data gaps were filled using correlations based on time series or other reference countries.

If these methods were applied, this was indicated by marking the data with the letter 'a' for 'ad hoc calculation' or with 'x' for 'interpolation/extrapolation' in the 'Notes & Methodology' column in Table 57.

#### 4.1.2 Scope and description of technology

##### District heating

District heating can be described as a system in which heat is produced centrally by one or more larger units and then transported through a network of pipes to the final user. In Europe, most district heat is used in the residential sector and more specifically for domestic hot water (DHW) preparation and space heating.

A wide range of energy inputs can be used to supply district heating systems, such as heat from CHP units (e.g. steam turbines, gas turbines, IC engines, waste-to-energy plants), heat-only plants (e.g. boilers, geothermal, heat pumps, solar thermal) or waste heat from industrial processes.

The interface between the district primary network and the users' building network is the substation, which basically consists of a heat exchanger equipped with various regulating, safety and measurement devices. The substations, in fact, also represent the digital connections for measuring the amount of heating/cooling delivered.

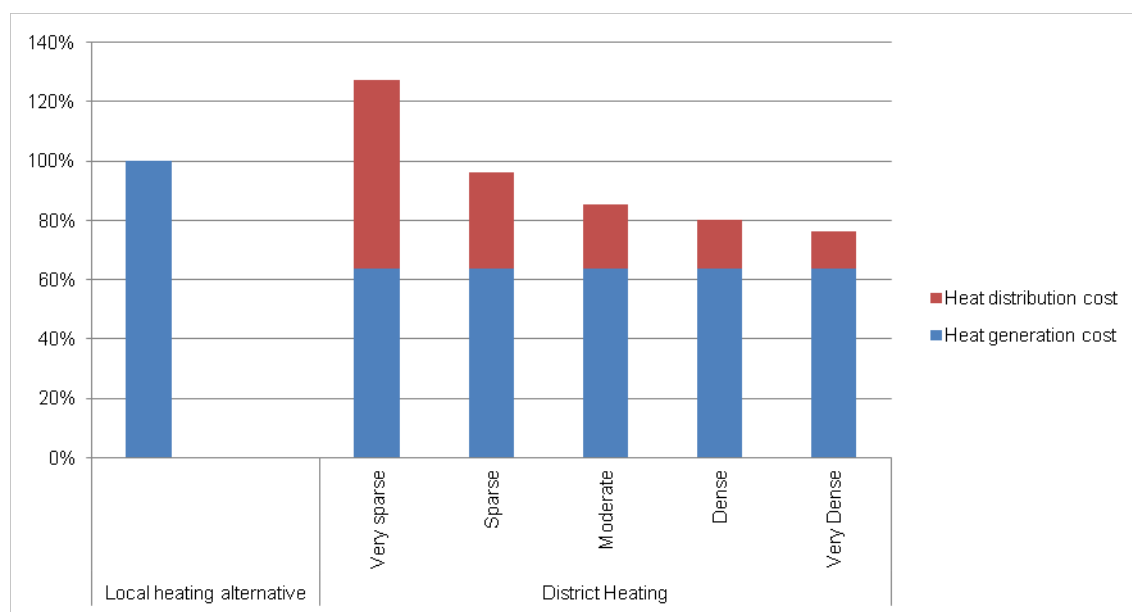
A district heating scheme can be divided into three parts, which are closely interconnected: the central heat production units, the heat distribution network and the customer installations. The system can be designed around consumers' needs, which set the dimensioning parameters for the distribution network and the production plants, or the other way round. Aggregating heating/cooling needs allows the implementation of more efficient technologies and optimized dimensioning, leading to energy savings and lower CO<sub>2</sub> emissions.

The main drawbacks of district heating and cooling systems include their relatively high running costs, investment costs and losses in the distribution system. Heat losses depend on many factors such as the level of insulation, size and shape of the pipes, temperature difference to the ambient temperature, and mass flow rate. Heat losses up to 30% may occur in distribution networks with low consumer energy density, while in energy dense areas with pre-insulated pipes, the losses may be less than 3% (Danfoss 2016)- The heating book).

Denmark is one of the countries where transportation losses are relatively high, because the district heating network there is spread across areas with low heat density (ENS, 2015). Typical network losses here are in the range of 15-20% (Cowi et al., 2012).

The cost of heat distribution depends on the heat-density of the area served by the district heating networks and influences its competitiveness with decentralized heat production as shown in Figure 65 (Persson, Urban, 2015).

Figure 65: General comparison of total costs of the consumer for local heat generation and district heating, subdivided into heat distribution cost/generation cost depending on grid density (schematic, cost for on-site heating alternative set to 100%) (Persson, Urban, 2015).



The age of the system also plays a substantial role because older district heating schemes, e.g. in Eastern Europe, are generally characterized by low efficiency of heat production, high heat production costs, high transmission losses, oversized networks, and lack of heat production and utilization control (Mikulandrić et al., 2014). Furthermore such systems tend to rely almost exclusively on fossil fuels. Indeed, in Eastern European countries, the share of fossil fuels represents between 80% and 100% of the energy supply for district heating. In Romania, insufficient financial resources for the operation, maintenance, rehabilitation and modernization of district heating systems have resulted in a deficient and uncompetitive structure, which is very inefficient (heat losses between 35 and 77%) and paid for by both final consumers and – to a certain amount – the social welfare system (Ibp Inc., 2015).

The district heating system design has been evolving over the years and better solutions are constantly being explored. The first generation of district heating systems that used steam as the energy carrier are now outdated, because of safety reasons and high distribution losses, but some networks still operate with this technology. The second generation, introduced in the 1930s, used pressurized hot water as the heat carrier with temperatures typically above 100°C, while the third generation (which emerged in the 1970s) employed pressurized water with temperatures lower than 100°C. It is evident that one of the aims of the progressive development of district heating schemes is to reduce distribution temperatures.

Research is currently being carried out on the fourth generation of district heating. The main goal is to create a coherent technological and institutional system, able to supply heat to low-energy buildings with low grid losses by integrating low-temperature heat sources (4DH Research Centre). Low-temperature district heating has been defined as having a supply temperature of 50°C and a return temperature of 25-30°C, but the concept refers not only to temperature levels, but to a comprehensive optimization of the system, which includes a better design of the network (e.g. use of twin-pipes, small service pipes and high insulation). Another approach is cold district heating, in

which even lower supply (and return) temperatures not only lead to a further decrease of heat losses in the heat grid but also enhance the usability of lower temperature heat sources such as waste heat. From cold district heating grids the useful heat is supplied by heat pumps.

### **District cooling**

In a district cooling network, the water is cooled down to temperatures between 6 and 7°C (a mixture of ice and water at 0°C (ice-slurry) is also used sometimes) and distributed to consumers through an underground network of pipes; the warmed-up water (temperature between 12°C and 17°C) is then returned to the central production facility through the return pipe (ECOHEATCOOL, 2006). In the European countries with district cooling, the chilled water is mainly obtained using absorption and compression chillers. Reversible, ground-coupled heat pumps and free cooling play a marginal role, although there are a few exceptions such as Finland, where heat pumps and free cooling are widespread in the district cooling supply.

It is also possible to take advantage of the district heating network and generate cold water at the consumption site using absorption chillers. This combination of district heating and cooling (DHC) is particularly advantageous in summer, when the heat load is lower. According to AIRU, in Italy in 2012, more than half of the district cooling capacity was installed at users' locations. However, even though the cost of dedicated transport networks is avoided, the installed machines are normally single-stage absorption chillers, characterized by low Coefficients of performance (COP of 0.6-0.65) (AIRU, 2013).

Finally, the term trigeneration (or CHCP, combined heating, cooling and power) refers to the simultaneous production of power, heat and chilled water with the addition of absorption/compression chillers. If the trigeneration plant is connected to a district network, it is normally a four-pipe distribution system, as both the warm and cold energy carriers are generated centrally. One example is the district energy system of Parque das Nações in Lisbon, which was built in 1997 and now delivers cool water (4°C) and hot water through a four-pipe 21 km long distribution system (Climaespço, 2012).



### 4.1.3 Technology characterisation

This section describes the main technologies used to supply district heating and cooling. For more technical details, please refer to the chapters:

- Large heat boilers chapter 2.1,
- Direct electric heating chapter 2.2,
- Internal combustion engines (CHP-IC) chapter 2.3,
- Heat pumps chapter 2.4,
- Biomass boiler chapter 2.5,
- Solar thermal in district heating chapter 2.6,
- Steam and gas turbine CHP, as well as combined cycle CHP chapter 3.2
- Cooling technologies chapters 2.7 and 3.6.

Table 55 and Table 56 provide an overview of the performance and investment costs of these technologies. The investment costs are all in euros (€), 2014 price-level and harmonized to the EU 28 Price Level Index (PLI EU 28 = 100).

More detailed information is provided in the Excel worksheet attached to this report (e.g. division for capacity classes and investment costs by country).

#### CHP Technologies

Steam turbines, gas turbines, gas turbines combined cycle, gas fuelled internal combustion engines and waste-to-energy plants are typical cogeneration technologies to produce heat and power simultaneously in order to achieve very high overall energy transformation efficiencies.

A large variety of fuels like natural gas, coal, biomass and others (e.g. uranium) can be used in a boiler or reactor to produce steam which then drives a steam turbine to produce power. Steam turbines, whose capacity can reach several hundred MWs, operate on a thermodynamic cycle known as the Rankine Cycle and are widely used for combined heat and power applications in Europe. Steam turbines used for CHP can be classified into two main types: back-pressure and extraction. A back-pressure turbine delivers some or all of its steam flow at conditions close to the process heat requirements. The lower pressure levels are normally used to supply district heating systems, while higher pressures are used for industrial processes. In an extraction turbine, part of the steam flow is extracted at an intermediate pressure and the rest is expanded in a low-pressure stage (Darrow et al., 2015).

Gas turbines are available in sizes from 500 kW<sub>el</sub> to over 300 MW<sub>el</sub> for both power-only generation and combined heat and power systems. The exhaust gas contains all the recovered heat which is extracted in an exhaust gas boiler to produce hot water (for low-temperature needs) or steam. Typical fuels are natural gas and light oil, but some models can also be powered with LPG, biogas etc. Their technical lifetime is around 25 years for medium to large models, but shorter for small turbines (Cowi et al. b, 2012; Darrow et al., 2015). In a gas turbine combined cycle (or CCGT), the exhaust gas from a gas turbine enters a heat recovery boiler, which produces steam used to drive a steam turbine. Similar to CHP steam turbine plants, the system can be designed and operated as a back-pressure steam turbine or extraction steam turbine and the heat extracted can be used for industrial processes or supplied to the district heating network. Units below 20 MW<sub>el</sub> are rare, as the economies of scale for CCGT are substantial and electrical efficiencies increase with size. The electrical efficiency

depends, besides the technical characteristics, on the district heating forward temperature (Lako, 2010; Cowi et al. b, 2012).

Internal combustion engines are a widespread and established technology used for a number of applications including the heat supply to district heating networks. In internal combustion engines, it is possible to retrieve useful heat from the exhaust gas and the coolant jacket, while smaller amounts can be recovered from the lube oil cooler and from the intercooler/ aftercooler. However, only the exhaust gas reaches temperatures high enough to produce steam so that the amount of heat recovered from the engine is reduced if no hot water is needed (Darrow et al., 2015). The typical capacity of internal combustion engines is between 0.005 and 8 MWeI per engine and their technical lifetime is 20-25 years (some units have even smaller electrical capacities of 0.001 MWeI). Their efficiency can be enhanced with flue gas condensation, e.g. in the case of district heating systems with low return temperatures (Cowi et al. b, 2012).

Waste-to-energy plants are normally designed for the main purpose of waste incineration and energy production can be considered a useful by-product. The major components are a waste reception area, a feeding system, a grate-fired furnace connected to a boiler, and an extensive system to clean the flue gas and to handle residues. If the process is combined with electricity production, a back-pressure steam turbine is used. Excess heat is processed in a heat exchanger to produce hot or warm water which is then fed into the district heating network. The low electrical efficiency (around 20-25%) is due to the corrosive nature of the flue gas, which limits the permissible steam pressure and temperature to around 40-65 bar and 400-425°C, respectively. If the water vapour is condensed, the plant's overall efficiency is close to 100% (related to the calorific value) (Garcia N. et al., 2012; Cowi et al. b, 2012). From 2020, it is assumed that the selective catalytic reduction (SCR)-process will be applied to reduce NOx, which will result in increased investment/O&M costs and a slight reduction of the electrical and overall efficiency (Cowi et al. b, 2012).

## **Boilers**

Boilers have been used to supply district heating systems for more than three decades, but nowadays they are mostly used for peak-load or back-up capacity. The efficiency of boilers ranges between 86 to 100% (Wenzel et al., 2010.) and they can be equipped with condensers to improve their performance, even though back-up systems do not normally implement condensers because of the additional costs involved. The typical capacities of gas boilers for district heating applications are between 0.5 and 20 MWth (Garcia N. et al., 2012). Biomass boilers are generally fired with wood-chips from forestry or the wood industry, wood pellets or straw. If the moisture content of the fuel is above 30-35%, it is possible to use flue gas condensation and the thermal efficiencies exceed 100%. Flue gas condensation should not be applied to small plants because of O&M costs. Wood pellets are not attractive for larger plants above 1-2 MWth, since other fuels are then much cheaper (Cowi et al. b, 2012).

Electric boilers are able to produce hot water directly from electricity using either an electrical resistance (for smaller applications up to 1-2 MWth) or an electrode system (larger than a few MWs up to 25 MWth). The energetic efficiency of both types of boiler is 99%. Electric boilers are very dependable, easy to maintain and their output can be controlled to a large extent. Their operating costs depend heavily on electricity prices (Cowi et al. b, 2012).

As shown in Table 55 and Table 56, no significant variation in performance or investment costs is expected for boilers in the near future.

### **Geothermal district heating**

Geothermal District Heating (GeoDH) is based on the extraction of heat from underground water reservoirs that is passed through a heat exchanger and used in a district heating network. The size of the systems varies widely, but most geothermal district heating plants have a capacity between 10 and 15 MWth. In many cases, large heat pumps are used to extract heat from reservoirs closer to the surface (800-3000 m depth). Either electrical heat pumps or absorption heat pumps are used, the latter driven by the steam produced in district heating plants. In this case, the temperature of the re-injected water is around 8°C and the supply temperature of the district heating is 80°C during the winter months.

Geothermal district heating is characterized by high initial costs, but the cost of the heat can be decreased by drilling multiple boreholes at the same site. The geothermal energy should be used to cover the base load, because of economic reasons (Garcia N. et al., 2012; Cowi et al. b, 2012).

Considering the stock in 2012 in the countries analyzed, the average installed thermal capacity was 14 MWth for heat-only plants. Moreover, the direct use of geothermal heat for district heating is much more frequent than the extraction of heat from CHP units powered with geothermal sources. Iceland alone accounts for more than 60% of the installed district heating thermal capacity. The plants in Iceland are characterized by a higher average thermal capacity of around 56 MWth, for heat-only plants (own elaboration of (EGEC, 2013) and (EGEC, 2015) data).

### **Solar district heating**

Solar district heating systems consist of one or more solar collector fields integrated into a district network to supply heat to the connected residential and industrial users. The system needs an additional generation capacity to cover the heat demand in periods with insufficient sunshine or in the winter. This can be provided by heat-only boilers or by combined heat and power units. The solar district heating plants are classified as 'central' if the collectors deliver heat to a central main heating or 'distributed' if the collectors are connected to the district heating primary circuit. The system can be coupled with large scale heat storages (e.g. seasonal heat storages) or use the district heating network itself as storage (Garcia N. et al., 2012).

In Europe, the vast majority of solar district heating systems use flat plate collectors and only a few feature unglazed and vacuum tube collectors. Considering the stock in 2012, the average thermal capacity of the solar district heating plants in Europe was around 3 MWth and around 50% of them began operating after 2002. Denmark leads the application of solar district heating as it accounts for more than 50% of the total installed thermal capacity of solar district heating among SDH (Solar District Heating) member countries. However, solar thermal remains a marginal technology in the district heating supply sector, both in terms of the heat produced and the installed thermal capacity (own elaboration of (SDH) data).

### **District cooling: Absorption / compression chillers and free cooling**

Absorption chillers use a heat source (e.g. solar energy, waste heat) to provide the energy needed to drive the cooling process. In this way, the electrical power consumption is substantially reduced and the primary energy is used more efficiently. The coefficient of performance (COP) ranges between 0.5 and 0.8 for one-stage sorption (absorption or adsorption) chillers, between 1.1 and 1.4 for double-stage machines and up to 1.8 for triple-stage machines (Wiemken et al., 2013).

Compression chillers use electricity to power the cooling process. If absorption or adsorption chillers are used, compression machines can be added to the production mix

to guarantee outgoing temperatures and/or peak load. Furthermore, the compression machines are back-up machines ensuring the uninterrupted cold supply. The COP, calculated as the ratio of the delivered cooling to the electricity input, ranges between 1.8 and 4.2, with a higher performance for water-cooled chillers (Henning et al., 2012).

Free cooling is based on exploiting freely available cold water (e.g. oceans, lakes, rivers, aquifers) or using the outside air directly with dry cooling towers or as evaporative cooling in combination with wet cooling towers. The cold is transferred to the distribution network via heat exchangers and delivered to the customers. Such systems are normally employed when the distribution network has a limited length and the temperature of the cold source is low enough.

### **Heat pumps application in district heating / cooling**

Heat pumps are able to move heat from a low-temperature source (input heat) to heat sink at higher temperature (output heat). The input heat is normally drawn from the ambience, while the delivery temperature depends on the heat source temperature and the drive energy. Heat pumps can either be compression heat pumps, which consume electricity, or absorption-driven heat pumps, which use high-temperature heat to operate the process instead of electrical energy. The energy can come from different sources such as waste heat from industry processes, flue gas, renewables or natural gas etc. Heat pumps are normally available up to 3-5 MWth output, while larger heat pump systems typically consist of a number of heat pumps connected in parallel (Cowi et al. b, 2012). Similar to solar thermal, this technology makes only a marginal contribution to the district heating supply in most countries.

Heat pumps can be used for the simultaneous production of heating and cooling. In fact, the cold side of the heat pumps can be connected to the district cooling system to take advantage of the surplus cooling. As an example, the Katri Vala plant in Finland has an output of 90 MW of district heat heating and 60 MW of district cooling.

Table 55: Supply technology performance.

Technology	Total efficiency today, net	Electrical efficiency today, net	Total efficiency 2020, net	Electrical efficiency 2020, net	Total efficiency 2030, net	Electrical efficiency 2030, net
	[%]	[%]	[%]	[%]	[%]	[%]
Internal combustion engine (1)	88-96	40-48	88-96	43-50	88-96	43-50
Steam turbine, back pressure	90-106	25-40	90-103	25-43	90-103	25-45
Gas turbine	80-85	28-44	80-85	36-50	80-85	36-50
CCGT, back pressure	82-89	41-55	91	48-56	91	48-56
CCGT, steam extraction	88-92	50-53	85-91	54-58	86-94	55-60
Waste-to-energy (CHP) (2)	98	24	97	26	97	26
Waste-to-energy (non CHP)	86	-	86	-	87	-
Boiler, gas	95	-	95	-	96	-
Boiler, oil	86	-	86	-	87	-
Boiler, coal	90	-	90	-	91	-
Boiler, biomass	97	-	97	-	98	-
Boiler, electric	99	-	99	-	99	-
Solar thermal (3)	0.21	-	0.22	-	0.23	-
Heat pumps, large	3.76	-	3.81	-	3.90	-
Geothermal DH, direct use	96	-	96	-	97	-
Compression refrigerator (4)	1.8-4.2	-	n.a.	-	n.a.	-
Absorption refrigerator (5)	0.5-1.8	-	n.a.	-	n.a.	-
District heating network (6)	85	-	85 - 90	-	85 - 90	-

n.a. = not available

#### Notes

(1): Spark ignition engine, natural gas

(2): Waste treatment capacity 25-35 tonnes/hr

(3): Performance ratio provided: ratio useful energy to incident solar radiation, assumed solar irradiation: 1100 kWh/(m<sup>2</sup>a)

(4): COP<sub>el</sub>

(5): COP<sub>th</sub>

(6): Potential future improvements for the efficiency of district heating networks are estimated. Efficiency improvements are possible, if future building insulation standards allow lower supply temperatures. On the other hand, lower heat consumption can lead to higher relative losses of the distribution systems.

Sources: (Wenzel et al., 2010; Cowi et al., 2012; Cowi et al. b, 2012; Wiemken et al., 2013; Henning et al., 2012)

Table 56: Supply technology investment costs.

Technology	Nominal investment today	Nominal investment cost 2020	Nominal investment cost 2030
	[M€/MW]	[M€/MW]	[M€/MW]
Internal combustion engine (1)	1.06	1.06	1.06
Steam turbine, back pressure	1.72-4.35	1.72-3.80	1.68-3.80
Gas turbine (2)	0.55-1.01	0.51-1.01	0.51-1.01
CCGT, back pressure	1.14	1.23	1.23
CCGT, steam extraction	0.74	0.69	0.68
Waste-to-energy (CHP) (3)	7.18	7.18	7.18
Waste-to-energy (non CHP)	0.06	0.06	0.06
Boiler, gas	0.04-0.07	0.04-0.07	0.04-0.07
Boiler, oil	0.04-0.07	0.04-0.07	0.04-0.07
Boiler, coal	0.03-0.04	0.03-0.04	0.03-0.04
Boiler, biomass	0.47	0.43	0.42
Boiler, electric	0.23	0.23	0.23
Solar thermal (4)	0.66	0.44	0.39
Heat pumps, large	0.88	0.73	0.67
Geothermal DH, direct use	0.65	0.62	0.60
Compression refrigerator (5)	0,11 - 0,23	n.a.	n.a.
Absorption refrigerator (5)	0.03 - 0,18	n.a.	n.a.
District heating network	0.56	0.56	0.56

n.a. = not available

#### Notes

For electricity generating technologies (incl. CHP) MW is referring to MWeI

(1): Spark ignition engine, natural gas

(2): Excluded mini-turbines (< 5 MW). Large industrial turbine (lower efficiencies) investment costs are typically 0.36-0.54 M€/MW

(3): Waste treatment capacity 25-35 tonnes/hr. Total costs include the ones related to waste treatment and heat production

(4): Derived considering a ratio of 0.7 kWh/m<sup>2</sup>. Including seasonal storage. Solar fraction: 80% (DHW and space heating)

(5): Specific investment cost depend on capacity and temperature levels, cost range referring to 1 MW to 10 MW

Sources: own elaboration of data from (Lucas et al., 2002; Wenzel et al., 2010; Cowi et al. b, 2012)

#### 4.1.4 Technology stock distribution

The installed thermal capacity and trench length for district heating are presented in Figure 66. The countries with higher installed district heating thermal capacity are Poland and Germany, which are also the countries with the highest district heat sales, as shown in WP1. The heat transport losses, which range between 8% and 21% in the countries with available data, partly reflect the age of the systems, but are also influenced by the average size of the network, the energy-density of the served areas and the distance between the generating plants and the delivery area.

The share of CHP in district heating generation is very country-specific, from 2% in Norway with only one CHP plant serving district heating networks (NFV, 2015) to Romania, Germany and Croatia, where a substantial share of the heat generated

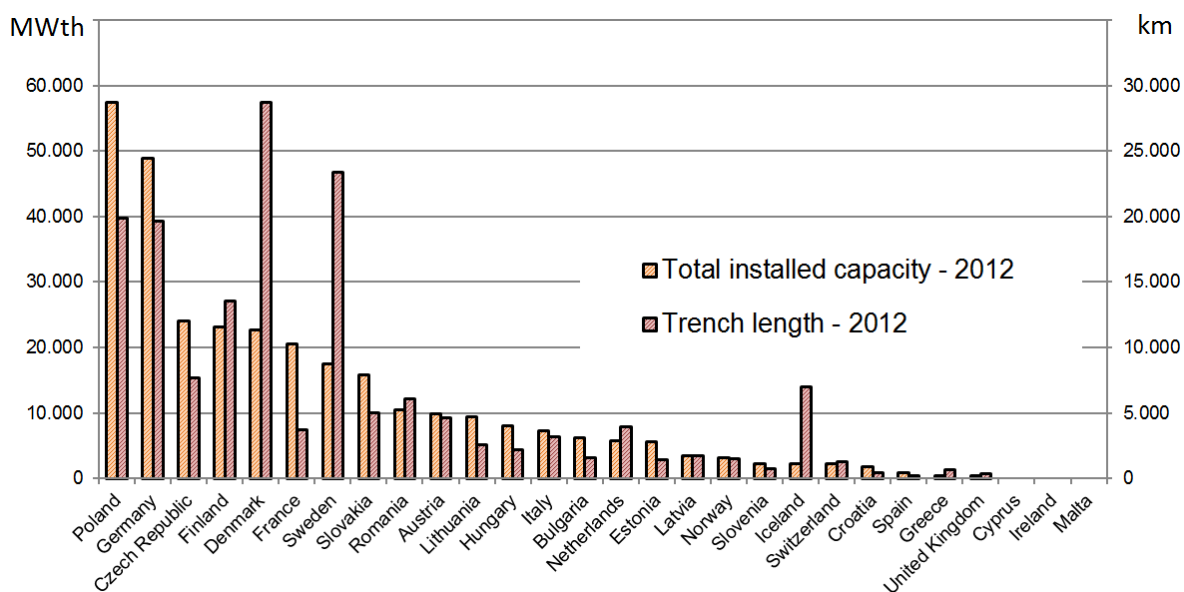
comes from district heating plants.

Back-pressure or steam extraction steam turbines play a prominent role in district heat generation, while solar thermal and heat pumps are still marginal. Denmark leads the application of solar district heating as it accounts for more than 50% of the total installed thermal capacity of solar district heating among SDH (Solar District Heating) member countries. With the exception of Switzerland, nuclear district heating is limited to Eastern European countries like Slovakia, Czech Republic, Romania and Hungary. Even in these countries, its overall contribution to the district heat supply is minimal. The direct use of geothermal heat for district heating is much more frequent than the extraction of heat from CHP units powered with geothermal sources. Iceland alone accounts for more than 60% of the installed geothermal district heating thermal capacity.

In the district cooling sector, most of the installed cooling capacity is from absorption and compression chillers, while free cooling and heat pumps are not being used in the vast majority of the analysed countries. A notable exception is Finland, where free cooling and heat pumps account for most of the total cooling capacity in district cooling.

It can be noted that district heating is much more developed and widespread than district cooling both in terms of trench length and installed capacity.

Figure 66: District heating - Installed thermal capacity and trench length.



Source: see Table 55 (only countries with available data presented).

Table 57: District heating and cooling characterisation.

	District heating				District cooling			Notes & Methodology						
	Total installed thermal capacity in 2012 [1]	Trench length in 2012 [2]	Average transport losses in 2012 [3]	Share of CHP in DH generation in 2013 [4]	Share of CHP in electricity generation in 2012 [5]	Total installed cooling capacity in 2012 [6]	Trench length in 2012 [7]	[1]	[2]	[3]	[4]	[5]	[6]	[7]
	[MW]	[km]	[%]	[%]	[%]	[MW]	[km]							
Austria	9900	4603	8.8	58	14	55	10	x	s	x/a	s	s	x	s
Belgium	n.a.	n.a.	n.a.	n.a.	16	0	0					s	s	s
Bulgaria	6231	1561	21.1	68	6	0	0	x	x	x/a		s	s	s
Croatia	1800	410	n.a.	78	20	0	0	x	s		s	s	s	s
Cyprus	0	0	/	0	1	0	0	s	s	s	s	s	s	s
Czech Republic	23976	7665	n.a.	75	13	0	0	x	x		s	s	s	s
Denmark	22678	28700	16	73	49	34	13	s	x	s(3)	s	s	a	a
Estonia	5540	1430	12.7	37	10	0	0	x	s	x/a	s	s	s	s
Finland	23105	13556	8.4	73	35	247	86	x	s	a	s	s	s	s
France	20570	3685	17.8	23	3	669	152	x	x	a	s	s	x	x
Germany	48810	19650	13.0	81	13	168	55	s	s	s	s	s	s	s
Greece	445	658	n.a.	n.a.	4	0	0	s(1)	s(1)			s	s	s
Hungary	8008	2148	n.a.	n.a.	13	7	3	x	x			s	s(5)	a
Iceland	2266	6970	n.a.	n.a.	24	0	0	x	s(4)			s(5)	s	s
Ireland	0	0	/	0	8	0	0	s	s	s	s	s	s	s
Italy	7290	3161	15.2	68	12	172	64	s	s	a	s	s	s	x
Latvia	3425	1725	14.5	73	35	0	0	x	x	a	s	s	s	s
Lithuania	9320	2520	15.8	56	36	0	0	x	x	a	s	s	s	s
Luxembourg	n.a.	n.a.	n.a.	n.a.	64	n.a.	n.a.					s		
Malta	0	0	/	0	0	0	0	s	s	s	s	s	s	s
Netherlands	5725	3950	n.a.	n.a.	34	n.a.	n.a.	x	x			s		
Norway	3112	1498	10.5	2	0	136	54	x	s	a	s	s	x	x
Poland	57411	19880	n.a.	57	17	35	18	x	x		s	s	x	x
Portugal	n.a.	n.a.	n.a.	n.a.	14	n.a.	n.a.					s		
Romania	10480	6055	n.a.	90	11	0	0	x	s(4)		s	s	s	s
Slovakia	15793	4984	n.a.	31	27	0	0	s(5)	x		s	s	s	s



## Work package 2: Assessment of the technologies

	District heating					District cooling								
Slovenia	2294	744	15.5	77	8	1	1	x	x	a	s	s	x	x
Spain	852	216	n.a.	n.a.	9	317	174	s	s			s	s	s
Sweden	17500	233 89	12.5	41	9	650	438	s (4)	x	a	s	s	s (2)	x
Switzerland	2258	126 6	n.a.	53	3	0	0	x	x		s	s (5)	s	s
United Kingdom	335	361	n.a.	80	6	89	31	x	x		s	s	s (4)	a

n.a. = not available

### Methodology

x = interpolation / extrapolation

a = ad hoc calculation

s = direct use of the source

m = modelling

### Notes

(1): Value provided for the year 2007

(2): Value provided for the year 2009

(3): Value provided for the year 2010

(4): Value provided for the year 2011

(5): Value provided for the year 2013

Sources: (ADHAC, 2014; ADHAC, 2015; AGFW, 2013; AIRU, 2013; BASREC, 2014; CODE2, 2013; CODE2a, 2014; CSB; Dansk Fjernvarme, 2015; EIHP, 2015; ENS, 2015; EPHA, 2015; Euroheat & Power b; Euroheat & Power c; Euroheat & Power, 2015; Eurostat; FGW, 2015; Finnish Energy Industries, 2013; Finnish Energy Industries, 2015; LDHA, 2015; Persson, Urban, 2015; RESCUE, 2012./2013; SNCU; Statistics Norway; Statistics Sweden; SURS)

The figures in Table 58 and Table 59 refer to the stock of plants used in 2012 for district heating production. This kind of data is hardly available as often not even the district heating associations collect it and it was therefore decided to present data for only a number of countries. Even in this case, the total installed thermal capacity may show a relatively high discrepancy to the values in Table 57. More detailed data is available in the Excel spreadsheet attached to the report.

Table 58: District heating technology supply composition – installed thermal capacity.

	CCGT	Gas Turbine	IC engine	Steam Turbine	Nuclear Plant	Boiler, gas	Boiler, oil	Boiler, coal	Recycled process heat	Boiler, electric	Boiler, biomass	Incineration plant	Solar thermal	Heat pumps	Geothermal CHP and Heat only
	[MW]	[MW]	[MW]	[MW]	[MW]	[MW]	[MW]	[MW]	[MW]	[MW]	[MW]	[MW]	[MW]	[MW]	[MW]
Cyprus	0	0	0	0	0	0	0	0	0	0	0	0	0	0	0
Denmark	1168	585	1441	6627	0	4866	5435	10	254	375	1305	140	200	5	33
Estonia	0	0	17	731	0	3066	1224	41	0	23	2	0	0	0	0
Finland	n.a.	329	73	6862	0	5506	8307	1039	51	288	2717	218	2	128	0
Germany	4458	1426	730	13042	0	12948	966	966	5142	n.a.	193	4252	23	0	271
Iceland	n.a.	0	0	n.a.	0	n.a.	n.a.	n.a.	0	n.a.	n.a.	n.a.	0	0	2172
Ireland	0	0	0	0	0	0	0	0	0	0	0	0	0	0	0
Italy (1)	1292	126	262	386	0	4048	80	0	11	0	168	499	2	19	129
Lithuania	34	0	4	950	0	3366	1431	20	0	0	645	0	0	0	14
Malta	0	0	0	0	0	0	0	0	0	0	0	0	0	0	0
Norway	0	0	0	n.a.	0	405	875	0	n.a.	515	n.a.	n.a.	0	0	0
Romania (2)	188	186	132	9974	n.a.	0	0	0	0	0	0	0	0	0	107
Spain (3)	0	0	0	0	0	402	17	0	n.a.	212	218	n.a.	3	n.a.	0

n.a. = not available

### Notes

(1): Not including networks with provisional data

(2): Backup boilers not separately accounted

(3): Non-defined renewables accounted within the category 'biomass furnace'

Sources: (A. Karagiannidis; EEA; SDH; EGEC, 2013; IAEA, 2013; M. Jofra Sora, 2013; EEA b, 2013; ANRE, 2013; CODE2, 2013; AGFW, 2013; AIRU, 2013; CODE2a, 2014; CODE2b, 2014; Euroheat & Power, 2015; Finnish Energy Industries, 2015; Finnish Energy Industries, 2015; EGEC, 2015; Dansk Fjernvarme, 2015; ADHAC, 2015; NFV, 2015; EPHA, 2015. )

Table 59: District cooling technology supply composition – installed cooling capacity.

	<b>Compression refr.</b>	<b>Sorption cooling</b>	<b>Free cooling</b>	<b>Heat pumps (cooling)</b>
	[MW]	[MW]	[MW]	[MW]
Belgium	0	0	0	0
Bulgaria	0	0	0	0
Croatia	0	0	0	0
Cyprus	0	0	0	0
Czech Republic	0	0	0	0
Estonia	0	0	0	0
Finland	25	35	115	73
France	650	19	0	0
Germany	58	43	n.a.	n.a.
Greece	0	0	0	0
Hungary	4	3	0	0
Iceland	0	0	0	0
Ireland	0	0	0	0
Italy	45	126	0	0
Latvia	0	0	0	0
Lithuania	0	0	0	0
Malta	0	0	0	0
Poland	10	23	2	0
Romania	0	0	0	0
Slovakia	0	0	0	0
Slovenia	0	1	0	0
Switzerland	0	0	0	0

n.a. = not available

Sources: (RESCUE, 2012./2013; AGFW, 2013; AIRU, 2013; BASREC, 2014; Euroheat &amp; Power, 2015; Persson, Urban, 2015; Finnish Energy Industries, 2015. )

## 4.2 Combined heat and power (> 1 MW<sub>th</sub>)

The following section describes combined heat and power (CHP) technologies with an electrical capacity of above 1 MW<sub>th</sub>. Such plant is predominantly used in the industry and district heating sector. As the scope and characterisation of CHP technologies has been described in the previous chapters 3.2 and 4, this chapter focuses on the stock description and distribution. The following (groups of) technologies are distinguished in the analysis below.

- Combined-cycle CHP power plant
- Gas turbine
- Steam turbine
- Internal combustion engine
- Other (including stirling engine, Organic Rankine Cycle (ORC) and fuel cell)

The analysis of the CHP-stock is based on two main sources:

- Combined Heat and Power (CHP) data published by Eurostat (Eurostat, 2015)
- UDI World electric power plants database PLATTS (Bergesen, 2014)

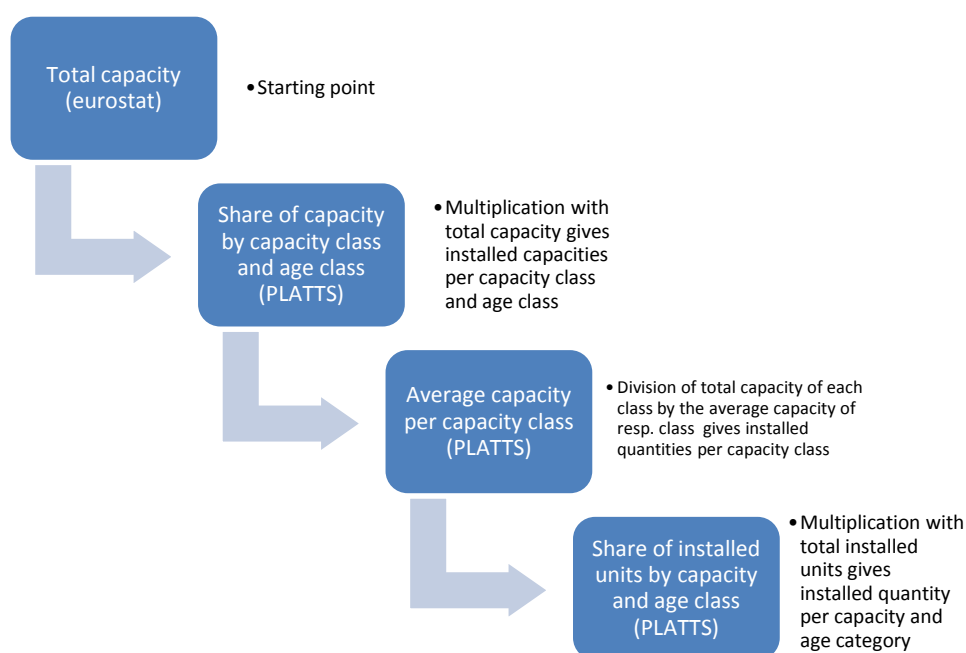
As described in chapter 4, there are several difficulties using the PLATTS database for analysing combined heat and power plants in district heating systems, as it is impossible to identify the CHP-plants connected to a district heating system with absolute certainty. Similar difficulties arise with the analysis of CHP-plants installed in the industrial sector (for providing process heat). Nevertheless, the database includes valuable information about the age of installed CHP plants applying the technologies listed above. Furthermore, it can be used to analyse the share of different capacity classes in the total installed capacity and quantity, as well as average capacities per unit for the defined capacity classes. The described information is available by country.

Eurostat on the other hand provides information about the total installed electrical and thermal capacity of CHP plants in all member states and Norway. The overall thermal CHP-capacity was used as a starting point for the results presented below. The age and capacity class distribution was calculated using the shares derived from analysing the PLATTS database. The procedure is illustrated in Figure 67 while the capacity and age categories are listed in Table 60.

Table 60: Capacity and age categories

Capacity categories	Age categories
1 – 5 MW <sub>th</sub>	Before 1992
5 – 25 MW <sub>th</sub>	1992 – 2002
25 – 100 MW <sub>th</sub>	After 2002
>100 MW <sub>th</sub>	

Figure 67: Procedure to calculate the stock distribution (capacity and age category) using Eurostat data and the PLATTS database.

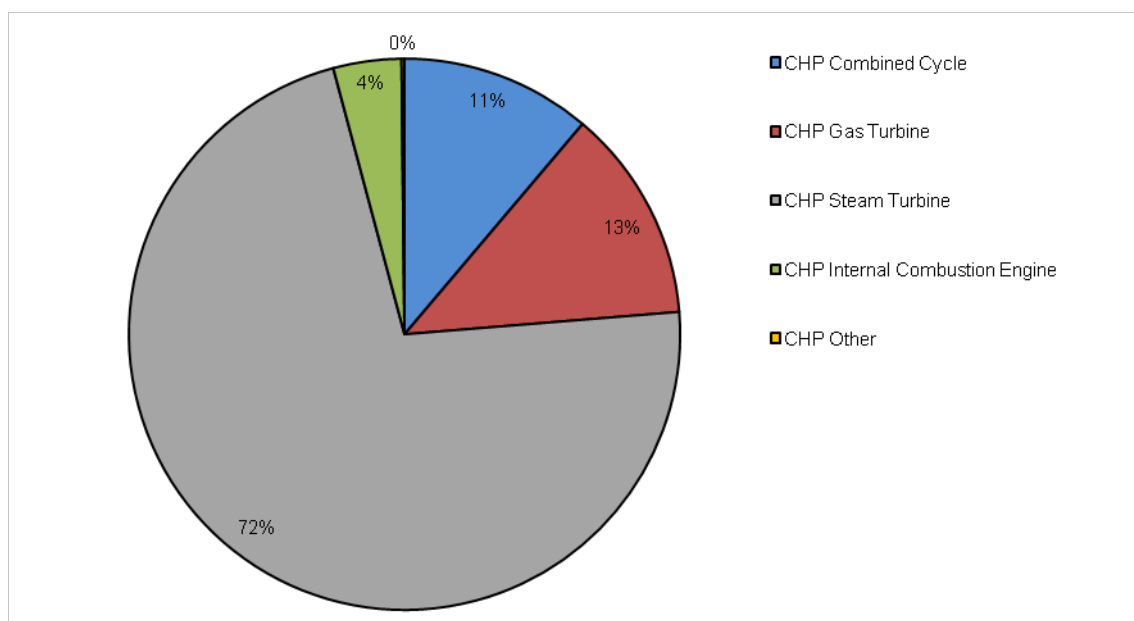


Source: own illustration

The calculated stock of CHP installations above 1 MW<sub>th</sub> capacity in Europe is discussed in the following paragraphs.

The total installed thermal capacity in the EU28 amounts to 285 GW<sub>th</sub> in 2012. Figure 68 shows the total installed capacity by technology type for the EU28. As can be seen, steam turbines account for the major share with 72% of the total capacity. Gas turbines account for 13% and combined cycle plants for 11%. In terms of capacity, internal combustion engines only account for 4%. Remaining technologies such as Stirling engines, ORC or fuel cells play a marginal role with less than 0.5% of capacity.

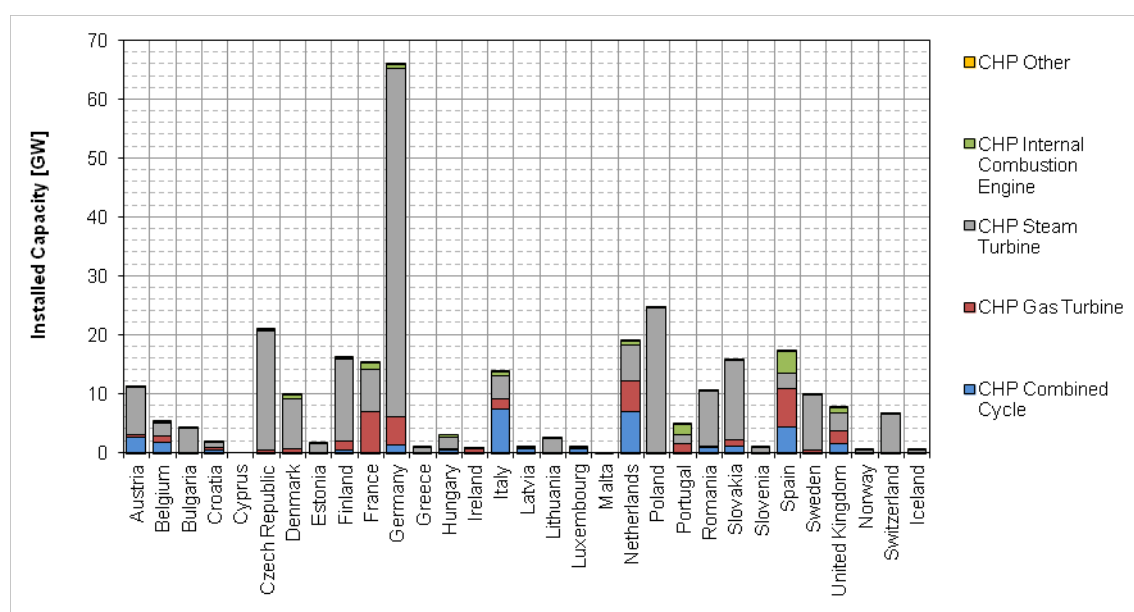
Figure 68: Installed thermal capacity of CHP plants (> 1 MWth) in the EU28 in 2012.



Source: own calculation based on Bergesen, 2014; Eurostat, 2015

In Figure 69 the installed thermal capacity is illustrated for each country and CHP-technology. The total capacity, as well as the technology structure, vary substantially by country. Germany has the highest capacity with a total of 66 GWth, followed by the Czech Republic (25 GWth), Poland (21 GWth) and the Netherlands (19 GWth).

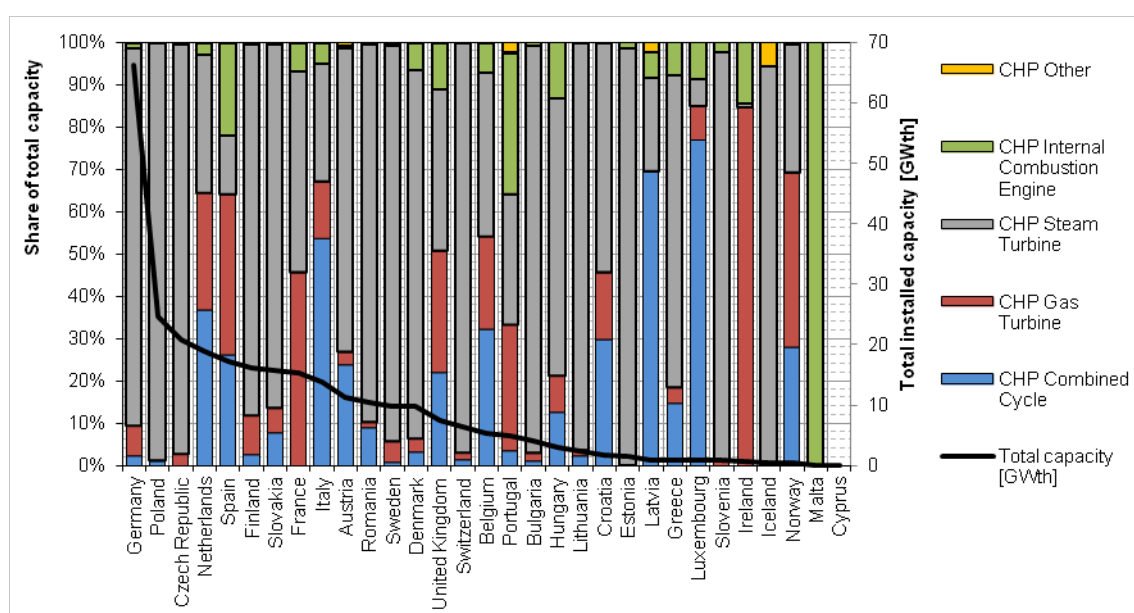
Figure 69: Thermal capacity of combined heat and power plants in Europe.



Source: own calculation based on Bergesen, 2014; Eurostat, 2015

The split of the different CHP technologies (with respect to the thermal capacity) by country is also shown in Figure 70. In terms of relative capacity steam turbines are the main CHP technologies in most European countries. This is true inter alia for the countries with the highest installed capacity, being Germany (approx. 90%), Poland (almost 90%) and the Czech Republic (approx. 98%). The Netherlands have the fourth highest installed capacity, but in contrast to the previously cited countries, steam turbines are not the dominating CHP technology; in the Netherlands, the greatest proportion is provided by combined cycle CHP plants (approx. 38%). Internal combustion engines provide a relatively high proportion in Portugal (approx. 36%) and Spain (approx. 22%), but they provide only marginal shares in countries such as Poland, Czech Republic, Finland, Slovakia, Austria and Romania.

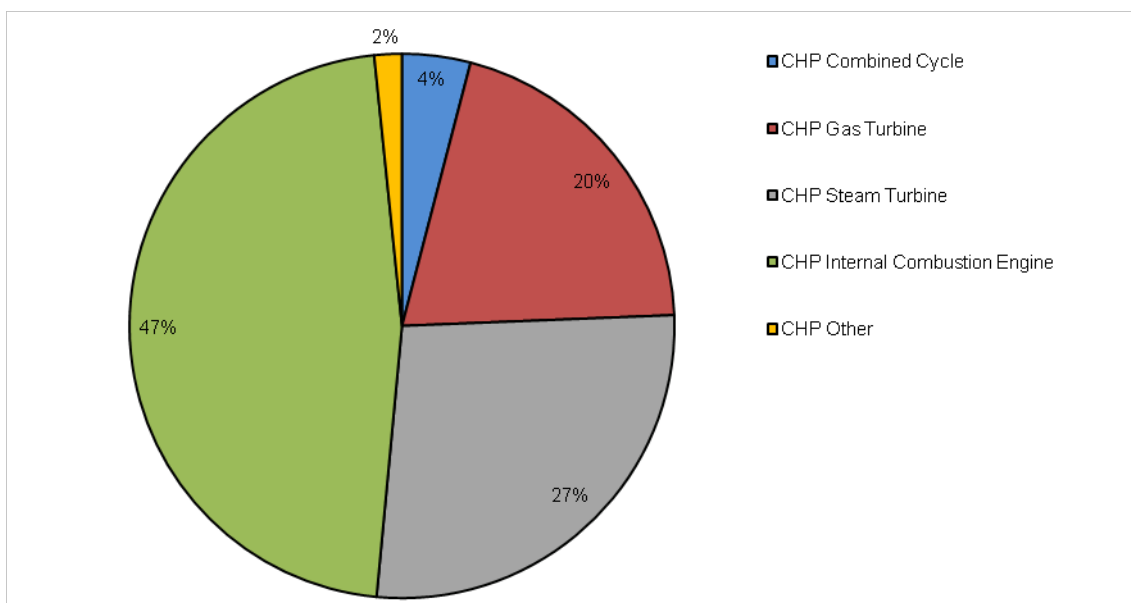
Figure 70: Relative portion of thermal capacity of combined heat and power plants in Europe.



Source: own illustration based on Bergesen, 2014; Eurostat, 2015

The picture looks different when examining the quantity of CHP installations in Europe. As can be seen in Figure 71, internal combustion engines make up nearly half of the total number of installations in the EU28. At the same time, the importance of steam turbines – which are typically used in much larger plant – is reduced to 27%.

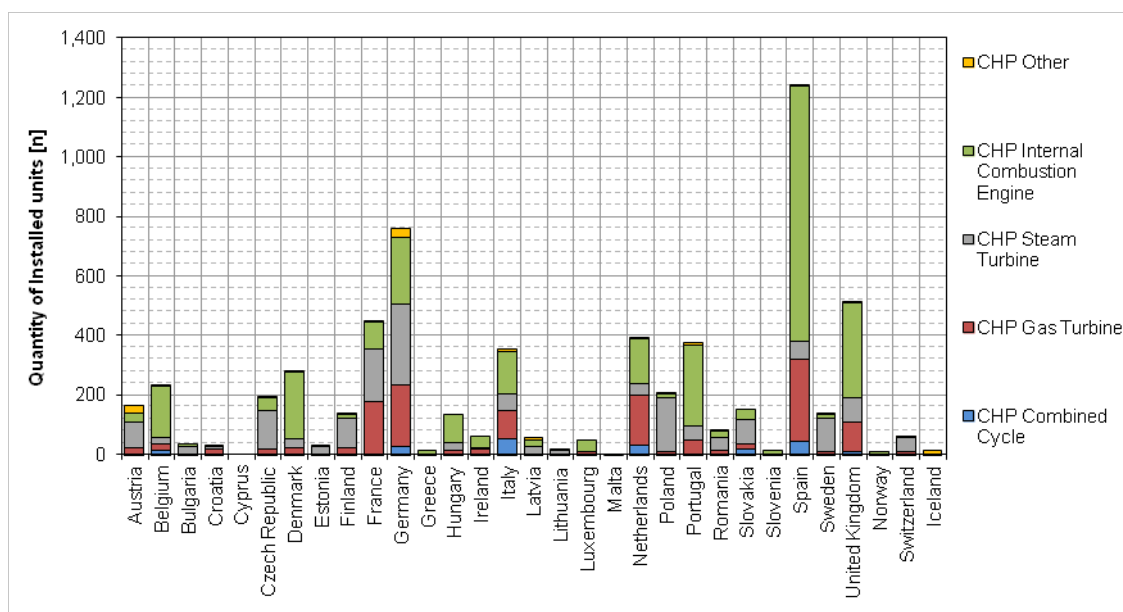
Figure 71: Stock of combined heat and power plants (> 1 MW<sub>th</sub>) in the EU28 in 2012 as share of total stock.



Source: own calculation based on Bergesen, 2014; Eurostat, 2015

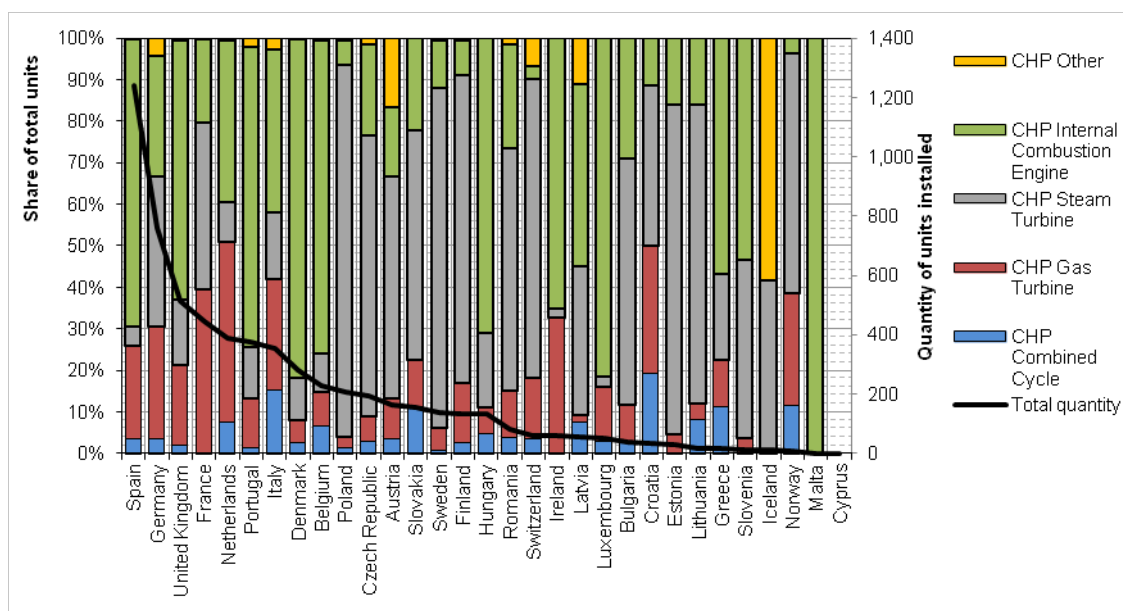
A breakdown of the number of CHP plants by country is shown in Figure 72 and 5. In Figure 72 the installed quantity of large scale (> 1 MW<sub>th</sub>) combined heat and power plants is illustrated for each country and technology. In terms of installed units, internal combustion engines are the main CHP technologies in most European countries. This is true for the country with the highest installed quantity (Spain; approx. 70%), but also for smaller countries such as Denmark (almost 82%), Belgium (approx. 75%) and Malta (100%). The relative portions of the different CHP technologies (related to the installed quantity) by country is shown in Figure 73. This shows that when looking at the number of installed units most countries are dominated by CHP technologies that have small capacities (internal combustion engines). The order of the countries strongly differs between Figure 70 and Figure 73 because large CHP power plants usually dominate in countries with high installed capacities, while in smaller countries with lower installed capacities there are usually more internal combustion engines. These have a much smaller capacity per unit.

Figure 72: Stock (quantity) of combined heat and power plants in Europe in 2012



Source: own calculation based on Bergesen, 2014; Eurostat, 2015

Figure 73: Relative portion of technologies in the stock of combined heat and power plants in Europe.



Source: own calculation based on Bergesen, 2014; Eurostat, 2015

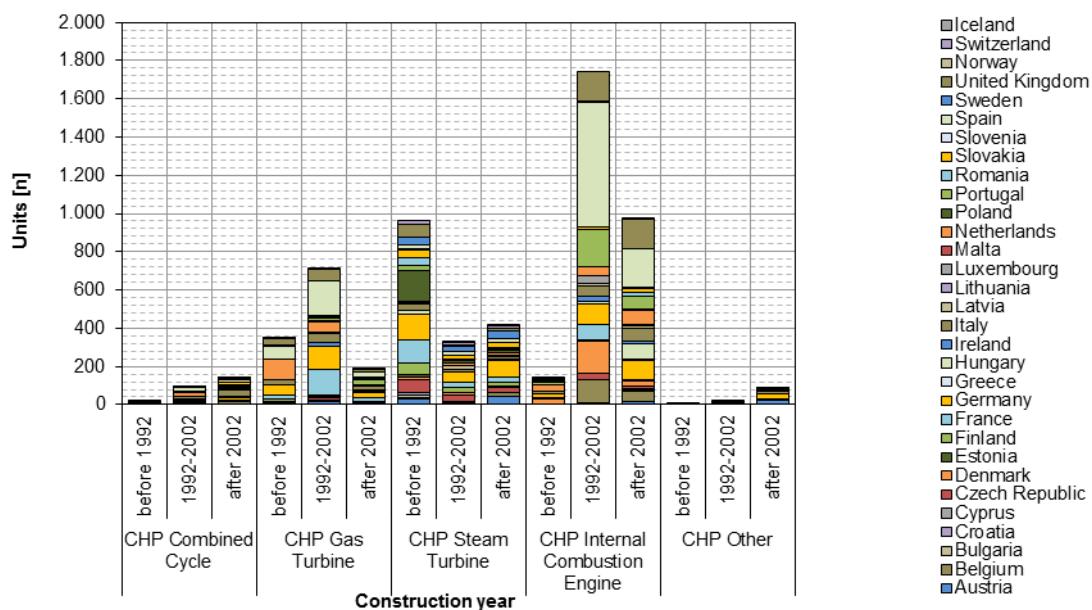
The age of the CHP stock varies significantly both between the different technologies, and the countries. The age distribution by technology and country is illustrated in Figure 74. Most steam turbine CHP plants were installed before 1992 and these are the oldest CHP technology in Europe (see also Figure 76, in which the installed capacity is illustrated). Combined cycle CHP plants and other CHP technologies, on the other



hand, have largely been installed after 2002 and are – relatively – the newest CHP technologies. Internal combustion engines mostly date back to the 1990s, although a considerable proportion has been built since 2002.

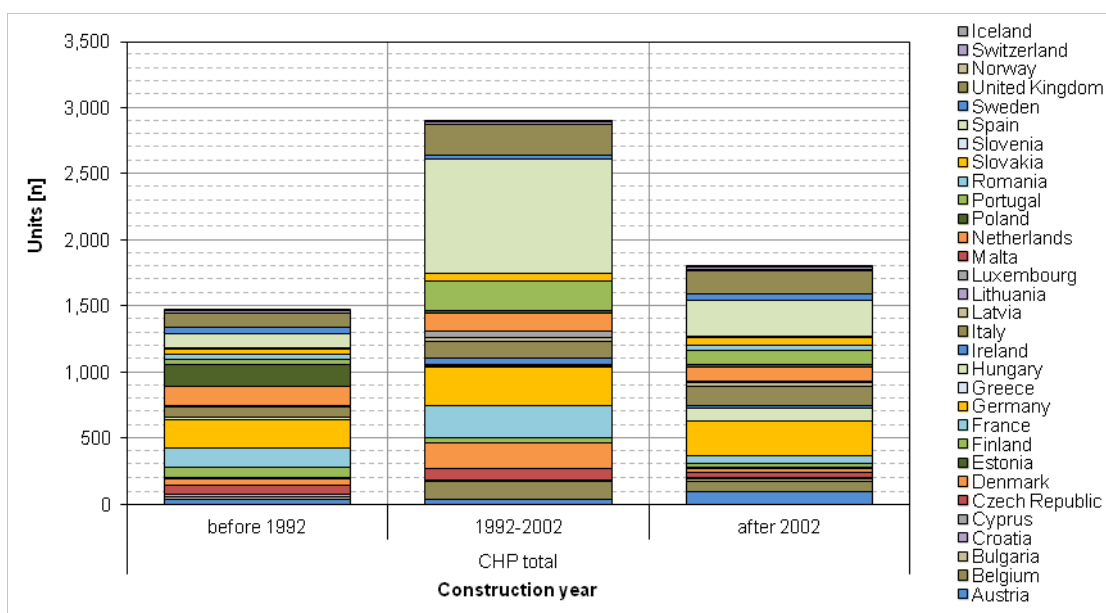
Figure 75 and Figure 77 show the age distribution of total installed quantity and capacity of CHP plants in Europe. 54% of the thermal capacity was installed before 1992, being mostly steam turbines in central and eastern European countries.

Figure 74. Age distribution of installed units of CHP plants by technology in Europe.



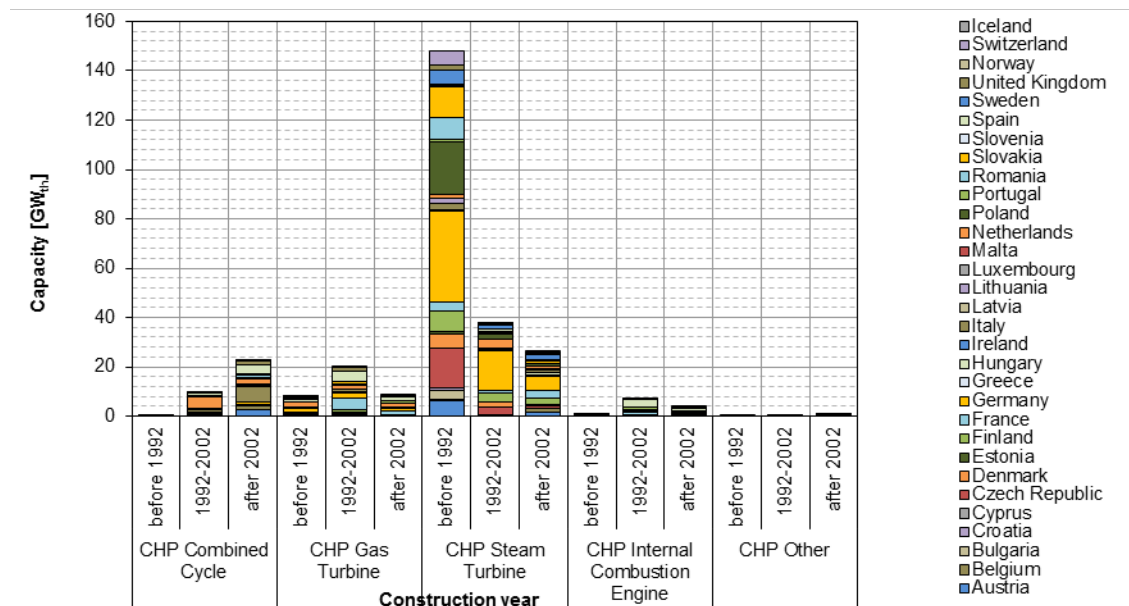
Source: own calculation based on Bergesen, 2014; Eurostat, 2015

Figure 75: Age distribution of installed units of CHP plants in Europe.



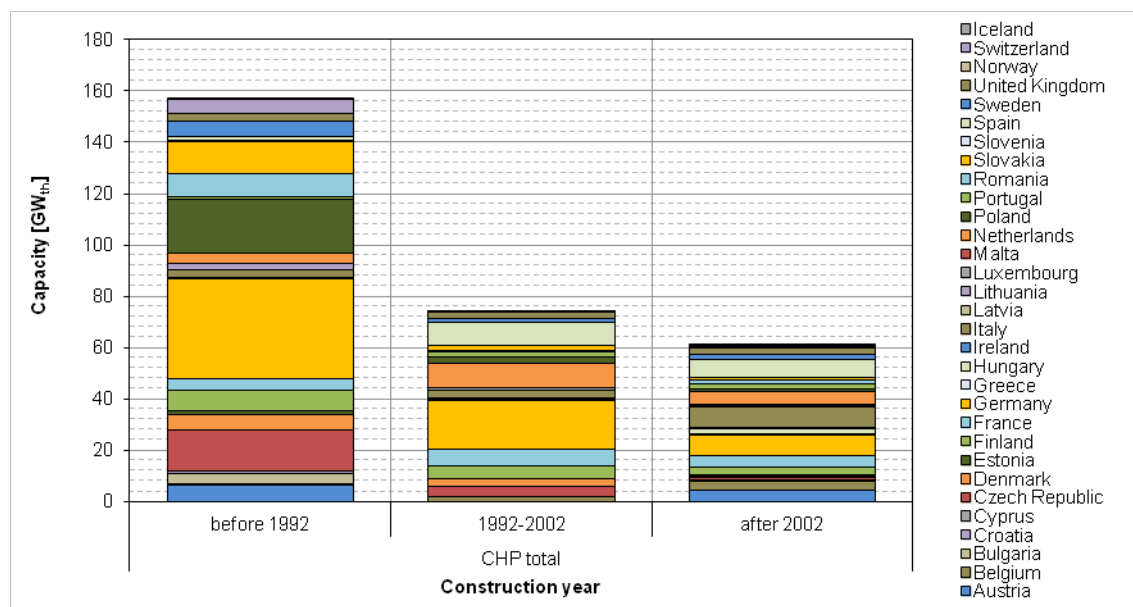
Source: own calculation based on Bergesen, 2014; Eurostat, 2015

Figure 76: Age distribution of installed capacity of CHP plants by technology in Europe.



Source: own calculation based on Bergesen, 2014; Eurostat, 2015

Figure 77: Age distribution of installed capacity of CHP plants in Europe.

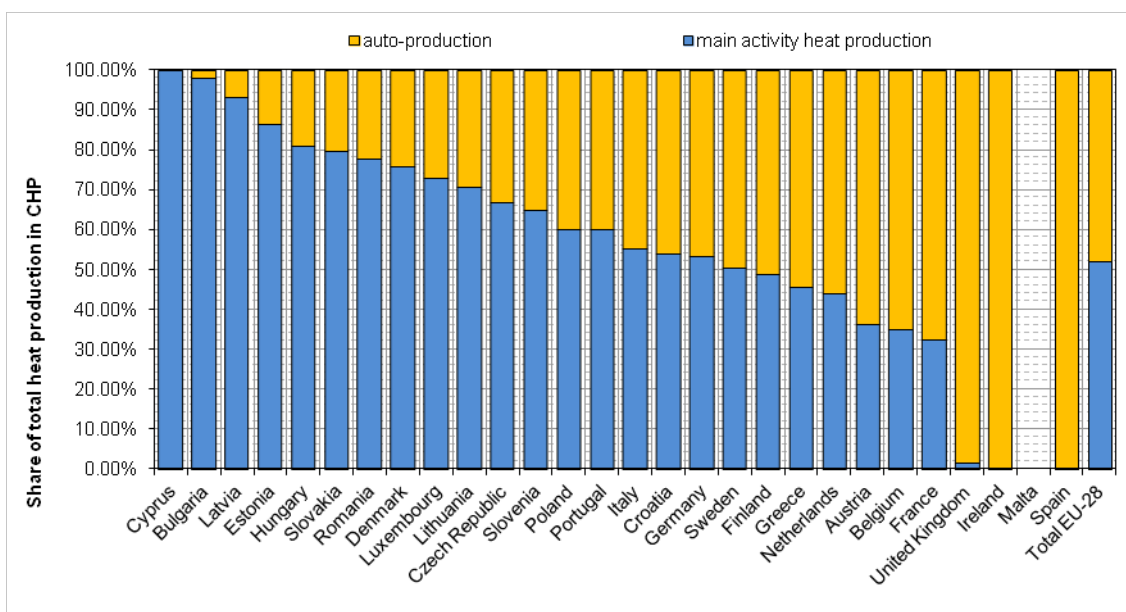


Source: own calculation based on Bergesen, 2014; Eurostat, 2015

Eurostat (2015) publishes summary CHP statistics for the EU countries. Large CHP

plants are mostly used in the industrial sector (most of auto-production) as well as for public heat supply in district heating networks (“main activity heat production”). The proportion of both uses, however, varies substantially by country, as can be seen in Figure 78. In eastern and central European countries the share of heat produced by CHP for district heating is relatively high, ranging from 65% in Slovenia to 98% in Bulgaria. Countries with the by far lowest share of district heating in total CHP heat production are Ireland (0%), Spain (0%) and the United Kingdom (1%). Most western European countries range between 32% (France) and 60% (Portugal). On average, in the EU28 52% of CHP heat production is for district heating uses.

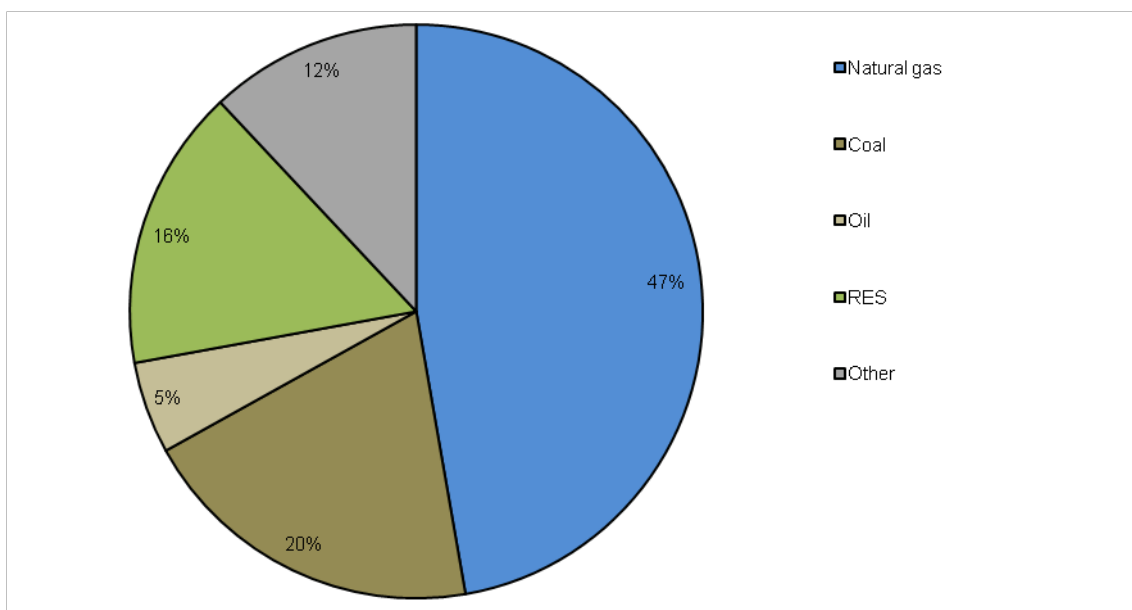
Figure 78: Share of total heat production in CHP by type of activity in 2012.



Source: Eurostat 2015

Eurostat (2015) also provides data on fuels used for CHP heat and electricity generation (Figure 79). This indicates that natural gas accounts for 47% of fuel demand in CHP, coal 20% and renewable energy sources 16%.

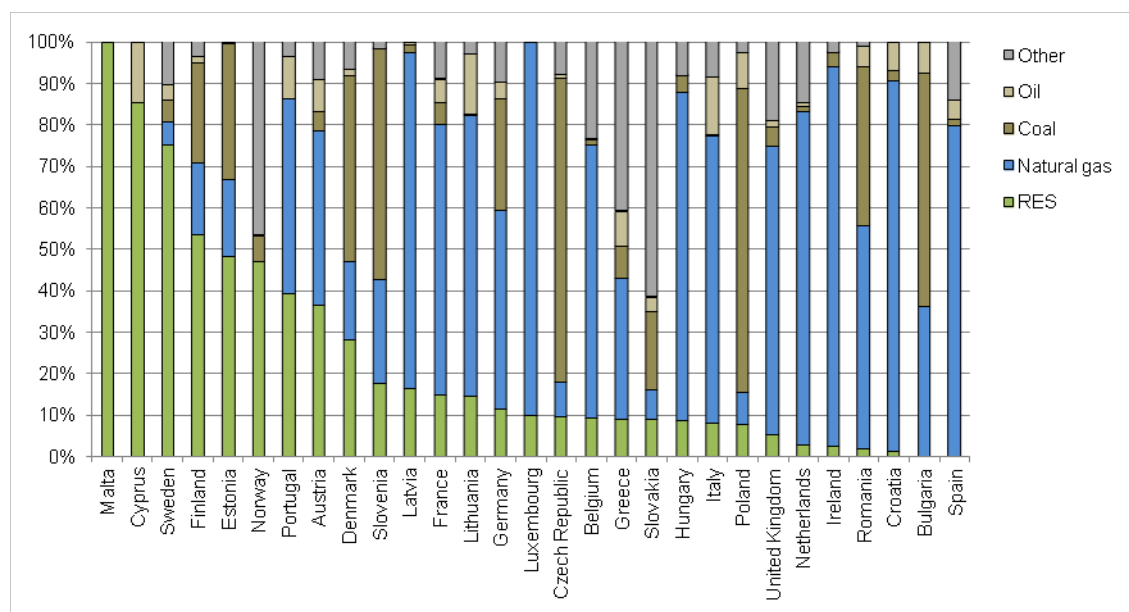
Figure 79: Share of final energy for CHP use (>1 MW<sub>th</sub>) by fuel type in the EU28 in 2012.



Source: Eurostat 2015

There is also a substantial diversity in the use of fuels across the countries (Figure 80). While in Ireland, Luxembourg, Croatia, Latvia and the Netherlands the share of natural gas is above 80%, Norway, Malta and Cyprus do not use natural gas at all for CHP generation. The use of renewable energies also varies significantly. The Nordic countries are among the large CHP users and use relatively high proportions of renewable energy sources in CHP generation: Sweden (75%), Finland (54%) and Norway (47%). Other major CHP producers like Spain or Bulgaria use low shares of RES - below 1%. The proportion of coal used is relatively high in many eastern and central European countries such as the Czech Republic, Poland, Bulgaria, Slovenia and Romania, but also Denmark.

Figure 80: Share of final energy for CHP use (>1 MW<sub>th</sub>) by fuel type and by country in 2012.



Source: Eurostat 2015

In summary, the combination of the PLATTS database with Eurostat summary statistics provides a detailed picture of the European stock of CHP units with a capacity above 1 MW<sub>th</sub>. The figures, however, have to be interpreted with caution. In particular, the proportions of the type of technology might deviate to a certain degree from national sources. However, the general picture provided seems to be robust and represents national particularities.

**Fehler! Verwenden Sie die Registerkarte 'Start', um Heading 1 dem Text zuzuweisen, der hier angezeigt werden soll.**

## **5 Summary and recommendations**

The focus of work package 2 was to acquire detailed information about the heat and cooling supply technology stock in the European Union, and in Norway, Switzerland and Iceland. The data can be distinguished between applications in the building sector (chapter 2) industry sector (chapter 3) and in the district heating and cooling systems (chapter 4). The main challenge in all sectors analysed is data acquisition. There is almost no data source in which detailed information on installed units and capacities for the different countries is combined. Therefore, many different data sources had to be used and integrated into a consistent set of data. However, in some cases data were not publicly available at all. Furthermore, the data were not usually available at the desired level of detail. Therefore, modelling results had to be used to fill data gaps and the main findings in the different sectors are summarised in the following sections.

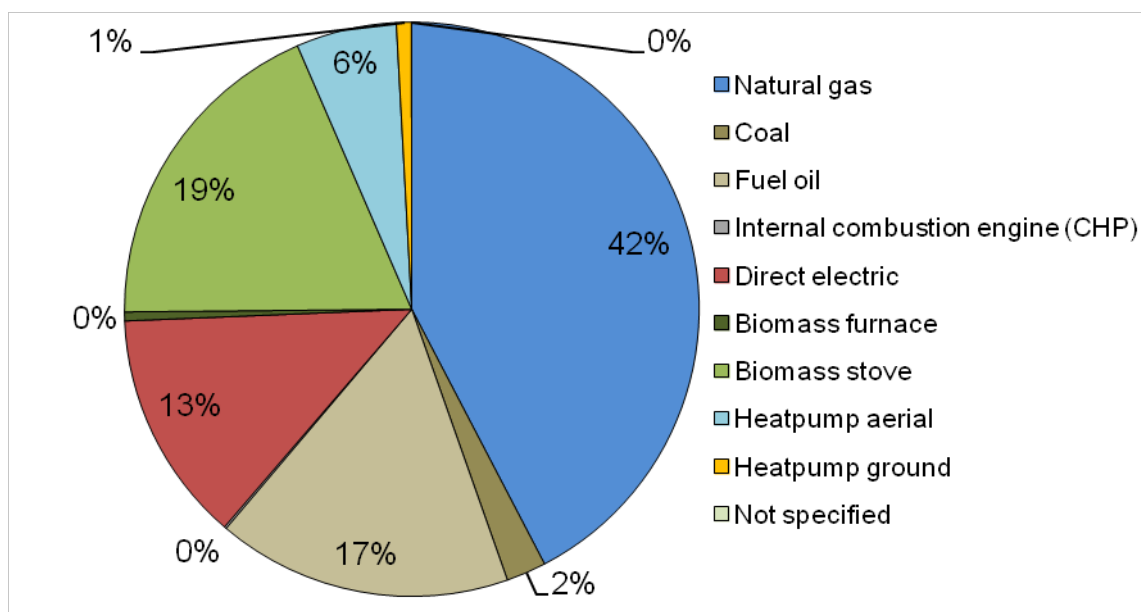
## 5.1 Space heating and cooling in buildings

The space heating sector in European buildings is dominated by fossil fuel burning technologies as illustrated in Figure 81 and Figure 82 (installed units). Norway, Switzerland and Iceland are not considered in the figures and description below as data on installed units and capacities were not available for all technologies and could have led to misleading interpretations. Nevertheless, the country specific composition of the heating market (buildings) varies widely (country specific figures illustrating the composition of heating technologies with respect to installed capacity are given in the appendix chapter 7.1). Natural gas, oil and coal boilers account for 61% of the total installed thermal capacity and 50% of the installed units. If small scale CHP applications and especially direct electric heating systems are counted as “fossil” technologies the share is even higher (74% of installed capacity and 62% of installed units). The proportion of the different heating technologies is highly dependent on the country’s conditions and available energy resources. For countries in which natural gas is extracted, the proportion of gas heating systems is very high (e.g. the United Kingdom with a share of 86% and The Netherlands with a share of 94% with respect to installed capacity). On the other hand natural gas is not used at all in countries without their own resources and without a connection to the European gas infrastructure (e.g. Cyprus, Malta; these countries are dominated by fuel oil technologies, which provide shares of 94% and 68% respectively). In recent years / decades coal fired boilers have largely been replaced in most European countries. An exception is Poland where coal technologies still have a share of 36% in the total installed heating capacity. In contrast with the countries having majority shares of fossil fuel fired technologies (natural gas, fuel oil and coal) there are countries using very low proportions of fossil fuel fired technologies (e.g. Sweden, Estonia and Finland with shares of installed gas, oil and coal fired technologies of 7%, 10% and 13% respectively).

Biomass burning heating technologies also play an important role. Approximately 20% of the installed capacity and 26% of the installed units use biomass for heating purposes in buildings in Europe. Countries with a very high share of biomass burning technologies in the installed capacity are Estonia with 73%, Latvia with 65%, Slovenia with 63% and Romania with 57%. It has to be mentioned that biomass stoves and furnaces are usually secondary heating systems and the share of biomass in the heat generation in buildings is below the proportion of installed capacity (c.f. work package 1).

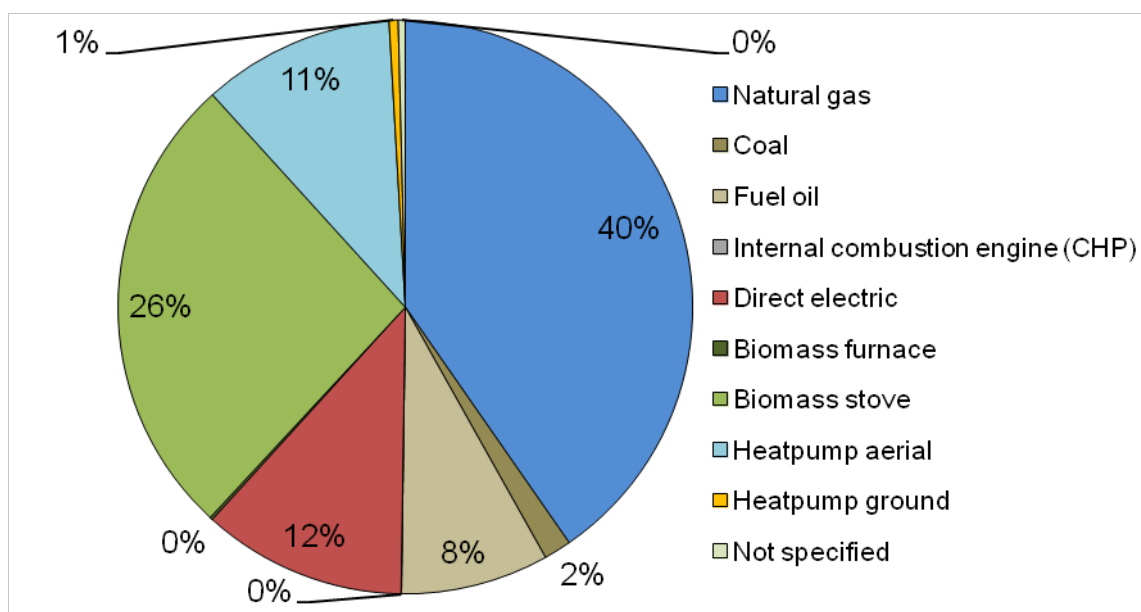
Heat pump technologies are a relatively new technology compared with fossil fuel, biomass burning technologies, and direct electric heating systems. Nevertheless, heat pumps represent 7% of installed capacity and 12% of installed units. Heat pump statistics can also include cooling devices, which play a major role in southern European countries such as Italy (in Italy heat pumps represent 22% of the total installed capacity). Cooling devices are aerothermal reversible heat pumps. These devices are mainly used for air-conditioning/ cooling, especially in countries with a warm climate and high cooling demand. In some national statistics they are counted as heat pumps, whereas in other countries it is only the aerothermal heat pumps used for heating purposes which are taken into account in the heat pump statistic. This is in line with the accounting of the European Heat Pump Association (EHPA). The difference between the two approaches can be seen in Italy; while national statistics indicate that more than 15 million aerothermal heat pumps exist, including reversible heat pumps used for cooling, EHPA only counts about 1 million (see chapter 2.4). The numbers taken into account in the figures below are those described in chapter 2.4. More information about the differences in heat pump statistics is given in this chapter.

Figure 81: Installed heating capacity in buildings in EU-28.



Source: own illustration based on the sources given in chapter 2.

Figure 82: Installed heating units in buildings in Europe.

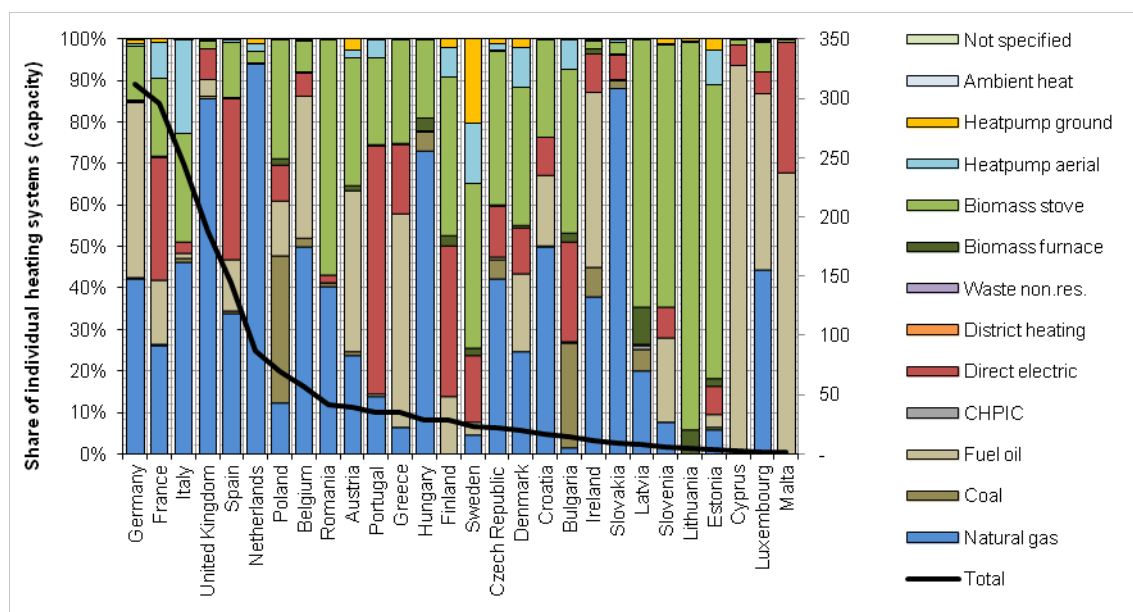


Source: Own illustration based on the sources given in chapter 2.

Figure 83 (installed capacity) and Figure 84 (installed units) illustrate the share of different heating technologies in buildings and the total installed capacities and units in the EU-28. The most relevant heating markets both in terms of installed capacity and installed units are the large European countries of Germany, France, Italy, the UK and Spain.

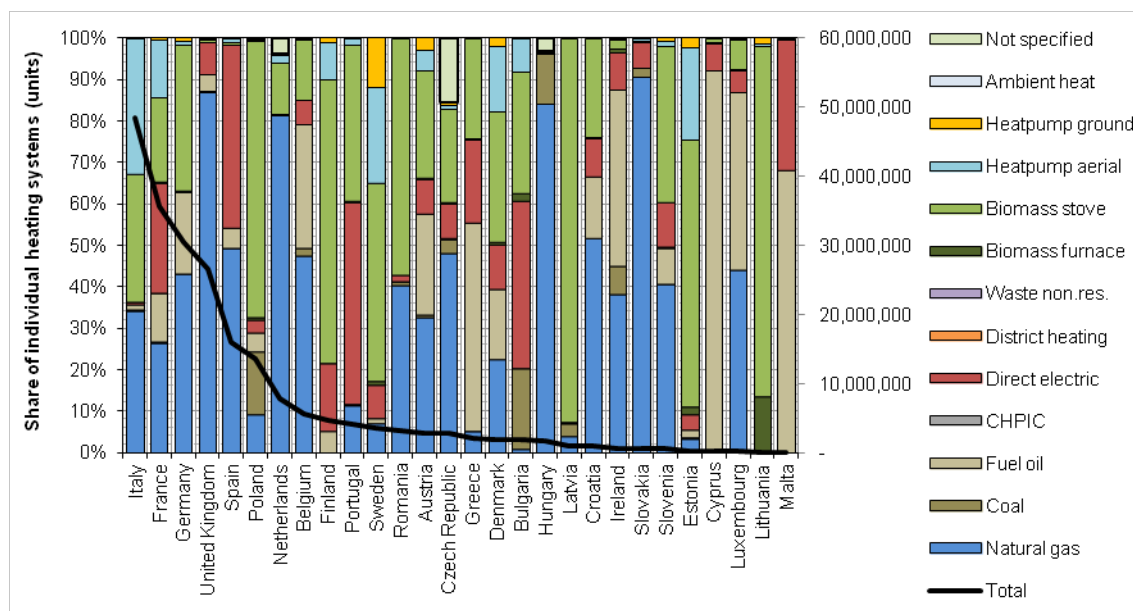


Figure 83: Share of heating technologies and total installed capacity by country (EU-28).



Source: own illustration based on the sources given in chapter 2.

Figure 84: Share of heating technologies and total installed units by country (EU-28).

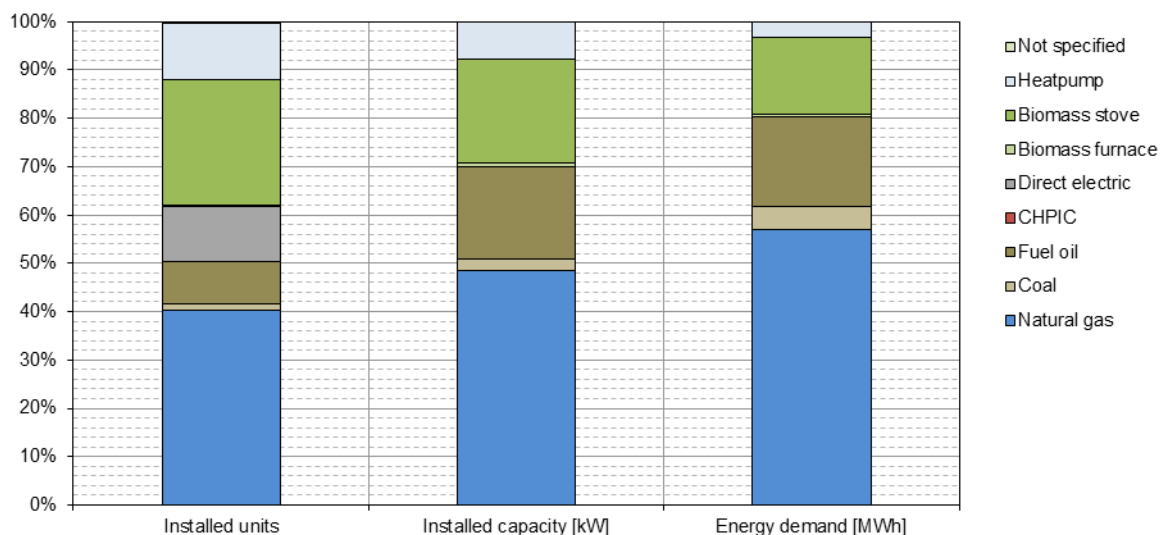


Source: own illustration based on the sources given in chapter 2.

In Figure 85 the relative share of installed units, capacities and energy demand (values for space heating and hot tap water in households and the tertiary sector taken from Workpackage 1) is compared. It can be seen that fossil technologies usually have a higher capacity per unit than the average of all technologies. Furthermore, they have more operating hours per year than the average, which can be seen in the in-

creasing portion of the technologies from installed units via installed capacity to the energy demand.

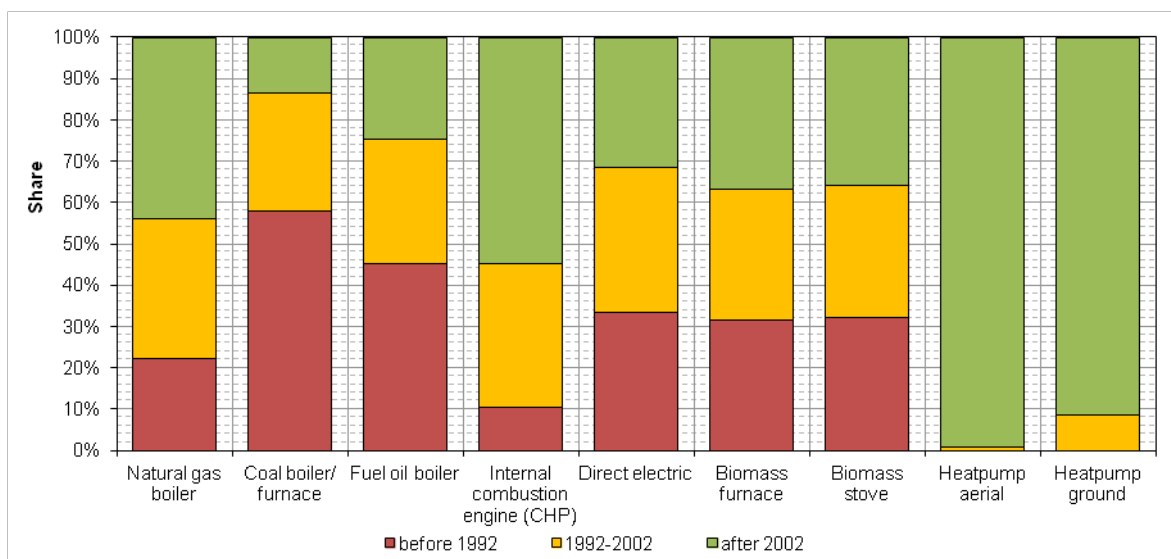
Figure 85: Share of heating technologies related to final energy carriers in terms of installed units and installed capacity, as well as the share of final energy demand by fuel in the investigated countries.



Source: own illustration based on the sources given in chapter 2 and in Workpackage 1.

Most heating technologies in buildings were installed after 1992. This is the case for both installed units (74%) and installed capacity (71%). The age distribution in the EU-28 differs between renewable energy technologies and conventional heating technologies (fossil fuel boilers, direct electric etc.). 76% of the renewable capacity was installed after 1992 whereas only 69% of the fossil capacity was installed in the same time period. This is also reflected in the age distribution of installed quantities; 77% of all renewable technologies and 72% of the fossil fuel fired and direct electric technologies were installed after 1992. The oldest heating technologies are those based on coal with 58% installed before 1992 and only 14% installed after 2002. The newest are aerial heat pumps; 99% of the installed units were installed after 2002. The relative age distribution in the EU-28 by technology is illustrated in Figure 86. The age distribution, split between renewable technologies, fossil fuels, and direct electric technologies in the EU-28, is illustrated in Figure 87 (installed units) and Figure 89 (installed capacity).

Figure 86: Age of the heating technology stock (in terms of installed capacity) by technology in the EU-28.



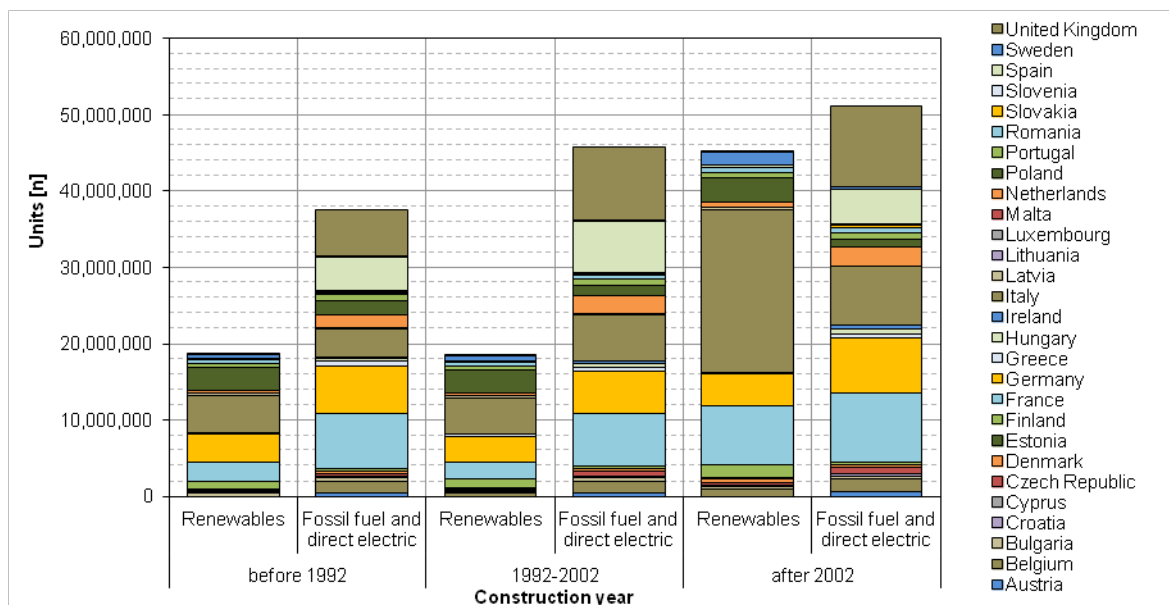
Source: own illustration based on the sources given in chapter 2.<sup>15</sup>

The countries with the oldest heating stock in terms of installed units are Cyprus, Poland and Greece where 45%, 36% and 36% respectively were installed before 1992. The newest heating stock can be found in Estonia (61% installed after 2002), Italy (60% after 2002; mainly due to high share of aerial heat pumps) and Sweden (54% installed after 2002). The proportion of the heating technologies (units) installed before 1992 is illustrated in Figure 90 for all countries, few which detailed data is available. Similar maps illustrating the proportion of heating technologies by country for fossil and renewable heating technologies can be found in the annex (see chapter 7.2).

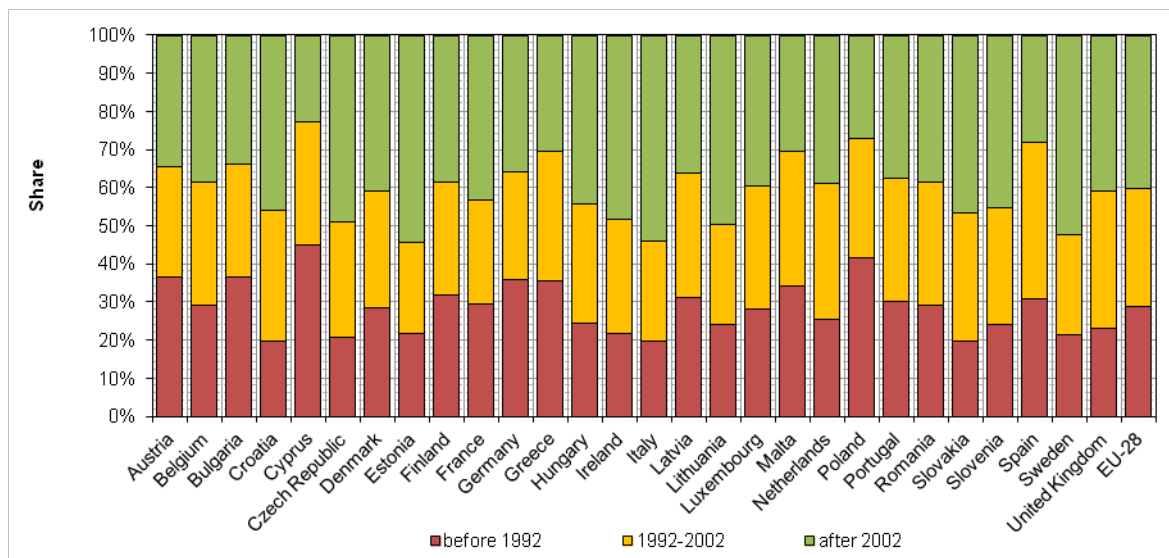
In terms of installed capacities, the proportions differ slightly, but it is the fact that the oldest heating stock is installed in Cyprus, Poland and Bulgaria and the newest in Estonia, Italy and Sweden. The age distribution by country and for the EU-28 as a whole is illustrated in Figure 88

<sup>15</sup> The age distribution of CHP internal combustion engines is only referring to Germany as the information is not available for the other Member States.

Figure 87: Installed renewable and fossil fuel (including direct electric) heating units by year of installation and country in the EU-28.

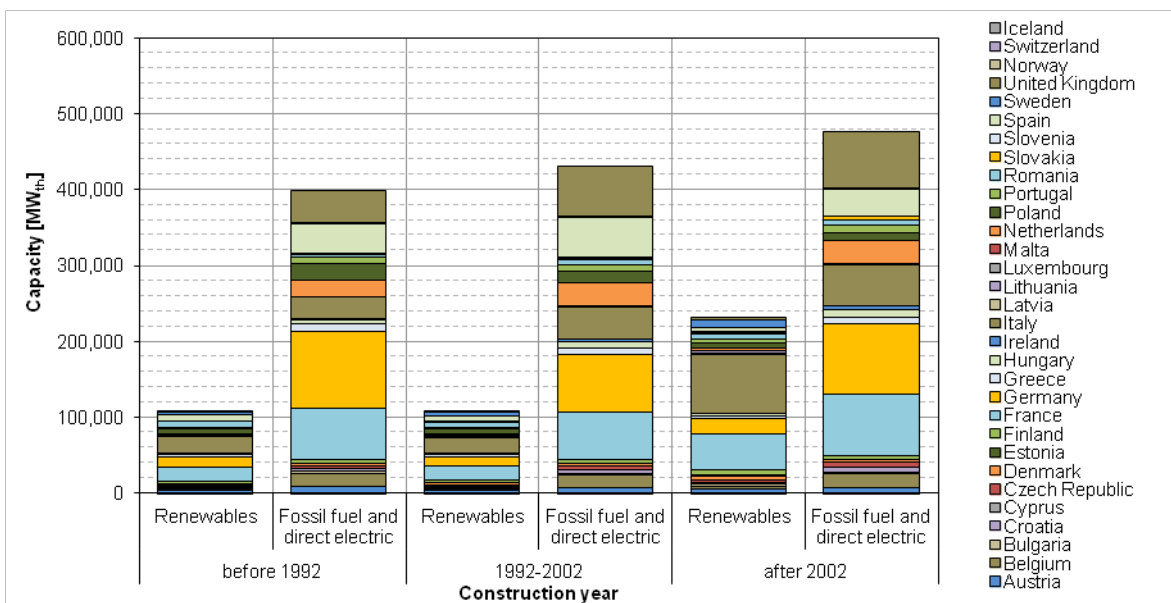


Source: own illustration based on the sources given in chapter 2. Figure 88: Age of the heating technology stock (related to installed capacity) by country and for the EU-28.



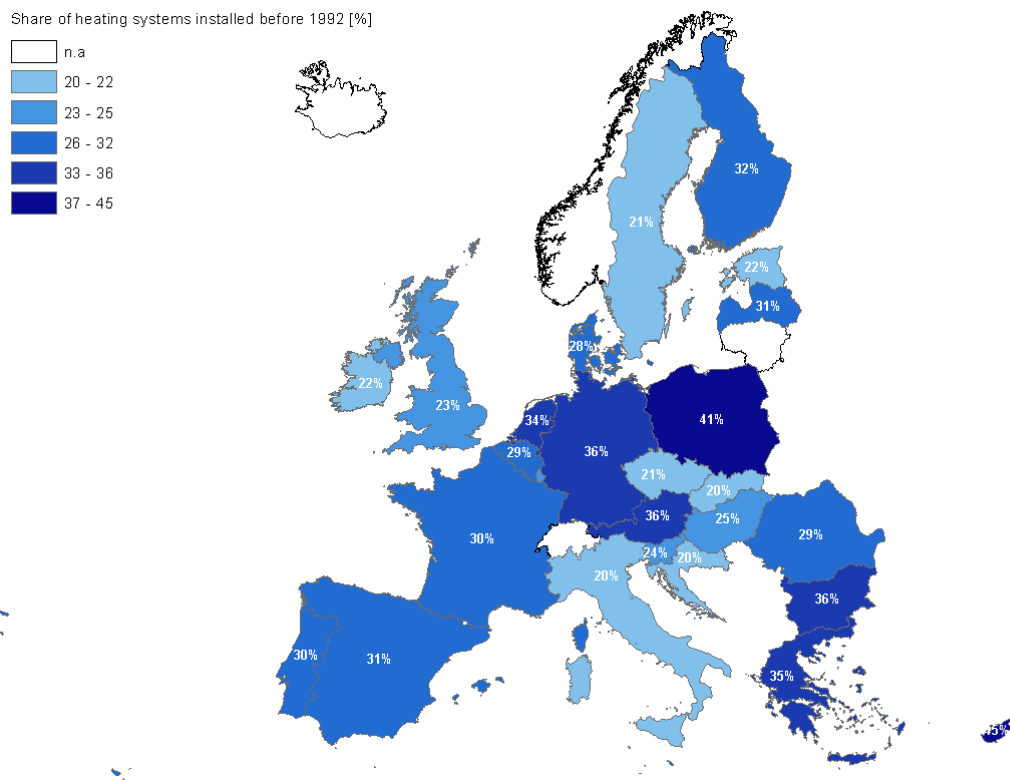
Source: own illustration based on the sources given in chapter 2.

Figure 89: Installed renewable and fossil fuel (including direct electric) heating capacities by year of installation and country in the EU-28.



Source: own illustration based on the sources given in chapter 2.

Figure 90: Proportion [%] of heating technologies (related to installed units) installed before 1992. The proportions are indicated for all countries, for which detailed data is available.



Source: own illustration based on the sources given in chapter 2.

## 5.2 Process heating and cooling

Process heat demand can be differentiated by direct use of heat (e.g. in furnaces) and indirect use of heat (via steam and hot water). The analysis considers technologies from both types of heat use including furnaces in the iron and steel industry, cement and glass production as well as CHP and steam boilers for steam and hot water supply across all industrial sub-sectors.

The analysed technologies cover 85% of the total process heat demand of around 2000 TWh in the EU28 in 2012. The remaining demand for process heating is mainly provided in furnaces scattered across many different processes in the non-ferrous metals industry, the chemical industry, food production and other sub-sectors.

Regarding the **completeness and quality of data** on the stock of technologies, the picture is very diverse. Information consists of the number and capacity of units installed, and the construction year. For some technologies, for example iron and steel, data from commercial sources are complete and even include the construction year of most plants. The database for CHP also provides very detailed analyses; however, the distinction between autoproduction (mainly industrial CHP) and central CHP for district heating is not robust and substantially underestimates the share of CHP in industrial autoproduction. For glass furnaces some information on the age of plants is available, while for clinker kilns there is no such information. The data situation is worst for steam boilers. For these, even the capacities by country had to be estimated. This is particularly astonishing given the significance of steam boilers which account for about one third of process heat demand.

**Thermal efficiency** has been assessed for both the average technology in the stock and for new technology on the market. The difference between these, however, is relatively low for most technologies. Replacing the entire technology stock for process heating with current technology would only improve energy efficiency a few percentage points.

The **use and potential of RES** is very much process specific. In the blast furnace of the steel industry coal is still the dominant energy carrier. The co-firing potential of solid biomass is limited and is still an issue of R&D. In the cement industry, however, co-firing of waste (renewable and fossil) as well as biomass in the clinker kiln is common practice and depends on energy prices. However, due to the low calorific value of biomass compared to coal for example, there are technical limits to co-firing in the clinker kiln. In glass melting furnaces, natural gas is the dominant fuel due to reasons of process control and purity. While renewable sources are currently not used, the use of biogas in glass melting furnaces is subject to R&D projects. In CHP as well as steam boilers, RES have been used in the past, although only in selected countries and to a relatively low extent compared to fossil fuels. For example in Sweden many biomass fired CHP units date back to the decades from 1950 to 1980 and in Finland large biomass CHP capacities were constructed between 1993 and 2002. Multi-fuel burners could be an attractive option for biomass co-firing, particularly for steam boilers.

Regarding the **age distribution** of the capital stock the picture provided by the available data is incomplete. Only for furnaces in the iron and steel industry, CHP plants and some glass melting furnaces information about the construction year of individual plants was available.

However, for large industrial facilities, the construction year is not the only determinant of their efficiency. In practice, industrial plants are typically retrofitted and modernized without being completely replaced. Modernization for example allows using more efficient burners (e.g. replacing recuperative by regenerative burners) or using multi-fuel burners that provide more flexibility with regard to the heat used.

### 5.3 District heating and cooling

District heating systems for the heat supply in buildings and industry, as well as the share of district heat in the total heat supply, is very heterogeneous in Europe. The largest proportion of citizens served by district heating system can be found in Northern and Eastern European countries (see work package 1) with the highest share in Iceland (>90%), Latvia (~65%), Denmark (~63%) and Estonia (~62%). There is, however, no district heating in Cyprus, Ireland and Malta.

The countries with the highest installed thermal capacities are Poland (58 GW), Germany (49 GW) and the Czech Republic (24 GW). Denmark (23 GW), Iceland, Latvia and Estonia, in which the share of district heating in the heat supply is high, have comparably small installed capacities, due to the small population and size of the countries.

District heating systems also differ in their structure. Compared to the installed capacity, the trench length (length of district heating network) in Denmark, Sweden, Iceland and Finland is relatively large. This is because areas with a low population density are served with district heat in these countries. In most other countries analysed in chapter 4, it is primarily areas with relatively high population densities (urban areas) that are served by district heating systems, while only small capacities are installed in villages and other areas with low population densities.

The supply source of district heat (fossil/ renewable energy sources) is also highly variable between the analysed countries. In Iceland for example the district heat capacity is 100% renewable (Geothermal), while the share of renewable capacity in Estonia, Germany and Romania is very low. The use of solar thermal collectors and heat pumps is not yet widespread in Europe; it is only used in Denmark, Finland, Germany, Italy and Spain, and provides a small proportion of the installed thermal capacity. Nevertheless, the integration of heat pumps and solar thermal energy has increased in recent years and there are currently several efforts to increase the share of renewables and CHP in district heating systems. There are also attempts to reduce the heat losses in the heat supply grids by, for example, lowering the temperature level in the grid.

District cooling is so far only supplied in a few European countries and the installed thermal capacities are still low. There is only approximately 1.2 GW of installed thermal capacity across the whole of Europe with the highest capacity being installed in France (0.67 GW which represents more than 50% of the total installed capacity). Renewable energies are not yet widespread in the district cooling sector.

## 5.4 Recommendations

The investigation and data acquisition in WP 2 revealed the poor empirical basis for installed units and capacities of heating and cooling technologies in buildings in Europe. The empirical data on renewable heating technologies like heat pumps and biomass burning units are much more detailed than the data for fossil fuel technologies in all European countries. Data with the aspired level of detail were only available in a few countries. Most of the data gaps could be filled by using bottom-up models for estimation of the technology stock. The quantitative results of WP 2 are valid for the base year 2012. The developed methodology cannot be used to monitor future developments of the heating and cooling technology stock, but the data do provide a consistent basis for periodic updates.

The main gaps in the empirical data on heating and cooling technologies are:

- The sectoral split into households, industry and tertiary sectors for technologies used for space heating and hot water.
- Similarly for large CHP, the split between industry and district heating is not known by technology type (only on a very aggregated level from Eurostat).
- In most countries, there are only statistics on installed units, but not on the installed capacities of heating and cooling technologies.
- Virtually no empirical information is available for (industrial) steam boilers.
- The split into different capacities and age categories is usually not available.
- Hardly any country has empirical data on cooling technologies, especially in buildings.

In some countries (e.g. Germany) there are schemes which allow constant monitoring of installed heating technologies in terms of age, installed capacity and units. This monitoring is executed by chimney sweeps, for example, as there is a mandatory yearly inspection of chimneys. However, technologies which do not require chimneys (e.g. electrical heating systems) are not covered by these schemes. Expanding such schemes to cover all Member States and heating (and cooling) technologies could improve the empirical data basis tremendously. Another possible approach is to constantly update databases using sales statistics. For this purpose sales statistics would have to provide more details about the systems sold (at least capacities and units). The drawbacks of this approach are that it remains unknown whether the units sold are installed in new buildings or replace older technologies and if older units are replaced, there is no information about which technology is being replaced.

Similarly, safety inspections for steam boilers or insurance data could provide information on the stock and characteristics of existing technologies. These are, however, mostly for individual countries and difficult to access.

As described in the recommendations of WP 1, district heating statistics could be substantially improved by harmonizing the statistics on installed units supplying heat and their capacity. A critical point is that peak boilers installed together with a CHP plant are usually accounted for as CHP plants and are not listed separately. Statistics based on units rather than plants would improve data quality.

Despite the empirical data gaps and difficulties with the available statistics, most of the identified and described gaps can be closed by combining the available empirical data with the results from established and validated models.



## 6 Literature

- 4DH Research Centre, 4DH Research Centre. Strategic Research Centre for 4th Generation District Heating Technologies and Systems (4DH). Appendix B - Project description.
- Ademe, Agence de l'Environnement et de la maîtrise de l'énergie (2013): « Étude sur le chauffage domestique au bois : marchés et approvisionnement ». France
- ADHAC, 2014. Asociación de Empresas de Redes de Calor y Frío. Censo de Redes.
- ADHAC, 2015. R. González, Asociación de Empresas de Redes de Calor y Frío. Personal communication. 23 July 2015.
- Agureev, S.A. et al. (2013): Science for glass Production. Efficient control regimes for the thermal and technological process of glassmaking in tank furnaces for float-glass production. In: Glass and Ceramics. Online: <http://link.springer.com/article/10.1007/s10717-014-9578-1>. Accessed 13/10/2015
- AGFW, 2013. AGFW | Der Energieeffizienzverband für Wärme, Kälte und KWK e.V. (ed.). AGFW-Hauptbericht 2012.
- AIRU, 2013. Associazione Italiana Riscaldamento Urbano. Il riscaldamento urbano 2013.
- Ammermann, H., Hoff, P., Atanasiu, M., Aylor, J., Kaufmann, M., Tisler, O. (2015): Advancing Europe's energy systems: Stationary fuel cells in distributed generation. A study for the Fuel Cells and Hydrogen Joint Undertaking. Roland Berger Strategy Consultants.
- ANRE, 2013. Autoritatea Nationala de reglementare in domeniul energiei. Raportul Anual.
- Arens et al.(2012): Energy intensity development of the German iron and steel industry between 1991 and 2007. Karlsruhe, Germany.
- Arnemann, M., Schwarz, J., et. al. (unpublished): Kältetechnologien in Deutschland: Emissionen, Projektionen, Potenziale - Industrie, GHD, sonstige Anwendungen - Nahrungsmittelindustrie - Lebensmittelhandel - Wärmepumpen - Stationäre Klimatechnik; Hochschule Karlsruhe - Technik und Wirtschaft, noch unveröffentlicht
- Association of Producers of Ecological Energy (2013): « EurObserv'ER questionnaire on heat pumps sector for 2011 and 2012». Bulgaria, data collected in July 2013.
- ASUE (2011): BHKW-Kenndaten (2011): Module Anbieter Kosten, Berlin.
- Aydemir, A. et al. (2014a): Energy Saving Potentials for Industrial Steam Boilers - Findings from the Ecodesign Process. Proceedings of the 10<sup>th</sup> European Conference on Industrial Furnaces and Boilers (INFUB-10). Porto (Portugal), 7<sup>th</sup>-10<sup>th</sup> of April 2015.
- Aydemir, A.; Rohde, C. (2015b): Steam Boilers and the European Ecodesign process. Proceedings of the 2015 ACEEE industrial Summer Study on Energy Efficiency in Industry, pp. 2-1 to 2-13.
- Baillargeon, P., Michaud, N., Tossou, L. & Waide, E.P. (2011): Cooling Benchmarking Study, Part 1: Mapping Component Report, in partnership with clasp.

- Basis Bioenergy.eu project, European Biomass Association (AEBIOM) (2012): GIS about the large bioenergy plants in Europe. Consulted in June 2015
- BASREC, 2014. District Heating and Cooling, Combined Heat and Power and Renewable Energy Sources, 143 pp.
- BCG 2013: Steel's Contribution to a low-carbon Europe 2050. The Boston Consulting Group. Boston, USA
- Beletskii, B.I. et al. (2012): Analysis of sheet-glass Production in large-tonnage glassmaking furnaces. In: Glass and Ceramics. Online: <http://link.springer.com/article/10.1007/s10717-013-9465-1>. Accessed 15/10/2015
- Bergesen, C. (2014): UDI World electric power plants data base, Washington DC.
- BKI (2011): Kostenplaner 14 und BKI Baukostendatenbank 2011/2012 - Software zur sicheren Baukostenermittlung. Baukosteninformationszentrum Deutscher Architektenkammern BKI GmbH, Stuttgart.
- BmVit Bundesministerium für Verkehr, Innovation und Technologie (2015): « Innovative nergietechnologien in Österreich Marktentwicklung 2014 ». Austria
- Branger and Quirion (2015): Reaping the carbon rent: Abatement and overallocation profits in the European cement industry, insights from an LMDI, in: Energy Economics, Vol. 49, 189-205, 2015.
- Breidenbach, L., Leers, Frederic (Bundesverband der Deutschen Heizungsindustrie e.V. (BDH)) (2015): Gesamtbestand zentrale Wärmeezeuger Deutschland. Graphs via E-Mail, Cologne.
- Bremer Energie Institut; Fraunhofer ISI; IREES, Energieberatung GmbH (2011): Potenzialerhebung von Kraft-Wärme-Kopplung in Nordrhein-Westfalen, Bremen
- Brunke and Blesl (2014): Energy conservation measures for the German cement industry and their ability to compensate for rising energy-related production costs, in: Journal of Cleaner Production, Vol. 82, 94-111, 2014.
- Budapest University of Technology and Economics, Department of Environmental Economics (2015): HU Hungary - Country Page. Residential Building Typology. <http://episcope.eu/building-typology/country/hu/>. Accessed 28 July 2015.
- Building Research Establishment Ltd (Mr. Jack Hulme) (2015): EU project "Mapping and analyses of the current and future (2020-2030) heating and cooling fuel deployment (fossil/renewables)" - Heating technologies in the UK. E-Mail, Garston, Watford, Hertfordshire.
- Bundesamt für Statistik BFS (2015): Gebäude nach Heizungsart bzw. Energieträger der Heizung. Periode 2009-2013. [www.bfs.admin.ch/bfs/portal/de/index/themen/09/22/lexi.Document.139663.xls](http://www.bfs.admin.ch/bfs/portal/de/index/themen/09/22/lexi.Document.139663.xls). Accessed 29 July 2015.
- Bundesamt für Wirtschaft und Ausfuhrkontrolle BAFA (2014). Beim BAFA nach dem Kraft-Wärme-Kopplungsgesetz zugelassenen KWK-Anlagen ("Number of Combined Heat and Power plants admitted to BAFA according to the "Kraft-Wärme-Kopplungsgesetz" (act on combined heat and power generation)"). Tables via E-Mail, Eschborn.

- Bundesministerium für Verkehr, Bau und Stadtentwicklung BMVBS; Institut Wohnen und Umwelt (Darmstadt) (2012): Kosten energierelevanter Bau- und Anlagenteile bei der energetischen Modernisierung von Wohngebäuden. BMVBS-Online-Publikation 07/2012.  
[http://www.bbsr.bund.de/BBSR/DE/Veroeffentlichungen/BMVBS/Online/2012/DL\\_ON072012.pdf;jsessionid=949016A4AF57D4384EAB6AA56E2F3F95.live1041?\\_blob=publicationFile&v=2](http://www.bbsr.bund.de/BBSR/DE/Veroeffentlichungen/BMVBS/Online/2012/DL_ON072012.pdf;jsessionid=949016A4AF57D4384EAB6AA56E2F3F95.live1041?_blob=publicationFile&v=2). Accessed 9 September 2015.
- Bundesverband des Schornsteinfegerhandwerks – Zentralinnungsverband (ZIV), 2014. Erhebungen des Schornsteinfegerhandwerks - detaillierte Tabellen. Tables via E-Mail, Sankt Augustin.
- Burba, M. (2013): Improved energy efficiency of air cooled chillers. REHVA Journal, online available under: [http://www.rehva.eu/fileadmin/hvac-dictio/01-2013/Improved\\_energy\\_efficiency\\_of\\_air\\_cooled\\_chillers.pdf](http://www.rehva.eu/fileadmin/hvac-dictio/01-2013/Improved_energy_efficiency_of_air_cooled_chillers.pdf)
- Cembureau (2013): The role of cement in the 2050 low carbon economy, Brussels, 2013.
- Cembureau (2014): World statistical review 2001-2012 – cement production, trade, consumption data, Brussels, 2013.
- CEN (2000): Cement – Part 1: Compositions, Specifications and Conformity Criteria for Common Cements”, EN 197-1:2000, Brussels, 2000.
- Centre for Renewable Energy Sources and Saving (CRES) (2015): « EurObserv'ER questionnaire on heat pumps sector for 2011 and 2012». Greese, data collected in July 2013
- CEREN, Centre d'études et de recherches économiques sur l'énergie, 2015. « Répartition par usage des consommations des résidences principales (climat normal) ». France
- Clark, D. (2013): Information paper – 22: Chiller energy efficiency. Cundall Johnston & Partners LLP. Online available under: <http://www.cundall.com/Cundall/fckeditor/editor/images/UserFilesUpload/file/WCIYB/IP-22%20-%20Chiller%20energy%20efficiency.pdf>
- Climaespço, 2012.,ClimaespçoClimaespço. A rede de frio e calor do parque das Nações - Lisboa. Accessed 28 September 2015.  
<http://www.climaespaco.pt/images/BrochuraClimaespaco2012.pdf>.
- CODE2, 2013. Cogeneration Observatory and Dissemination Europe. Final CHP roadmap. Ireland.
- CODE2a, 2014. Cogeneration Observatory and Dissemination Europe. D5.1 - Final Cogeneration Roadmap. Non pilot Member State: Malta.
- CODE2b, 2014. Cogeneration Observatory and Dissemination Europe. D5.1 - Final Cogeneration Roadmap. Member State: Cyprus.
- CODE 2 (2015): European Cogeneration Roadmap. Cogeneration Observatory and Dissemination Europe (online access 2015/10/06: <http://www.code2-project.eu/wp-content/uploads/CODE-2-European-Cogeneration-Roadmap.pdf>)
- COGEN Europe (2013): European Cogeneration Review - The Netherlands, Brussels.
- Connolly, D., Mathiesen, B.V., Østergaard, P.A., Møller, B., Nielsen, S., Lund, H., Trier, D., Persson, U., Nilsson, D., Werner, S. (2012): Heat Roadmap Europe 2050. First pre-study for EU27. Euroheat & Power (Brussels); Aalborg University (Aalborg); Halmstad University (Halmstad), Brussels.

- Connolly, D., Mathiesen, B.V., Østergaard, P.A., Møller, B., Nielsen, S., Lund, H., Trier, D., Persson, U., Werner, S., Grözinger, J., Boermans, Thomas, Bosquet, Michelle (2013): Heat Roadmap Europe 2: Second Pre-Study for the EU27. Department of Development and Planning, Aalborg University (Aalborg).
- COWI, TI, DGC (2012): Technology Data for Energy Plants. Generation of Electricity and District Heating, Energy Storage and Energy Carrier Generation and Conversion.
- COWI, TI, DGC (2013): Technology Data for Energy Plants. Individual Heating Plants and Energy Transport, Copenhagen, Denmark.
- Crandall 1996: *"From competitiveness to competition – The threat of minimills to large steel companies"*, in: Resources Policy Vol. 22, pp. 107-118
- Crompton 2001: *"The diffusion of new steelmaking technology"*, in: Resources Policy 27, pp. 87-95
- Cross Border Bioenergy Project, « EU Handbook Small Scale Heating Markets (2013) », Brussels
- CSB, Central Statistical Bureau of the Republic of Latvia. Table ENG-16, Heat energy balance by statistical region.  
[http://data.csb.gov.lv/pxweb/en/vide/vide\\_\\_ikgad\\_\\_energetika/?tablelist=true&xid=cdbc978c-22b0-416a-aacc-aa650d3e2ce0](http://data.csb.gov.lv/pxweb/en/vide/vide__ikgad__energetika/?tablelist=true&xid=cdbc978c-22b0-416a-aacc-aa650d3e2ce0).
- CSI and WBCSD (2009): Development of State of the Art-Techniques in Cement Manufacturing: Trying to Look Ahead, Duesseldorf, Geneva, 2009.
- Czech Republic Ministry of Industry and Trade (2013): « EurObserv'ER questionnaire on heat pumps sector for 2011 and 2012». Czech Republic, data collected in July 2013.
- Dahlmann, et al. (2010): „Wege zur Effizienzsteigerung in der Stahlindustrie“, Düsseldorf. Danfoss (2016). The heating book - 8 Steps Control of heating systems. Chapter 5: Instructions for designing district heating systems.  
[http://heating.danfoss.com/pcmfiles/1/master/he/library/heating\\_book.asp](http://heating.danfoss.com/pcmfiles/1/master/he/library/heating_book.asp), downloaded 23.02.2016 16:13
- Danish Energy Agency (2015). Energy Statistics 2013. Data, tables, statistics and maps, Copenhagen, Denmark.
- Danish Energy Agency (2015): « EurObserv'ER questionnaire on heat pumps sector for 2011 and 2012». Danish, data collected in July 2013
- Dansk Fjernvarme, 2015. A. Jespersen. Personal communication. 8 July 2015.
- Darrow et al., 2015. K. Darrow, R. Tidball, J. Wang, A. Hampson. Catalog of CHP Technologies.
- Dengler, J., Fette, M., Henning, H.-M., Idrissova, F., Jochem, E., Kost, C., Reitze, F., Schick Tanz, M., Schnabel, L., Schulz, W., Steinbach, J. & Toro, F. (2011): Erarbeitung einer Integrierten Wärme- und Kältestrategie - Arbeitspaket 1 - Bestandsaufnahme und Strukturierung des Wärme- und Kältebereichs. Freiburg: 2011.
- Department of Energy & Climate Change (2015a): Combined heat and power: Chapter 7, Digest of United Kingdom Energy Statistics (DUKES).  
<https://www.gov.uk/government/statistics/combined-heat-and-power-chapter-7-digest-of-united-kingdom-energy-statistics-dukes>. Accessed 30 September 2015.

- Department of Energy & Climate Change (2015b): Monthly feed-in tariff commissioned installations by month. <https://www.gov.uk/government/statistics/monthly-small-scale-renewable-deployment>. Accessed 30 September 2015.
- Duvielguerbigny, Arnaud (Cogen Europe) (2015): CHP in Europe; CODE 2 Project. Tables and reports via E-Mail, Brussels.
- E.ON SE. Kraftwerk Irsching. <http://www.eon.com/de/ueber-uns/struktur/asset-finder/irsching.html>. Accessed 10 September 2015.
- ECCA 2012: *“Coil Coating: Sustainable Process, Sustainable Products”*, Brussels
- ECOHEATCOOL (2006): The European Cold Market. Final Report. Brussels, 2006.
- EEA (ed.) (2005): Characterization of the U.S. Industrial/Commercial Boiler Population. Energy and Environmental Analysis, Inc. Online: [http://www1.eere.energy.gov/manufacturing/distributedenergy/pdfs/characterization\\_industrial\\_commerical\\_boiler\\_population.pdf](http://www1.eere.energy.gov/manufacturing/distributedenergy/pdfs/characterization_industrial_commerical_boiler_population.pdf). Accessed: 13/08/2015.
- EEA b, 2013. Danko Aleksic. Municipal waste management in Latvia.
- EEA, European Environment Agency. The European Pollutant Release and Transfer Register. <http://prtr.ec.europa.eu/FacilityLevelsEPER.aspx>. Accessed August 2015.
- EGEC, 2013. European Geothermal Energy Council. EGEN Market Report 2013/2014.
- EGEC, 2015. P. Dumas, European Geothermal Energy Council. Personal communication. 2 July 2015.
- EIHP, 2015. B. Vuk, Energy Institute Hrvoje Pozar. Personal communication. 17 July 2015.
- Einstein, D.; Worrell, E.; Khrushch, M. (2001): Steam systems in industry: Energy use and energy efficiency improvement potentials. Lawrence Berkeley National Laboratory. Online: <http://escholarship.org/uc/item/3m1781f1>. Accessed: 22/10/2013.
- Enerdata (2015): Odyssee database, Paris, 2015.
- Energetics; E3M (ed.) (2004): Energy Use, Loss and Opportunities Analysis: U.S. Manufacturing & Mining. Report for U.S. Department of Energy. Online: [http://energy.gov/sites/prod/files/2013/11/f4/energy\\_use\\_loss\\_opportunities\\_analysis.pdf](http://energy.gov/sites/prod/files/2013/11/f4/energy_use_loss_opportunities_analysis.pdf). Accessed: 14.08.2015.
- Energinet.dk (2012): Technology data for energy plants: Generation of Electricity and District Heating, Energy Storage and Energy Carrier Generation and Conversion.
- Energy Centre Bratislava (2013): . « EurObserv'ER questionnaire on heat pumps sector for 2011 and 2012». Slovakia, data collected in July 2013.
- Energy Economics Group (EEG) (2015): Model results INVERT/ EE-Lab based on ENTRANZE project. Email, Vienna.
- ENS, 2015. O. Odgaard, Danish Energy Agency. Personal communication. 16 September 2015.
- EPA (ed.) (2010): Available And Emerging Technologies for Reducing Greenhouse Gas Emissions From The Petroleum Refining Industry. United States Environmental Protection Agency (EPA). Online: <http://www.epa.gov/nsr/ghgdocs/refineries.pdf>. Accessed: 14/08/2015.
- EPA 2012: *“Available and emerging Technologies for reducing Greenhouse Gas Emissions from the Iron and Steel Industry”*

- EPHA, 2015. A. Veske, Estonian Power and Heat Association. Personal communication. 8 September 2015.
- Erdmann, G., Dittmar, L. (2010): Technologische und energiepolitische Bewertung der Perspektiven von Kraft-Wärme-Kopplung in Deutschland, Berlin.
- Erhebungen des Schornsteinfegerhandwerks für 2013.
- ETSAP (ed.) (2010): ETSAP Energy Technology Systems Analysis Programme. Industrial Combustion Boilers. IEA ETSAP. Online: [http://www.etsap.org/E-techDS/PDF/I01-ind\\_boilers-GS-AD-gct1.pdf](http://www.etsap.org/E-techDS/PDF/I01-ind_boilers-GS-AD-gct1.pdf). Accessed: 13.08.2015.
- ETSAP, IEA (2010): Coal Fired Power. Technology Brief, IEA ETSAP
- ETSAP, IEA (2010): Gas Fired Power. Technology brief, IEA ETSAP
- ETSAP, IEA (2010): Industrial Boilers. Technical Report, London: IEA-ETSAP/EurObserv'ER Barometer project (2013): « 2012 EurObserv'ER barometer on the european heat pump sector, September 2013 », Paris
- Euroconstruct (2013): Wohnungsfertigstellungen je 1.000 Einwohner von 1991 -2013, via email conversation, 2013.
- Euroheat & Power (2015): District heating and cooling. Country by country - 2015 survey, 378 pp.
- Euroheat and power (2014): District heating and cooling statistics
- Euroheat & Power b. Statistics overview 2011. <http://www.euroheat.org/DHC---Statistics-4.aspx>.
- Euroheat & Power c. Statistics overview 2009. <http://www.euroheat.org/DHC---Statistics-4.aspx>.
- European Biomass Association (AEBIOM) (2010): « Outlook on Market Segments for Biomass Uptake by 2020 ». EU25
- European Biomass Association (AEBIOM) (2014): « European Wood chips plants Country analysis».
- European Biomass Association (s) (2014): « European Bioenergy Outlook, report 2014 », Brussels
- European Commission (2007): Lot 12 Commercial refrigerators and freezers Final Report. Preparatory Studies for Eco-design Requirements of EuPs [TREN/D1/40-2005/LOT12/S07.56644], Brussels, 2007.
- European Commission (2008): Energy Sources, Production Costs and Performance of Technologies for Power Generation, Heating and Transport,. European Commission, 2008.
- European Commission (2009): IPPC Reference Document on Best Available Techniques for Energy Efficiency.
- European Commission (2010): Reference Document on Best Available Techniques in the Cement, Lime and Magnesium Oxide Manufacturing Industries. Integrated Pollution Prevention and Control. Sevilla, 2010.
- European Commission (2011): ENTR-Lot 1 Refrigerating and Freezing equipment. Preparatory Studies for Eco-design Requirements of EuPs [Contract N° S12.515749], Brussels, 2011.

- European Geothermal Energy Council (EGEC) (2013/2014): « EGEC Market Report 2013/2014 », Brussels
- European Geothermal Energy Council (EGEC) (2015): data about geothermal heat pumps market in Europe in 2012. EU28, collected in July 2015
- European Heat Pumps association (EHPA) (2015): data about aerothermal and geothermal heat pumps market in Europe in 2012. EU28, collected in July 2015
- European heat pumps association (EHPA)(2014): “European Heat Pump Market and Statistics, report 2014”, Brussels.
- European Pellet Council (EPC) (2014): « Overview of the European pellet Market, May 2014 », Brussels
- Eurostat (2014): GDP and main components [nama\_gdp\_k]. Online: <http://ec.europa.eu/eurostat>. Extracted on 29.07.2014.
- Eurostat (2015): Population data, Brussels, 2015.
- Eurostat (2015a): Purchasing power parities (PPPs), price level indices and real expenditures for ESA2010 aggregates [prc\_ppp\_ind]. Machinery and equipment. Online: <http://ec.europa.eu/eurostat>. Extracted on 17.08.2015.
- Eurostat (2015b): Annual detailed enterprise statistics for industry (NACE Rev. 2, B-E) [sbs\_na\_ind\_r2]. Number of employees in full time equivalent units. Online: <http://ec.europa.eu/eurostat>. Extracted on 17.08.2015.
- Eurostat (2015c): Simplified energy balances - annual data [nrg\_100a]. Online: <http://ec.europa.eu/eurostat>. Extracted on 17.08.2015.
- Eurostat (2015d): Combined heat and power (CHP) data. Online: <http://ec.europa.eu/eurostat/documents/38154/4956229/CHP+data+2005-2013/62e87958-0b9a-4195-af70-356493e12233> (extracted 2015/10/11)
- Eurostat; Ministerio de Industria, Energia y Turismo, IDAE (2011): Análisis del consumo energético del sector residencial en España. Informe final.
- FGW, 2015. K. Griessmair, Association of Gas- and District Heating Supply Companies. Personal communication. 13 July 2015.
- Finnish Energy Industries, 2013. Finnish Energy Industries (FE). District Heating in Finland 2012.
- Finnish Energy Industries, 2015. A. Kohopaa. Personal communication. July 2015.
- Finnish heat pumps association (SULPU) (2013): « EurObserv'ER questionnaire on heat pumps sector for 2011 and 2012 ». Slovenia, data collected in July 2013.
- Fleiter, T. et al. (2013): Energieverbrauch und CO<sub>2</sub>-Emissionen industrieller Prozesstechnologien – Einsparpotentiale, Hemmnisse und Instrumente. Stuttgart
- Fraunhofer IFAM, IREES, BHKW Infozentrum, Prognos (2014): Potenzial- und Kosten-Nutzen-Analyse zu den Einsatzmöglichkeiten von Kraft-Wärme-Kopplung (Umsetzung der EU-Energieeffizienzrichtlinie) sowie Evaluierung des KWKG im Jahr 2014
- Friscado (2008): Leistungszahlen für Kälte-, Klima- und Wärmepumpensysteme

- Garcia N. P., Vatopoulos, K., Riekkola, A.K., Lopez, A.P. & Olsen, L. (2012): Best available technologies for the heat and cooling market in the European Union, JRC Scientific and Policy Reports, EU Commission, Setis – Information For Decision-making, online available under:  
<http://publications.jrc.ec.europa.eu/repository/bitstream/JRC72656/eur%2025407%20en%20-%20heat%20and%20cooling%20final%20report-%20online.pdf>
- Gentili, P. et al. (2014): Ecodesign Preparatory Study on Steam Boilers (ENTR Lot 7). Online: <http://www.eco-steamboilers.eu/eco-steamboilers-wAssets/docs/20141217-Steam-Boilers-Ecodesign-Final-Report.pdf>. Accessed: 13/08/2015.
- German Association of Refrigerated Products and German Institute for Refrigerated Products, Statistics and personal interview, <http://www.tiefkuehlkost.de/>
- Giesler, Silke (statista GmbH) (2015): Heizungstechnologien Frankreich. Email, Hamburg.
- Gradbeni inštitut ZRMK d.o.o. (2014): SI Slovenia - Country Page. Residential Building Typology. <http://episcopo.eu/building-typology/country/si/>. Accessed 27 July 2015.
- Grein, A., Pehnt, M., Duscha, M. & Kellerbauer, H. (2009): Modellstadt Mannheim – Nutzung von thermischen Speichern als Energiespeichern. 2009.
- Henning, H.M. (2012): Erarbeitung einer Integrierten Wärme- und Kältestrategie. Arbeitspaket 8 – Handlungsempfehlungen. Fraunhofer-Institut für Solare Energiesysteme. Freiburg 2012
- HVAC Hess Heating, Ventilation & Air-Conditioning High Efficiency Systems Strategy: Factsheet Chiller Efficiency, online available under:  
<http://www.industry.gov.au/Energy/EnergyEfficiency/Non-residentialBuildings/HVAC/FactSheets/Documents/HVACFSSChillerEfficiency.pdf>
- IAEA, 2013. International Atomic Energy Agency. IAEA Annual Report 2012.
- Ibp Inc., 2015. Romania energy policy, laws and regulations handbook : strategic information and basic laws. Volume 1 Strategic Information and Basic Laws.
- IEA (2011): Technology Roadmap 2050 – Energy-efficient Buildings: Heat and Cooling equipment.
- IEA (2007): Tracking Industrial Energy Efficiency and CO2 Emissions, IEA/OECD, Paris, 2007.
- IEA (2008): Combined heat and power – Evaluating the benefits of greater global investment. International Energy Agency: Paris
- IEA (2009): Energy technology transitions for industry – Strategies for the next industrial revolution, Paris, 2009.
- IEA (2015): “*Frequently Asked Questions*”, available at:  
<http://www.iea.org/statistics/resources/questionnaires/faq/>, last visited 8/21/2015
- IEA-ETSAP (2010a): Biomass for Heat & Power. London: International Energy Agency, 2010.
- IEA-ETSAP (2010b): Combined Heat and Power. London: International Energy Agency, 2010.
- IEA-ETSAP, IRENA (2013): Biomass Co-firing. Technology Brief. London: International Energy Agency, 2013.



- Industrial Efficiency Technology Database: “*Electric Arc Furnace*”, available at: <http://ietd.iipnetwork.org/content/electric-arc-furnace>, last visited 8/21/2015.
- Intergovernmental Panel on Climate Change (IPCC) (2007): *Climate Change 2007 - Mitigation of Climate Change: Working Group III contribution to the Fourth Assessment Report of the IPCC (Climate Change 2007)*, IPCC, Cambridge University Press.).
- International Energy Agency (2010): *Energy Technology Perspectives. Scenarios & Strategies to 2050*. International Energy Agency, Paris, 458 pp.
- IPPC (2013): *Best available Techniques (BAT) Reference Document for the Manufacture of Glass*. Online: [http://eippcb.jrc.ec.europa.eu/reference/BREF/GLS\\_Adopted\\_03\\_2012.pdf](http://eippcb.jrc.ec.europa.eu/reference/BREF/GLS_Adopted_03_2012.pdf). Accessed: 15/10/2015
- IPPC (Bureau 2006): *Best Available Techniques for Large Combustion Plants. Reference Document*, European Commission, 2006.
- IPPC. (Bureau, 2006): *Reference Document on the Best Available Techniques for Waste Incineration*. Seville: European Commission - IPPC Bureau, 2006.
- IPPC. (Bureau, 2009): *Reference Document on the Best Available Techniques for Energy Efficiency*. Seville: European Commission - IPPC Bureau, 2009.
- Jarn 2014, *Japan Air Conditioning, Heating and Refrigeration News, 2014: World Compressor Market 2014*.
- Jarn 2015, *Japan Air Conditioning, Heating and Refrigeration News, 2015: World Compressor Market 2015*.
- Jochem, E. et al. (2004): *Werkstoffeffizienz. Einsparpotentiale bei Herstellung und Verwendung energieintensiver Grundstoffe*. Stuttgart
- Jofra Sora, M. (2013). M. Jofra Sora. *Incineration overcapacity and waste shipping in Europe: the end of the proximity principle?*
- Jozef Stefan Institute (2013): «*EurObserv'ER questionnaire on heat pumps sector for 2011 and 2012*». Slovenia, data collected in July 2013.
- Karagiannidis. *Waste to Energy: Opportunities and Challenges for Developing and Transition Economies*.
- Klee et al. (2011): *Getting the numbers right: a database of energy performance and carbon dioxide emissions for the cement industry.* "Greenhouse Gas Measurement & Management, Vol. 1, 109-118, 2011.
- Knezevic, Vanesa (European Heating Industry (EHI)), 2015. *Heating technologies in Europe*. Tables via E-Mail, Brussels.
- Kramer, K. J. et al. (2009): *Energy Efficiency Improvement and Cost Saving Opportunities for the Pulp and Paper Industry. An Energy Star(R) Guide for Energy and Plant Managers*. Ernest Orlando Lawrence Berkeley National Laboratory. Environmental Energy Technologies Division. LBNL-2268E. Online: [http://www.energystar.gov/ia/business/industry/downloads/Pulp\\_and\\_Paper\\_Energy\\_Guide.pdf](http://www.energystar.gov/ia/business/industry/downloads/Pulp_and_Paper_Energy_Guide.pdf). Accessed: 14/08/2015.
- Lako, 2010. P. Lako. *Combined Heat and Power*.
- Lasselle (2013): *Sectoral model of the cement industry using input-output analysis*, Norwegian University of Science and Technology, 2013.
- László S., et al. (2003): *Energy consumption and CO2 emissions from the world cement industry*, <http://www.jrc.es>, 2003.

- LDHA, 2015. R. Gurklienė, Lithuanian District Heating Association. Personal communication. 29 July 2015.
- Levitin et al. (2012): Efficiency and Quality. Increase of glass manufacturing efficiency using cullet in float-glass production. In: Glass and Ceramics. Online: <http://link.springer.com/article/10.1007/s10717-012-9432-2>. Accessed 16/10/2015
- Lucas K.; Gebhardt, M.; Kohl, M. Steinrötter, T. (2002): Preisatlas. Ableitung von Kostenfunktionen für Komponenten der rationellen Energienutzung.
- Madlool, N.A.; Saidur, R.; Hossain, M.S.; Rahim, N.A.; (2011): A critical review of energy use and savings in the cement industries, in: Renewable and Sustainable Energy Reviews, Vol. 15, 2042-2060, 2011.
- Matthes, Felix Christian; Ziesing, Hans-Joachim (2011): Wirtschaftlichkeit von Kraft-Wärme-Kopplungs-Anlagen. Band 1: Der Wirtschaftlichkeitsindikator COGIX – Methodenband. Studie für den VKU, Berlin
- Mauthner, F., Weiss, W., Spörk-Dür, M. (2015): Solar Heat Worldwide, Gleisdorf.
- McCaffrey, R.; Brown, P. (2013): Global Cement Directory 2013, UK, 2013.
- Mercato del riscaldamento e della climatizzazione nei settori residenziale e terziario, March 2015, Milano.
- Midrex 2007: "MIDREX Technology Development", available at: <http://www.midrex.com/news-literature/technical-papers-brochures/midrex-dri-technology>, last visited 8/21/2015
- Mikulandrić et al., 2014. Potential of district heating systems in Eastern. 1st South East European Conference on Sustainable Development of Energy, Water and Environment Systems, 29 June 2014, Ohrid, Republic of Macedonia.
- Ministry of Economic Development (2013): « EurObserv'ER questionnaire on heat pumps sector for 2011 and 2012». Italy, data collected in July 2013
- Moya, Pardo 2013: "The potential for improvements in energy efficiency and CO<sub>2</sub> emissions in the EU27 iron and steel industry under different payback periods", Journal of Cleaner Production 52, pp. 71-83
- Narodowa Agencja Poszanowania Energii SA NAPE (2012): PL Poland - Country Page. Residential Building Typology. <http://episcope.eu/index.php?id=201>. Accessed 27 July 2015.
- NFV, 2015. H. Juhler, Norsk Fjernvarme. Personal Communication. 4 August 2015.
- Observ'ER (2013): « Suivi du marché 2012 des appareils de chauffage domestiques au bois, 2013 », Paris
- Oda et al. (2012): International comparison of energy efficiency in power, steel, and cement industries, in: Energy Policy, Vol. 44, 118-129, 2012.
- Odisha Posco 2005: "MEMORANDUM OF UNDERSTANDING BETWEEN THE GOVERNMENT OF ORISSA AND M/s POSCO FOR ESTABLISHMENT OF AN INTEGRATED STEEL PLANT AT PARADEEP", Bhubaneswar 2005
- OECD 2015: "Excess Capacity in the Global Steel Industry and the Implications of New Investment Projects", *OECD Science, Technology and Industry Policy Papers*, No. 18, OECD Publishing. <http://dx.doi.org/10.1787/5js65x46nxhj-en>
- PellCert european project, AIEL – Italian Agriforestry Energy Association (2011): « Italy - pellet report ». Italy, Accessed ind June 2015

- PellCert european project, AveBiom (2011): « Spain - pellet report ». Spain
- PellCert european project, Finnish pellet energy association (2011): « Finland - pellet report ». Finland
- PellCert european project, German Wood Fuel and Pellet Association (2011): « Germany - pellet report ». Germany
- PellCert european project, Hungarian pellet association (2011): « Hungary - pellet report ». Hungary
- PellCert european project, Propellet Austria (2011): « Austria - pellet report ». Austria
- PellCert european project, Propellet France (2011): « France - pellet report ». France
- PellCert european project, Svebio (2011): « Sweden - pellet report ». Sweden
- PellCert european project, ValBiom (2011): « Belgium - pellet report ». Belgium
- Persson, Urban, 2015. District heating in future Europe: Modelling expansion potentials and mapping heat synergy regions. Thesis for the degree of Doctor of Philosophy, Gothenburg, Sweden, 109 pp.
- Pfafferott J (2003): « Passive Kühlung mit Nachtlüftung ». BINE Themeninfo I/2003
- Polska Organizacja Rozwoju Technologii Pomp Ciepła (PORT PC) (2013): « EurObserv'ER questionnaire on heat pumps sector for 2011 and 2012». Poland, data collected in July 2013.
- Posco 2015: *“Construction completed on new plant in India for cold rolled steel plate plant for luxury cars”*, press release (Feb. 02, 2015), available at: <http://www.posco.co.kr/homepage/docs/eng5/jsp/prcenter/news/s91c10100151.jsp?mdex=posco38>, last visited 9/10/2015
- Radgen, P. (2008): *Rationelle Energieanwendung in der Industrie*. Koblenz-Landau 2008
- Reitze, F. (2012): *Endenergiebedarf zur Prozesskälteerzeugung, Effizienzpotentiale sowie hemmende Faktoren für den Einsatz effizienter Kältetechnologien im GHD-Sektor und bei milchproduzierenden Betrieben in Deutschland*. Masterthesis. Universität Koblenz. 2012
- RESCUE, 2012./2013. *Rescue Renewable Smart Cooling for Urban Europe*. Work Package 2 EU District Cooling Market and Trends.
- Rescue Workpackage 2: *District cooling and the customers' alternative cost*. Online available under: [http://www.rescue-project.eu/fileadmin/user\\_files/WP2\\_Reports/RESCUE\\_WP\\_2.2\\_ENVIRONMENTAL\\_FACTORS.pdf](http://www.rescue-project.eu/fileadmin/user_files/WP2_Reports/RESCUE_WP_2.2_ENVIRONMENTAL_FACTORS.pdf)
- Rohde, C.; Ostrander, B.; Hirzel, S.; Aydemir, A. et al. (2014): *An insight in the ecodesign process – the example of steam boilers*. Proceedings of the 2014 eceee industrial summary study, 2-5<sup>th</sup> of June, Arnhem, Netherland, pp. 449-460.
- Schaeffer, H. (2014): *Werkstoff Glas. Alter Werkstoff mit großer Zukunft*. Berlin
- Schneider, M.; Romer, M.; Tschudin, M.; Bolio, H. (2011): *Sustainable cement production-present and future*, in: *Cem. Concr. Res.*, Vol. 41, 642–650, 2011.

- Schott et al. 2012: „Effizienzsteigerung des Reduktionsmitteleinsatzes im Hochofen zur CO<sub>2</sub>-Minderung und Kosteneinsparnis“. in: Chemie Ingenieur Technik 2012, 84, No.7, pp. 1076-1084. DOI: [10.1002/cite.201100224](https://doi.org/10.1002/cite.201100224)
- Schramek, E.-R. (Ed.) (2011): Taschenbuch für Heizung und Klimatechnik. einschließlich Warmwasser- und Kältetechnik, 75th ed. Oldenbourg Industrieverlag GmbH, München, 2391 pp.
- SDH, Solar District Heating. Solar heating plants database. <http://www.solar-district-heating.eu/ServicesTools/Plantdatabase.aspx>.
- SHARES Renewables database – Eurostat (2015): <http://ec.europa.eu/eurostat/web/energy/data/shares>. Consulted in June 2015
- Siemens (2011): “SIMETAL EAF Quantum”, Willstätt-Legelshurst
- SNCU, Syndicat national du chauffage urbain et de la climatisation urbaine. Enquete Nationale sur les Reseaux de Chaleur et de Froid. Restitution des statistiques portant sur l’annee 2012.
- Sofia Energy Agency - SOFENA (2012): BG Bulgaria - Country Page. Residential Building Typology. <http://episcopo.eu/index.php?id=211>. Accessed 18 August 2015.
- Sofia Energy Agency - SOFENA (2012): BG Bulgaria - Country Page. Residential Building Typology. <http://episcopo.eu/index.php?id=211>. Accessed 18 August 2015.
- Stahlinstitut VDEh (2015): “PlantFacts Database” (commercial), Düsseldorf.
- Statistics Lithuania (2013): « EurObserv’ER questionnaire on heat pumps sector for 2011 and 2012». Lithuania, data collected in July 2013
- Statistics Luxembourg, Statec (2013): « EurObserv’ER questionnaire on heat pumps sector for 2011 and 2012». Luxembourg, data collected in July 2013
- Statistics Netherlands (CBS) (2013): « EurObserv’ER questionnaire on heat pumps sector for 2011 and 2012 ». Slovenia, data collected in July 2013.
- Statistics Norway. Balance of district heating. Accessed 1 July 2015. <https://www.ssb.no/en/energi-og-industri/statistikker/fjernvarme/aar/2014-10-14?fane=tabell&sort=nummer&tabell=200984>.
- Statistics Sweden. Electricity supply, district heating and supply of natural and gas-works gas 2012.
- Statistik Austria - Bundesanstalt Statistik Österreich (2013): Energieeinsatz der Haushalte. Heizungen 2003 bis 2012 nach Bundesländern, verwendetem Energieträger und Art der Heizung. [http://www.statistik.at/web\\_de/statistiken/energie\\_umwelt\\_innovation\\_mobilitaet/energie\\_und\\_umwelt/energie/energieeinsatz\\_der\\_haushalte/index.html](http://www.statistik.at/web_de/statistiken/energie_umwelt_innovation_mobilitaet/energie_und_umwelt/energie/energieeinsatz_der_haushalte/index.html). Accessed 22 July 2015.
- Steelonthenet2015: “Electric Arc Furnace Steelmaking Costs 2015”, available at: <http://www.steelonthenet.com/cost-eaf.html>, last visited: 9/11/2015
- STÚ-K, a. (2015): CZ Czech Republic - Country Page. Residential Building Typology. <http://episcopo.eu/building-typology/country/cz/>. Accessed 18 August 2015.
- Suopajarvi (2013): “Bioreducer – Possibilities of bio-based materials in reduction applications”, Oulu (Finland).
- SURS, Statistical Office of the Republic of Slovenia. Balance of Heat. [http://pxweb.stat.si/pxweb/Database/Environment/18\\_energy/05\\_18177\\_heat/05\\_18177\\_heat.asp](http://pxweb.stat.si/pxweb/Database/Environment/18_energy/05_18177_heat/05_18177_heat.asp).

- SVK, 2012: Elektrizitätsbedarf für Kühlen in der Schweiz, Kampagne effiziente Kälte, Zürich, September 2012.
- Swagelok (2011): Steam System Thermal Cycle Efficiency – Part One. Steam Systems Best Practices. Document No. 33. Swagelok Energy Advisors, Inc.
- Swedish Energy Agency (Westin, Paul) (2015): Heating Technology in Sweden. E-Mail, Phone call, Eskilstuna.
- Swedish Heat pump association (SVEP) (2013): « Heat pumps market development in Sweden for small HP, 2012 », Sweden
- Swedish heat pumps association (2012): « GCHP Market Development in Sweden for small HP ». Sweden
- Syndicat des industries thermiques, aérauliques et frigorifiques (UNICLIMA) (2012): « Bilan 2012 du génie climatique, 2013 », Paris
- Therkelsen, P.; McKane, A. (2013): Implementation and rejection of industrial steam system energy efficiency measures. In: Energy Policy, 57, pp. 318-328.
- The Indian Express 2015: “Posco, Uttam Steel and Power to set up `20K crore plant in Maharashtra”, press article, available at: <http://indianexpress.com/article/business/business-others/posco-uttam-steel-and-power-to-set-up-20k-crore-plant-in-maharashtra/>, last visited 9/10/2015
- ThyssenKrupp Steel Europe 2007: “Hochofen 8”, press release, available at: [http://www.thyssenkrupp.com/de/presse/bilder.html&photo\\_id=756](http://www.thyssenkrupp.com/de/presse/bilder.html&photo_id=756), last visited: 9/10/2015
- TU Delft (2013): NL The Netherlands - Country Page. Residential Building Typology. <http://episcope.eu/building-typology/country/nl/>. Accessed 27 July 2015.
- UBA (2015): Sustainable cooling supply for building air conditioning and industry in Germany. Dessau-Roßlau, April 2015
- UBA (2013): Kraft-Wärme-Kopplung. <http://www.umweltbundesamt.de/daten/energiebereitstellung-verbrauch/kraft-waerme-kopplung>. Accessed 5 June 2014.
- University of Miskolc (2013): « EurObserv’ER questionnaire on heat pumps sector for 2011 and 2012 ». Hungary, data collected in July 2013.
- US EPA (2015): Catalog of CHP technologies, U.S. Environmental Protection Agency Combined Heat and Power Partnership
- US DOE (ed.) (2012): Improving Steam System Performance: A Sourcebook for Industry. Second edition. United States Department of Energy. Online: <http://energy.gov/sites/prod/files/2014/05/f15/steamsourcebook.pdf>. Accessed: 13/08/2015.
- van Campenhout, K. (2015): EU project “Mapping and analyses of the current and future (2020-2030) heating and cooling fuel deployment (fossil/renewables)” - Technology stock in Belgium. Email, Brussels.
- VDEh2015: Stahl und Nachhaltigkeit – Eine Bestandsaufnahme in Deutschland. Stahlinstitut VdEh. Available at: [http://www.stahl-online.de/wp-content/uploads/2013/12/Stahl\\_Nachhaltigkeit\\_2015\\_web.pdf](http://www.stahl-online.de/wp-content/uploads/2013/12/Stahl_Nachhaltigkeit_2015_web.pdf). accessed: 18/02/2016
- VDMA (2011): Energiebedarf für Kältetechnik in Deutschland. Eine Abschätzung des Energiebedarfs von Kältetechnik in Deutschland nach Einsatzgebieten. Frankfurt

am Main, 17.03.2011

- VDZ (2012): Tätigkeitsbericht 2009-2012, Duesseldorf 2012.
- Verallia (2015): Im Test: Biogas für die Glasschmelze. Press release. Online:  
<http://de.verallia.com/im-test-biogas-fuer-die-glasschmelze/%5Btitle-raw%5D>.  
Accessed 10/10/2015
- Volz, F. (2012): Bundesmessprogramm zur Weiterentwicklung der kleintechnischen Biomassevergasung. ZAE Bayern; DBFZ Deutsches Biomasseforschungszentrum gemeinnützige GmbH, Garching.
- Waide., P., Rieviere, P. & Watson, R. (2011): Cooling Benchmarking Study, Part 2: Mapping Component Report
- Watanabe, C. (2015). Ene-Farms use hydrogen to power homes but don't come cheap. Bloomberg Businessweek.  
<http://www.bloomberg.com/news/articles/2015-01-15/fuel-cells-for-homes-japanese-companies-pitch-clean-energy>. Accessed 28 October 2015.
- WBCSD (2009a): Cement Technology Roadmap 2009 – Carbon emissions reductions up to 2050, Switzerland, 2009.
- WBCSD (2009b): The cement sustainability initiative – getting the numbers right – report explaining the purpose and function of the GNR database. Technical Report, Switzerland, 2009.
- Wees et al. (1986): *“Energy Consumption for Steel Production”*, Report to World Energy Conference, Cannes
- Wen et al. (2015): Evaluation of energy saving potential in China’s cement industry using the Asian-Pacific Integrated Model and the technology promotion policy analysis, in: *Energy Policy*, Vol. 77, 227-237, 2015.
- Wenzel, B., Nitsch, J., Pregger, T., Scholz, Y., Naegler, T., Sterner, M., Gerhardt, N., Oehsen, A.v., Pape, C., Saint-Drenan, Y.-M. (2010): Langfristszenarien und Strategien für den Ausbau der erneuerbaren Energien in Deutschland bei Berücksichtigung der Entwicklung in Europa und global "Leitstudie 2010". Datenanhang II. Deutsches Zentrum für Luft- und Raumfahrt DLR (Stuttgart); Fraunhofer Institut für Windenergie und Energiesystemtechnik (Kassel); Ingenieurbüro für neue Energien (Teltow), Stuttgart, Kassel, Teltow. Accessed 9 September 2015.
- Wiemken, E., Morgenstern, A., Schicktanz, M., Nienborg, B. (2013): Planungsleitfaden Solare Kühlung, Freiburg.
- Worldsteel Association (2013): *“Steel Statistical Yearbook 2013”*, Brussels
- Worldsteel Committee on Economic Studies (2013): *“Steel Statistical Yearbook 2012”*, Brussels.
- Worrell E.; Galitsky, C.; Masanet, E.; Graus, W. (2008): Energy Efficiency Improvement and Cost Saving Opportunities for the Glass industry. An ENERGY STAR Guide for Energy and Plant Managers. Online:  
<http://www.energystar.gov/ia/business/industry/Glass-Guide.pdf>. Accessed: 16/10/2015
- Worrell E.; Galitsky, C.; Masanet, E.; Graus W. (2010): Energy Efficiency Improvement and Cost Saving Opportunities for the U.S. Iron and Steel Industry. Berkeley 2015
- Yoshiyuki et al. 2005: *“The Principle of Blast Furnace operational Technology and Centralized Gas Flow by Center Coke Charging”*, Kobelco Technology Review 26

Zentrum für Sonnenenergie- und Wasserstoff-Forschung Baden-Württemberg (ZSW),  
(2013): « EurObserv'ER questionnaire on heat pumps sector for 2011 and 2012».  
Germany, data collected in July 2013.

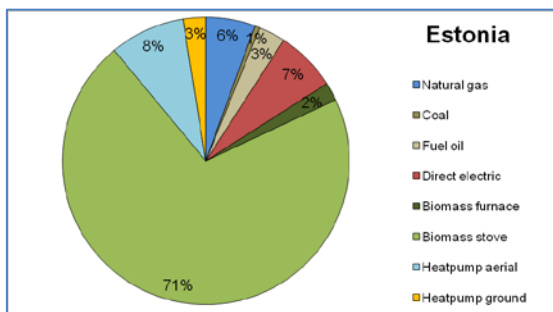
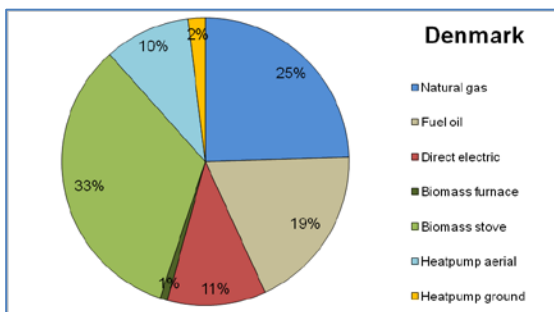
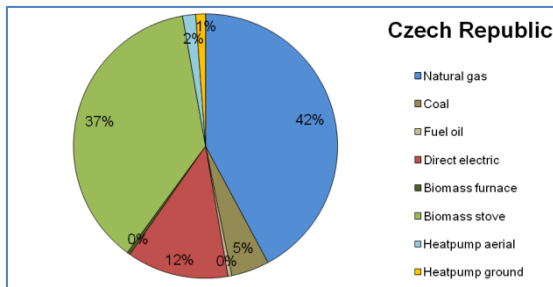
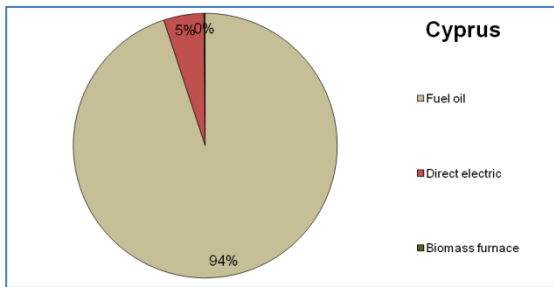
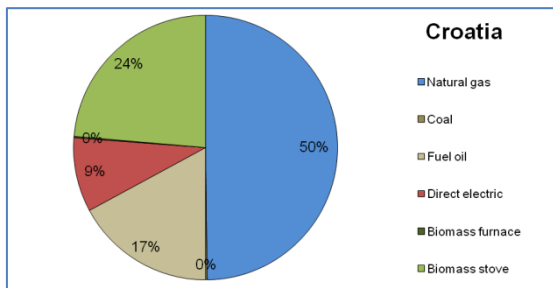
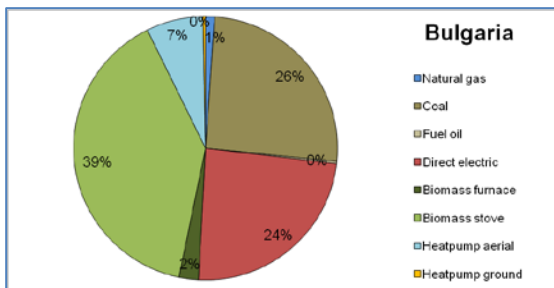
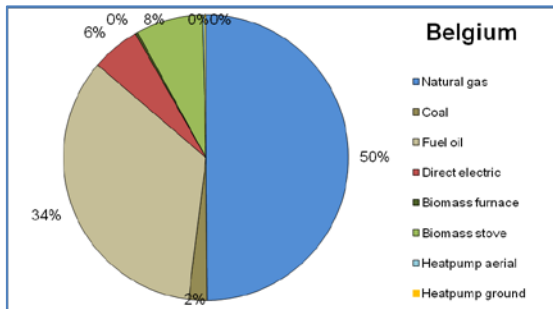
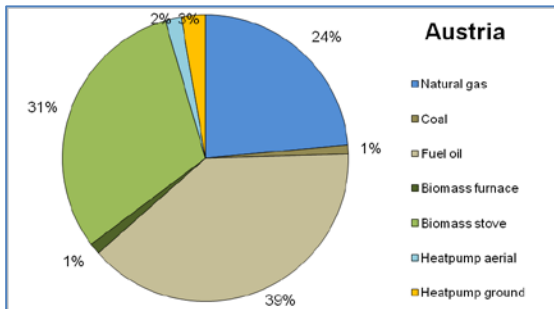
## **7 Annex**

### **7.1 Share of individual heating technologies by country in buildings**

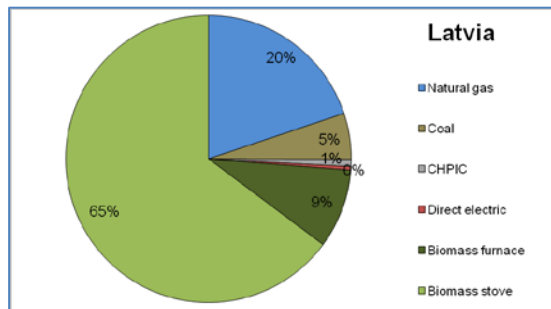
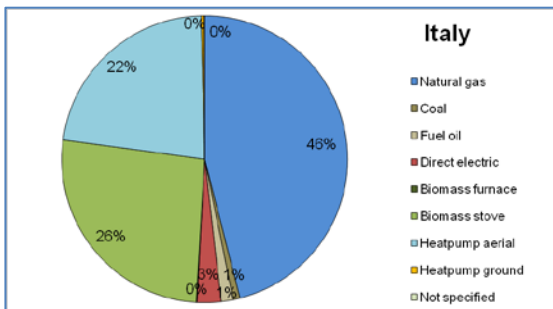
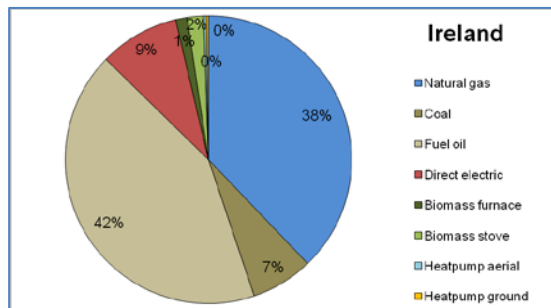
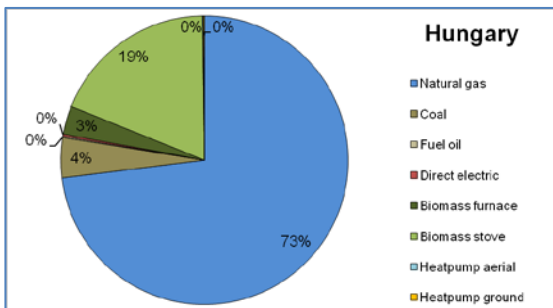
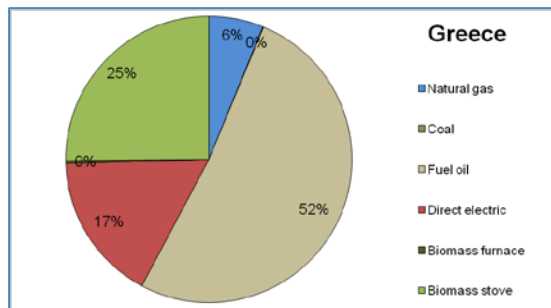
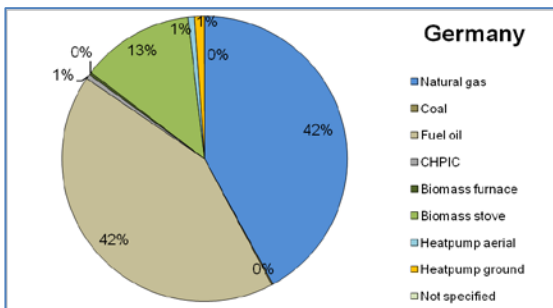
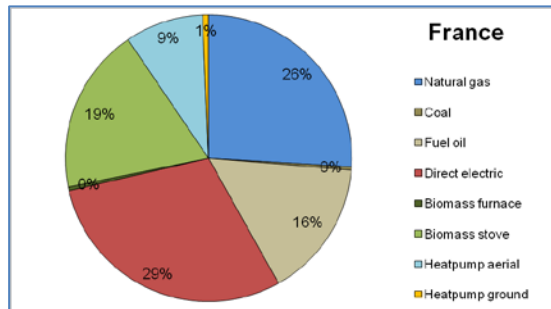
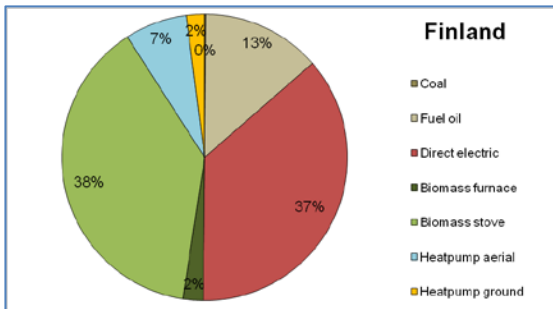
The shares presented in the following graphs are based on the installed capacities of decentral heating technologies in buildings. The shares are presented by country and at the end of the chapter for whole Europe. Additionally to the graph with installed capacities, for Europe also the shares based on the installed quantities are presented. The figures are based on the sources given in chapter 2. There are no graphs for Iceland, Lithuania, Norway and Switzerland as data was not available for several technologies and presenting the result in a similar graph as for the other European countries would lead to misinterpretations of the results in the respective countries.



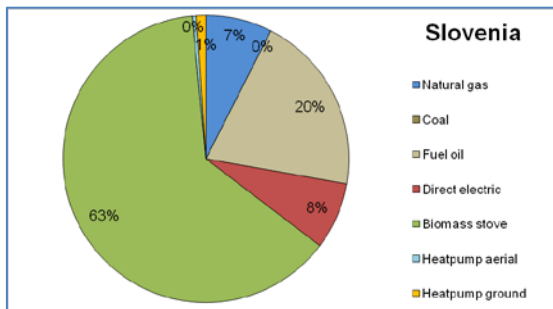
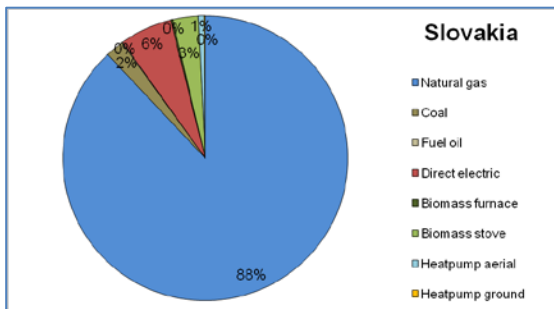
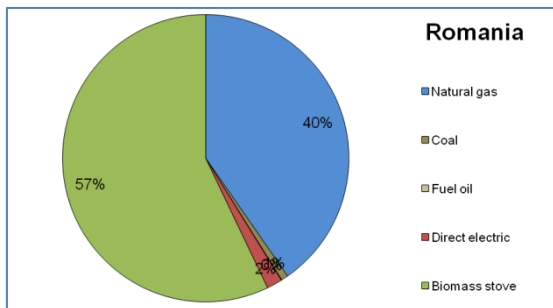
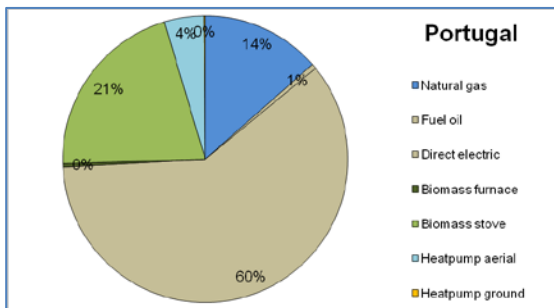
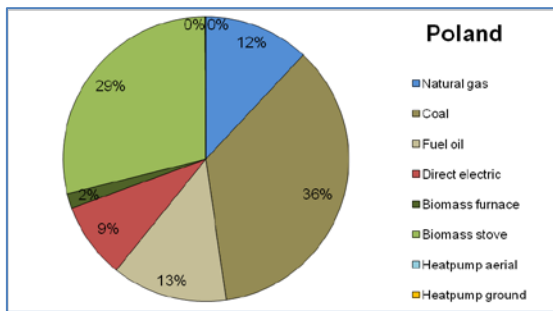
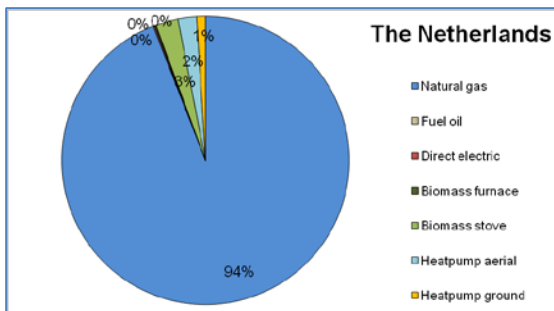
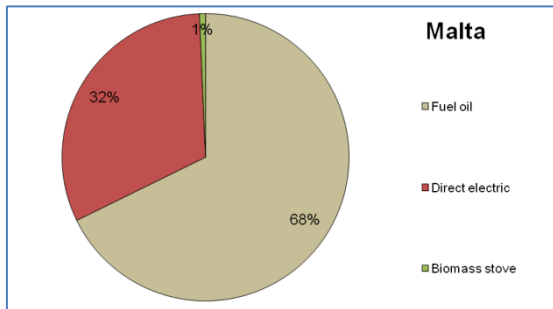
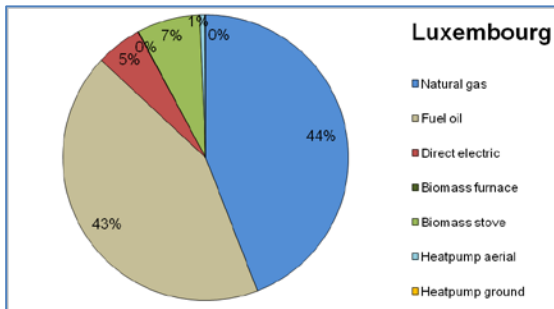
Work package 2: Assessment of the technologies



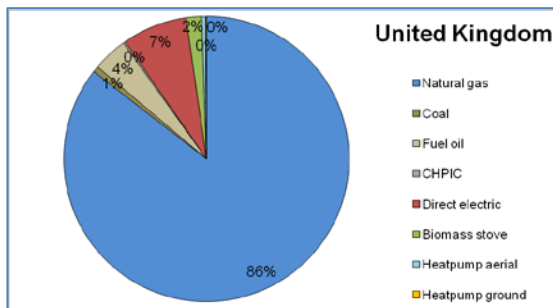
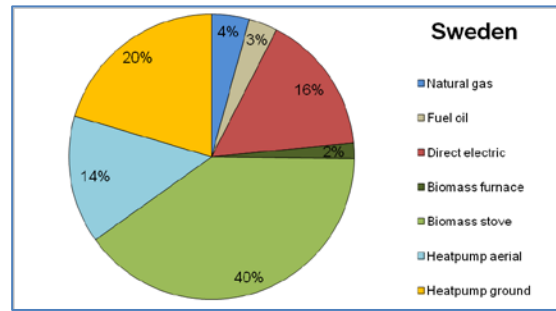
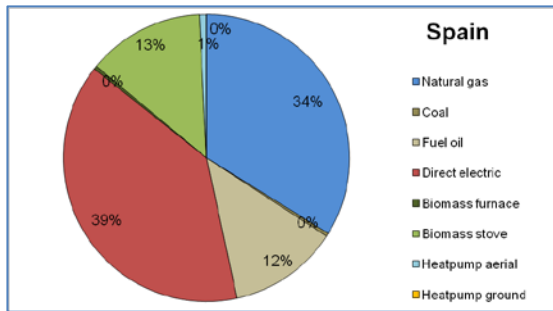
Work package 2: Assessment of the technologies



Work package 2: Assessment of the technologies

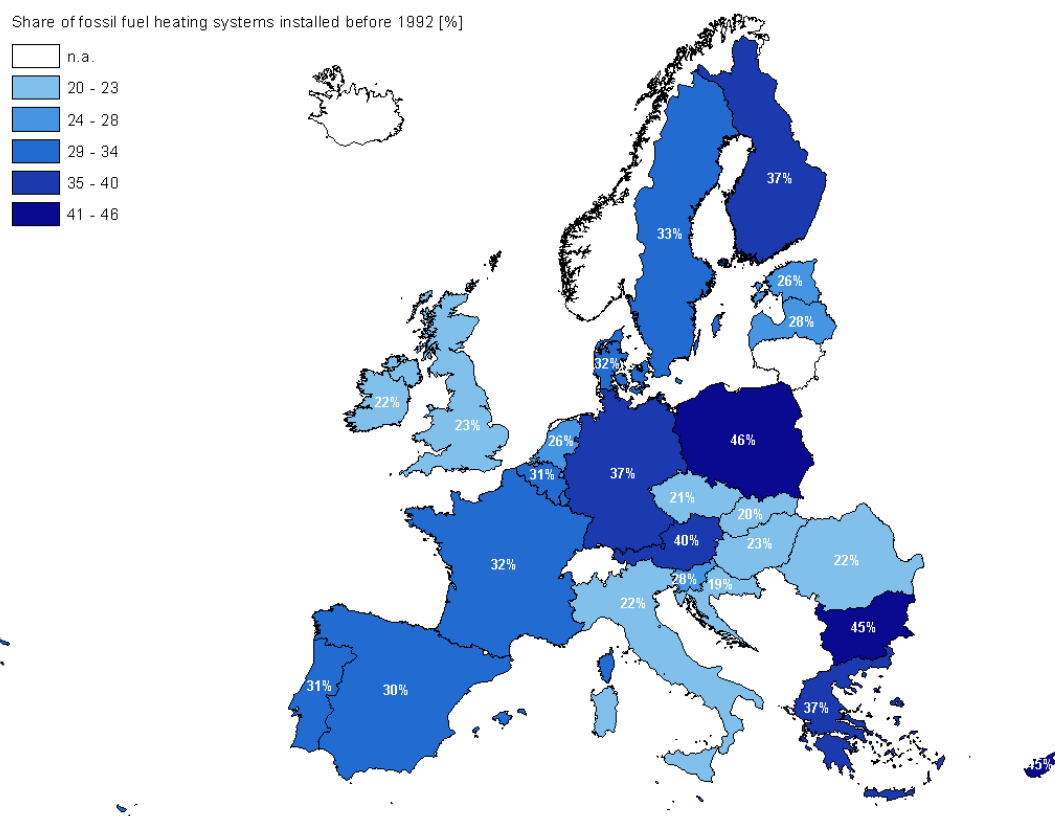


Work package 2: Assessment of the technologies



## 7.2 Proportion of individual fossil and renewable heating technologies in buildings installed before 1992 by country

The following maps illustrate the age of fossil and renewable heating technologies by country in the EU (except Lithuania as detailed data is not available for Lithuania). The figures are based on the sources given in chapter 2. Iceland, Norway and Switzerland are also not indicated as data was not available for several technologies and presenting the result in a similar graph as for the other European countries would lead to misinterpretations of the results in the respective countries.



## Work package 2: Assessment of the technologies

Share of RES heating systems installed before 1992 [%]

