



ANPA

**CEPN**

**GRS**

**IRSN**

**NRG**  
NEDERLANDSE  
REGULATIE  
ORGANISATIE  
VOOR  
KERNENERGIE

**nrpb**

## Final Report

# **Statistics on the Transport of Radioactive Materials and Statistical Analyses**

Customer's Contract No: 4.1020/D/01-003

**NRPB Chilton UK (Project co-ordinator)**  
**GRS Cologne Germany**  
**ANPA Rome Italy**  
**NRG Petten Netherlands**  
**IRSN Fontenay-aux-Roses, France**  
**CEPN Fontenay-aux-Roses France**

**March 2003**

**Project Team:**

**National Radiological Protection Board (NRPB), Chilton, Didcot, Oxon  
OX11 0RQ, UK**

K B Shaw  
J S Hughes  
S M Warner Jones  
S J Watson

**Gesellschaft fuer Anlagen- und Reaktorsicherheit (GRS) mbH,  
Schwertnergasse 1, 50667 Cologne, Germany**

H-J Fett  
F Lange  
G Schwarz

**Agenzia Nazionale per la Protezione Dell'Ambiente (ANPA), Via Vitaliano,  
Bracanti 48, 00144 Rome, Italy**

S Trivelloni  
L Matteocci  
P Caporali  
G Palmieri

**Nuclear Research and Consultancy Group (NRG), Westerduinweg 3,  
Petten, The Netherlands**

J van Hienen  
R Jansma  
F van Gemert

**Institut de Radioprotection et de Surete Nucleaire(IRSN), BP 17, F-92265  
Fontenay-aux-Roses, France**

G Sert  
J Brenot  
M T Lizot  
K Ben Ouaghrem

**IRSN sub-contractor:**

**Centre d'Etude sur l'Evaluation de la Protection dans le domaine  
Nucleaire (CEPN), BP 48, F-92263 Fontenay-aux-Roses, France**

T Schneider  
S Lepicard

## Contents

	Page
1. Introduction	4
2. Objectives and scope	5
3. Data collection	5
3.1 Contacts	6
3.2 Development of questionnaire	7
4. Responses and data	7
5. Analyses of data	20
5.1 Shipments	20
5.2 Exposures	23
6. Discussion and comment	27
7. Recommendations and conclusions	30
8. Acknowledgements	31
9. References	32
10. Glossary	33
Appendix 1. Letter to Competent Authorities	34
Appendix 2. Questionnaire	37
Appendix 3. Shipment and exposure data from Member States and Applicant Countries	43
Annex 1. Data from NRPB UK	73
Annex 2. Data from GRS Germany	89
Annex 3. Data from ANPA Italy	105
Annex 4. Data from NRG Netherlands	139
Annex 5. Data from IRSN France	179

# 1. INTRODUCTION

---

This final report presents the principal findings and conclusions of collaborative work funded by the European Commission (EC) to obtain information on the type and magnitude of radioactive material shipments in European Union (EU) Member States and Applicant Countries and the occupational and public radiation exposures arising from such shipments. The work has been performed under contract to the European Commission DG TREN (Contract No. C4/TMR2001/300-1) by organisations from five EU countries: NRPB UK (project co-ordinator), GRS Germany, IRSN (including subcontractor CEPN) France, ANPA Italy and NRG Netherlands. All of these organisations are highly experienced in work associated with radioactive material transport databases and the analyses of transport data.

Radioactive materials of natural or artificial origin are of widespread use across the world and are transported within and between countries. They cover a wide range of materials from small quantities of radiopharmaceuticals for medical use to highly radioactive spent nuclear fuel and vitrified waste arising from the nuclear fuel cycle. By its radioactive nature the handling, use, and management of radioactive materials (RAM) including its transport in the public domain gives rise to possible radiological (and in some cases non-radiological) hazards. Information on the transport of radioactive material is important to:

- demonstrate the efficacy of the international Transport Regulations [1],
- provide support for the continuous review and revision process of the international Transport Regulations,
- provide guidance and support to national, regional and international transport regulatory activities,
- support and guide compliance assurance,
- provide data for assessing and evaluating the doses and risks to workers and to members of the public,
- identify needs and trends in national and international transport activities, and
- provide factual information to assist in addressing public concerns on these issues.

## **2. OBJECTIVES AND SCOPE**

---

The main objectives of this study were to:

i) Collect and compile information on the type, volume and radiological characteristics of, and the doses arising from radioactive material shipments in the European Union (EU) and in the countries applying for accession to the EU.

ii) Perform statistical analyses of the transport of radioactive materials in EU Member States and the applicant countries where possible by:

- Type of package.
- Type of transport.
- Radiation exposures of workers and members of the public.
- Use of the radioactive material.

iii) Produce a full report.

The work involved data collection and analysis of both shipment data and exposure data. The latest available data were sought and compiled, primarily for the late 1990s, and trends identified where sufficient data were readily available.

The work programme of collecting, compiling and analysing radioactive material shipment data covered all types of radioactive materials and their uses. Shipment data on nuclear fuel cycle materials are generally available in most countries. Information on the movements of radionuclides for medical, scientific and industrial use is generally not as readily available but can be obtained from a variety of sources including data from major manufacturers and suppliers. In research and general industry there are varied uses of radioactive materials. In some cases the same radioactive source in its package may be regularly transported from its base, for example in the case of industrial radiography. Where possible, shipment data of consumer products and low specific activity materials containing small quantities of radionuclides are included in the transport survey.

## **3. DATA COLLECTION**

---

The five organisations that performed this work are from EU Member States that have substantial transport operations concerned with the use of radioactive materials in medicine, research, general industry and the nuclear fuel cycle. These Member States also have different structures of licensing and surveillance, and transport data on normal operations are collected in different formats.

The scope, level of detail and frequency of collection and analysis of statistical transport and exposure data varies widely depending on the type of radioactive material and mode of transport and the nationally existing institutional and regulatory requirements.

Generally, shipments of fissile material and large-quantity radiation sources by all modes have been more intensively controlled by the national Competent Authorities than have other categories of radioactive materials. Hence, in most countries the level of information is greater for the transport of fissile material and large-quantity radiation sources by virtue of an authorisation system generally adopted for such shipments.

Data on the shipments of other radioactive materials are not always easily available in the various countries for different reasons: for example the absence of binding provisions to collect data or difficulties in collecting and processing of the data due to a lack of resources or the confidentiality of the data. Some countries that have a binding system of notification or authorisation of radioactive material shipments are facilitated in collecting data by the operators and have organised a system to manage those data. Other countries that do not have such systems collect data generally through consignors or carriers that provide those data on a voluntary basis.

Occupational and public exposure data are generally not being collected, reported and published by transport operators and Competent Authorities on a routine basis. Therefore other collection and analysis methods have been employed for the purposes of this study.

Collection and compilation of radioactive material transport data in Applicant Countries and EU Member States other than those involved in the project were based on a questionnaire survey. The relevant questionnaire forms covering transport and exposure data were developed within the project.

There are some published data on the radiation exposures of workers and members of the public from normal transport operations but in some countries such data are not published. These available data have been reviewed and work performed to develop a consistent body of information for analysis, evaluation and documentation. To some extent advantage was taken of compilations of transport and exposure data collated within other assessment studies including other EC-funded research projects [2,3,4,5].

### **3.1 Contacts**

A list of appropriate contacts in EU Member States and Applicant Countries was developed from information provided by the European Commission and the contractors. A preliminary letter (see Appendix 1) was sent to these contacts to establish a line of communication and to inform them of the project.

### 3.2 Development of questionnaire

In order to facilitate responses, from Member States and Applicant Countries, a short questionnaire together with a guidance note was developed: this is given in Appendix 2.

## 4. RESPONSES AND DATA

---

The contractors provided detailed information from their own countries on shipments of radioactive materials and the resulting radiation exposures. Annexes 1 to 5 contain the detailed reports from each contractor. A brief summary of these data follows:

#### i) UK

Shipment and exposure data are from published studies mainly in the 1990s of shipments and exposures from the transport of radioactive materials by various modes as well as information from the various areas of the industry on movements in 2001. Full data are given in Annex 1.

Exposure data 1989 - 2001 have been obtained from the UK Central Index of Dose Information [6] for transport workers who are classified radiation workers. These data are given in Table 1 below. The total number of transport workers in these areas has probably not changed significantly but the number categorised as classified workers has decreased substantially.

Shipment data have been collected for 2001/2002. The data for the nuclear fuel cycle are actual shipment and package numbers. The other data are best estimates. Radioisotope data are based on actual shipment data over a 4 month period extrapolated to 12 months. Information was generally not readily available on Type B packages for medical and general industrial use other than imports of  $^{99}\text{Mo}$  for the production of technetium generators. Molybdenum is imported to the UK main producer of radioisotopes three times per week from Africa. Radiation source data were provided by many of the users and extrapolated to cover the whole UK. Nuclear density gauge shipment data were obtained from the industry. It is estimated that there are some 100 portable nuclear density gauges in operation with the operators carrying out about 6000 return journeys. Information on site decommissioning, gemstones, laundry wastes and consumer products was provided by the industry but are not necessarily final totals.

Table 1: UK classified transport worker exposures

Year	Dose Range, mSv									Total No. Workers	Collective Dose man Sv	Mean Dose mSv
	0	0.1-1	1.1-5	5.1-10	10.1-15	15.1-20	20.1-30	30.1-50	50.1+			
1989	68	224	67	42	7	2	0	0	0	410	643	1.6
1990	47	206	91	38	3	0	0	0	0	385	613	1.6
1991	72	170	65	7	0	0	0	0	0	314	261	0.8
1992	65	173	16	4	2	0	0	0	0	260	160	0.6
1993	61	122	34	6	0	1	1	0	0	225	190	0.8
1994	49	89	23	3	2	0	2	0	0	168	171	1
1995	53	68	15	11	7	0	0	0	0	154	211	1.4
1996	46	80	10	8	2	0	0	0	0	146	134	0.9
1997	24	80	19	8	1	0	0	0	0	132	151	1.1
1998	37	79	15	8	0	0	0	0	0	139	130	0.9
1999	27	26	27	3	1	0	0	0	0	84	107	1.3
2000	34	37	23	2	0	0	0	0	0	96	78	0.8
2001	27	31	20	0	0	0	0	0	0	78	53	0.7



Table 2: Shipment data from the UK (2001).

Radioactive Material	Annual transport volume		Predominant transport mode			
	N° Shipments per Year	N° Packages per Year	Road	Rail	Air	Sea
<b>Fuel Cycle Material*:</b>						
Irradiated fuel assemblies, fuel pins (UO <sub>2</sub> , MOX)	na	863	x	x		
Non-Irradiated fuel assemblies, fuel pins (UO <sub>2</sub> , MOX)	170	750	x	x		
Uranium/thorium ore	370	13,300	x	x		
Pre-fuel material (UOC, U <sub>3</sub> O <sub>8</sub> , UO <sub>2</sub> , MOX, pellets etc.)	36	970	x	x		x
Uranium Hexafluoride (UF <sub>6</sub> )	662	2144	x	x		x
Low-/intermediate-level radioactive waste (LLW/ILW)	na	na	x			
Unloaded (empty) flasks	na	936	x	x		
<b>Radioisotope Supply and Distribution:</b>						
Type B packages	na	na	x		x	x
Type A packages	na	132,000	x		x	x
Excepted packages	na	66,000	x		x	x
Others						
<b>Radiation Sources:</b>						
Radiographic radiation sources	1,000	1,000	x			
Nuclear density/portable gauging devices	12,000	12,000 <sup>1</sup>	x			
Others						
<b>Non-nuclear Radioactive Wastes</b>						
Site Decommissioning	28	28				
<b>Consumer Products</b>						
Smoke detectors	200	1,050	x			x
Gem Stones	42	177			x	
Laundry/Various analytical	155	155	x			

\*Nuclear fuel cycle data are actual volumes. Other data are best estimates. na is data not currently available.

1. There are about 100 operators involved.

## ii) Germany

Radioactive material transport data are based on a nationwide survey completed in the 1990s. Data cover all modes of transport and all major areas of application: that is nuclear fuel cycle, radiation sources and radioisotopes. Exposure data have been collected and analysed, based on recent surveys, and are mainly from personal monitoring data. Full data are given in Annex 2.

The level of information acquired in the radioactive material transport survey permitted general categorisation of the radioactive material shipment by field of application and the results are given in Table 3. The radioactive material transport survey results are most representative for the early 1990s and for West Germany (former GDR excluded).

The survey results indicate that non-nuclear radioactive material shipments for applications in various disciplines of medicine, research and industry represent the largest fraction of the radioactive material transported in Germany with an annual volume of about 443 000 shipments per year. The materials shipped are typically radiopharmaceuticals, labelled compounds in gaseous, liquid or solid form for scientific purposes, and monitoring, testing and gauging devices for numerous industrial applications. Also included are substances such as natural and depleted uranium and non-nuclear radioactive waste. A significant fraction of these radioactive material shipments contain relatively small quantities of radioactivity in the range of a few Kilo-Becquerel to a few Giga-Becquerel for medical, scientific and industrial use in packagings that are within the Excepted package criteria of the Transport Regulations. The preferred mode of transport for this category of material is by road and air. Approximately 99 percent of the total traffic relates to the category of non-nuclear radioactive materials with a cumulative travel distance of about 43 million kilometres. The nuclear fuel cycle shipments represent only a minor fraction of the total national radioactive material movements.

The mode-specific transport survey results in terms of the number of radioactive material shipments and packages, the total radioactivity shipped and travel distances of radioactive materials moved in Germany (former GDR excluded) are shown in Table 4. The total annual number of radioactive material shipments is approximately 445,000 per year for all modes of transport, i.e. road, rail, air and sea. A major fraction of these radioactive material shipments are transboundary shipments. Road transport represents the most dominant shipping mode with an annual volume of about 410,000 shipments and 665,000 shipped packages. Transportation by air ranks second with approximately 19,000 shipments annually and a total of 240,000 shipped packages, that is most shipments are multiple package shipments. The annual radioactive material shipments by rail total about 15,500 with 17,000 packages. The data on radioactive material shipments by sea are of a preliminary nature but the annual transport volume has been estimated to be of the order of about 500 shipments and 2,000 packages.

Table 3: Transport of radioactive material in Germany by field of application

Type of material and field of application	Shipments (per year)	Packages (per year)	Cumulative Activity (TBq)	Distance Travelled <sup>a)</sup> (Mill. km)
<u>Fissile material:</u>				
Nuclear fuel cycle, research and development <sup>b)</sup>	1,900	9,500	24 x 10 <sup>6</sup>	0.4
<u>Non-fissile radioactive material:</u>				
- Nuclear fuel cycle	6,630	26,000	ca. 500	1.2
- Radiographic and other radiation sources	65,000	75,000	--	6
- Medicine, research, industry	370,000	815,000	ca. 70,000	35
Total (rounded)	445,000	---	24 x 10 <sup>6</sup> b)	44
a) Travel distance by road and rail b) Total activity for all modes of transport				

Table 4: Transport of radioactive material in Germany by mode of transport

Transport Mode	Shipments (per year)	Packages (per year)	Cumulative Activity (TBq)	Distance travelled <sup>1)</sup> (Mill. km)
Road	410,000	665,000	7 x 10 <sup>6</sup>	40
Rail	15,500	17,000	22 x 10 <sup>6</sup>	< 4
Air	19,000	240,000	<< <sup>2)</sup>	---
Sea	500 <sup>4)</sup>	2,000 <sup>4)</sup>	--- <sup>3)</sup>	---
Total	ca. 445,000	---	---	44
1) Travel distance within Germany 2) "<<" = Value very small 3) "---" = Value currently not available 4) Best estimate based on limited data				

Table 5 summarises the survey and assessment results in terms of typical maximum occupational and public radiation exposures resulting from the normal (incident-free) transport and handling of radioactive material package shipments in various fields of applications of radioactive substances. The survey and assessment results indicate that the occupational and public exposures arising from normal (incident-free) transport operations of radioactive material shipments are generally in the order of, or well below, 1 mSv y<sup>-1</sup> for transport workers (e.g. drivers, package handlers etc.) and 0.1 mSv y<sup>-1</sup> for members of the public in all major fields of radioactive material transport. Radiation exposures in this dose range represent only a small fraction of the relevant regulatory dose limit for radiation workers and the public of 20 mSv y<sup>-1</sup> and 1 mSv y<sup>-1</sup>,

respectively. Occupational radiation doses received by airport personnel (package handlers) and lorry drivers involved in front & back end fuel cycle material shipments are indicative that low occupational doses have prevailed in these transport operations for many years in Germany.

Table 5: Maximum radiation doses received by workers and members of the public from the normal (incident-free) transport of radioactive material for various transport operations in Germany.

Transport Operations/Field of Application	Transport Mode	Maximum Effective Dose (mSv y <sup>-1</sup> )	
		Workers	Public <sup>a)</sup>
Non-irradiated nuclear fuel cycle material, e.g. U <sub>3</sub> O <sub>8</sub> , UF <sub>6</sub> , UO <sub>2</sub> -powder/pellets, non-irradiated fuel assemblies, radiation sources	Road/Rail	< 1	--- <sup>b)</sup>
	Sea	< 1 <sup>c)</sup>	---
Irradiated nuclear fuel cycle material, e.g. activated/contaminated equipment and components, radioactive waste, irradiated nuclear fuel, vitrified waste, radiation sources	Road	1 - 2	< 0.05
	Rail	< 1	< 0.1
Non-nuclear radioactive waste, e.g. medical and research waste	Road	< 1	---
Transport and distribution of radioisotopes for research, medicine and industry, other radioactive materials	Road	10 - 14	< 0.04
	Air	< 1	---
Radiographic and other radiation sources	Road	< 1 <sup>d)</sup>	---
<i>Regulatory Dose Limits</i>		20	1
a) Relevant to the hypothetical individuals, e.g. permanent residents/by-standers or users of the transport route. b) "---" = Data currently unavailable. c) Preliminary value derived from the general literature. d) Transport-related worker dose without the extra dose received from the field use of radiographic radiation sources.			

This situation holds basically also for the transport by road and transport-related operations associated with the supply and distribution of medical, scientific and industrial radioisotopes where 80 - 85 percent of transport worker doses are found to be below 1 mSv y<sup>-1</sup>. Under certain conditions, however, where routinely large volumes of packaged (generally Excepted and Type A packages) radioisotopes for applications in medicine, research and industry are shipped and handled, for example, at warehouses and redistribution centres, maximum occupational annual transport worker (drivers/handlers) doses can be as high as 10 - 14 mSv per year. The number of drivers/handlers being exposed to these increased levels is, however, generally limited. The latter observation is a general feature of transport worker dose distributions available from a number of other EU Member States for transport operations of a comparable nature [3].

Similarly, site radiographers involved in the transport of radiographic radiation sources for non-destructive testing (NDT) typically receive exposures from both the transport (by road) and field use of such radiation sources. While the transport-related worker doses are typically below 1 mSv per year the additional radiation dose resulting from the field use of the radiation source can be quite significant.

iii) Italy

Comprehensive radioactive material shipment data for road transport have been provided for the years 1996-2000 and are given in Annex 3: the data are extracted from the national database [7]. Worker exposure data have also been collected and reported. Data for 2000 are given in the tables below.

Table 6: Number of radioactive material shipments and packages by road in Italy (2000)

Type of package	Number of shipments	Number of packages	Number of shipments %	Number of packages %
Type B	2,445	440	2.8	0.2
Type A	3,1431	109,037	36.6	56.4
Industrial package	278	1094	0.3	0.6
Excepted package	51,651	82,804	60.2	42.8

The data show that Type A packages (56.4%) and Excepted packages (42.8%) are most frequently transported. Type B packages represent only 0.2% and are related in large part to the transport of radiographic devices for non destructive testing. Shipment data for all modes of transport are given in Table 7.

Table 7: Package type and transport mode data in Italy (2000)

Package Mode of transport	Type B	Type A	Industrial package (IP-1, IP-2, IP-3)	Excepted Package	Total
Road	440	109,037	1,094	82,804	193,000
Rail	0	0	0	0	0
Air	42	28,378	21	11,332	40,000
Sea	18	104	1	0	123

Road transport is the most frequently used mode of transport in Italy. Air transport is the second in terms of packages shipped (21%) while only a small percentage of packages are transported by sea. There are no transports by rail. Estimates have been made of occupational and public exposure from the transport of radioactive materials. These data are listed in Tables 8 and 9.

Table 8: Annual effective dose for Italian transport workers (2000)

No. Workers	Annual collective dose man mSv y <sup>-1</sup>	Average dose mSv y <sup>-1</sup>	Dose min – max mSv y <sup>-1</sup>	Total TI	Collective radiation doses per unit TI man mSv y <sup>-1</sup>
456	461	1.01	0.01 – 5.4	83,011	0.005

Table 9: Population exposure in Italy from the transport of Type A packages for primarily medical use

No. Shipments	No. packages	TI per package	TI load on vehicle	Total TI	Total distance travelled km	Individual Dose μSv y <sup>-1</sup>	Collective dose man mSv y <sup>-1</sup>
244	3,420	0.2	2.8	789	12,450	1.2	219

iv) France

In 1997, French carriers and consignors have declared 345,000 packages transported through 31,000 transports. The number of transports of gammagraphs, gamma density gauges and lead analysers were underestimated and the total number of packages transported could be 700,000 according to the french estimation taking into account a 2002 questionnaire sent to the main users of gammagraphs. The work performed has highlighted that a significant number of users of packages for civil industries had been forgotten in the analysis performed in 1997. In addition due to a new regulation concerning the trade of ancient lodgings (ministerial order dated 12<sup>th</sup> of July 1999 requiring mandatory check of presence of lead in wall paintings) a new category of transport now exists which corresponds to an annual total of approximately 260,000 transports.

Data have been analysed by type of package, mode of transport and type of material. Exposure data have also been assessed: the data are currently provided in terms of collective dose and individual doses. Complete data for France are presented in Annex 5.

Table 10 presents the number of transports and the number of packages per transport mode. Each transport mode was well represented in the survey (only 0.01% unspecified): 91.4% of packages were transported by road, which is the most frequent transport mode; 8.5% of packages were transported by rail; 7.6% of packages were transported by air, and 2.3% of packages were transported by sea.

Table 10 : Number of transports and transported packages per transport mode

Mode of transport & combination	Number of transports (rounded)	Number of packages (rounded)	Number of transports %	Number of Packages %
Road only	405,000	60,000	98.99	83.6
Rail only	910	46,000	0.22	6.41
Sea	21	800	0.01	0.11
Air + Road	2,700	55,000	0.66	7.60
Rail + Sea	220	15,000	0.05	2.04
Rail + Road	130	380	0.03	0.05
Sea + Road	130	1,200	0.03	0.17
Unspecified	1	100	0.00	0.01
Total	410,000	720,000	100	100
Sub total Road	410,000	66,000	99.7	91.4
Rail	1,200	61,000	0.3	8.5
Air	2,700	55,000	0.6	7.6
Sea	370	17,000	0.1	2.3

For the packages transported, 30% were Type A packages, 14% were Industrial Packages, 46% were Excepted packages, and 7% were Type B packages. In 0.4% of cases, the package type was not specified.

The most frequent package transports are, in decreasing order, Excepted packages by road (44%), Type A packages transported by road (26%), Type B packages by road (7%), Type A packages by air (6%), Industrial

packages by rail (6%), Industrial packages by road (6%), Excepted packages by air (2%), and Industrial packages by sea (2%).

The data from France are the best currently available but need to be confirmed in the future by an additional survey of the transport flows for civil industry.

The annual worker doses from radiopharmaceutical, nuclear fuel cycle and civil industry transports are presented in table 11.

Table 11: Annual worker doses

Company	Type of use	Year	Number of monitored workers	Film location	Maximal dose mSv y <sup>-1</sup>	Average dose mSv y <sup>-1</sup>
SITA	Radiopharmaceutics	1997	13	Thorax	7.1	3.87
			12	Wrist	4	2.25
		2000	11	Thorax	16.2	8.09
			10	Wrist	16.4	11.3
TRANSROUTE SANTE	Radiopharmaceutics	1997	67	Thorax	37.5	11.41
		2000	9 (et 13 sous traitants)	Thorax	17.05	4.89
FedEx (airport)	Radiopharmaceutics	2002			14*	
SNCF	Nuclear fuel cycle and civil industry	1997	127	Thorax	0	0
COGEMA Valognes	Nuclear fuel cycle	1997		Thorax	4	
		2000		Thorax	4	
Le maréchal	Nuclear fuel cycle	1997	47	Thorax	0.4	0.26
Celestin	Nuclear fuel cycle	1997	35	Thorax	1.05	0.43
		2000	23	Thorax	0.4	0.33
Deret	Nuclear fuel cycle	1997	11	Thorax	2	1.3
		2000	11	Thorax	0	0
COGEMA Logistics	Nuclear fuel cycle	1997	27	Thorax	0.3	0.25
		2000	68	Thorax	0.25	0.25
Baudry	Nuclear fuel cycle	2000	3	Thorax	1.9	1.9
Agrestest Porcieu	Civil industry	2000			3.2**	
PLS contrôle	Civil industry	2000			16.2**	
Institut de soudure	Civil industry	2000			16.4**	

\*from calculations

\*\* from questionnaires sent to companies

Estimates have been made of collective doses to the public associated with the transport of radioactive materials in France for the year 1997. It has been performed on the basis of previous studies and complementary data provided by IRSN.

Collective doses related to the transport of medical sources represent the highest contribution (>52%) to the total public exposure, ranging from 1.3 to 3.168 man.Sv over a total of 2.515-5.195 man.Sv. Public exposures associated with transport for the nuclear fuel cycle are far lower, that is a few hundreds of man.mSv y<sup>-1</sup>. These results can be put into perspective with the total public collective dose associated with the whole nuclear fuel cycle in France, which is estimated to be about 5,000 man.Sv collective dose, for an annual nuclear electricity generation of 376 TWh.

The maximum individual doses associated with hypothetical scenarios for the different types of transports considered are estimated to be about 70-200  $\mu\text{Sv y}^{-1}$ . They correspond to the movements of spent fuel, radioactive wastes converging to the storage centre of Aube (CSA) and to the temporary storage of medical sources from SCHERING CIS-BIO at TransRoute Santé. It must be noted that these results are based on approximate assumptions concerned with routine conditions of transport, and should be confirmed by an in-depth evaluation of individual exposures of more realistic critical groups.

Table 12: Summary of individual doses for public – Hypothetical scenarios of exposure associated with the transport of radioactive materials in France

Related industry	Scenario	Individual dose
Nuclear fuel cycle	Scenario 1: spent fuel; exposure along railways	1.1 $\mu\text{Sv y}^{-1}$ (200 shipments)
	Scenario 2: vitrified wastes; exposure along railways	0.05-0.08 $\mu\text{Sv y}^{-1}$ (10 shipments)
	Scenario 3: Uranium oxide LR 65 containers; exposure along railways	0.4 $\mu\text{Sv y}^{-1}$ (239 shipments)
	Scenario 4: spent fuel; train stops near buildings	30-200 $\mu\text{Sv y}^{-1}$ (200 shipments)
	Scenario 5: spent fuel; train stops under bridge	5 $\mu\text{Sv}$ (single shipment)
	Scenario 6: spent fuel; truck stops at road light	6 $\mu\text{Sv y}^{-1}$ (200 shipments)
	Scenario 7: vitrified wastes; truck stops at road light	0.3-0.5 $\mu\text{Sv y}^{-1}$ (10 shipments)
	Scenario 8: Uranium oxide LR 65 containers; truck stops at road light	2.3 $\mu\text{Sv y}^{-1}$ (239 shipments)
	Scenario 9: fuel assemblies, truck stops at road light	4 $\mu\text{Sv y}^{-1}$ (196 shipments)
	Scenario 10: UF <sub>6</sub> , truck stops at road light	2 $\mu\text{Sv y}^{-1}$ (95 shipments with empty packages and 70 shipments with full packages)
Medical sources	Scenario 11: SCHERING CIS-BIO transports through "Christ de Saclay"	0.84 $\mu\text{Sv y}^{-1}$ (4,160 Type-A vehicles) 0.002 $\mu\text{Sv y}^{-1}$ (200 Type-B vehicles)
	Scenario 12: Storage at TransRoute Santé	120 $\mu\text{Sv y}^{-1}$ (SCHERING CIS-BIO Type-A packages)
Radioactive wastes (nuclear fuel cycle and civil research and industry)	Scenario 13: truck stops at road traffic lights	13-67 $\mu\text{Sv y}^{-1}$ (1 355 shipments delivered to CSA)



#### v) Netherlands

Shipment data have been provided for 2001 on spent nuclear fuel, radioactive wastes, UF<sub>6</sub> and radiopharmaceuticals. Worker exposure data have been obtained from consignors and data on exposures of the public have been obtained from assessments for these shipments. Shipments of sources (NDT) are not included in the shipment data.

Shipment data on nuclear fuel and fuel cycle materials have been obtained from license information and contacts with nuclear power plants. For shipments of non-fuel cycle material detailed reporting is not compulsory. Therefore full co-operation of the consignors is required to obtain detailed data.

In the past (1992) limited surveys of radioactive material shipments have been made. The results from more recent surveys in 1997 and 1998 have been published as part of international studies for the European Commission [2,3].

For the present survey, data have been obtained from the nuclear power plant operators, the central organisation for radioactive waste management and two main distributors of radiopharmaceuticals. In addition, shipment data on UF<sub>6</sub> and NDT sources for previous years have been used. Full data are provided in Annex 4.

A summary of the obtained data is presented in Table 13. The results show that more than 95% of the annual RAM shipments in the Netherlands contain radiopharmaceuticals. More than 50% of these shipments are for export. Two categories of these shipments may be identified: firstly, bulk shipments by road with an average of 120 Type A packages, which are transported to distribution centres in neighbouring countries. Secondly, individual shipments with an average of 3 Type A packages or Excepted packages (5% of the cases), which are transported to the consignee. Included in the 13,300 shipments are the 2,300 shipments with about 55,000 packages to be shipped to airports for further transport.

The number of packages with radiopharmaceuticals has slightly increased since the 1998 survey, by about 9%. Handlers involved in the preparation/vehicle loading of the shipments of these packages receive the highest annual doses of transport workers. The maximum value of the annual individual dose of these handlers is approximately 10 mSv. Despite the increase of the number of packages, the collective doses of these handlers have decreased during the last few years due to operational and technical measures. The average collective dose per TI handled has been reduced from 1 man  $\mu$ Sv/TI (1998) to 0.5 man  $\mu$ Sv/TI (2001). Also the average collective dose per TI for drivers has been reduced from 0.8 man  $\mu$ Sv/TI (1998) to 0.6 man  $\mu$ Sv/TI (2001).

Dose reductions have also been observed for the group of workers involved in the preparation of shipments of irradiated fuel, although presently the monitoring and cleaning operations are more extensive

than before 1997, the year in which these shipments were temporarily banned. For one consignor the average dose per shipment has been decreased from 2.1 man mSv (before 1997) to 0.75 (in 2002). The estimated annual individual dose in 2001, due only to preparation of shipments, is about 2 mSv.

The maximum value of the annual individual dose of workers involved in the collection of waste packages is approximately 1 mSv. This value has not changed much during the last few years although the number of waste packages has been increased.

Doses of the most exposed members of the public, the so-called critical groups of the population, have been assessed from model-calculations based on actual situations and relevant traffic statistics. Theoretically, the highest expected individual dose for these critical groups is about 20  $\mu$ Sv per year. This value is relevant for the hypothetical group of residents living near the freight station where nuclear fuel flasks are transferred from lorry to train wagon (15  $\mu$ Sv  $y^{-1}$ ) and for the hypothetical group of drivers which use the same route and driving at the same time as shipments of radiopharmaceuticals (10 – 20  $\mu$ Sv  $y^{-1}$ ). However, taking into account the actual situations during exposure, annual public doses of less than 2  $\mu$ Sv  $y^{-1}$  have been calculated for the critical group exposed to these shipments.

Table 13: Transport of Radioactive Material in the Netherlands (2001)

Type of material and field of application	Shipments (per year)	Packages (per year)	Collective worker dose (man mSv)	Est. individual public dose ( $\mu$ Sv)
<u>Nuclear fuel cycle:</u>				
- Spent nuclear fuel	12 <sup>a)</sup>	22 <sup>a)</sup>	22	0.03-19
- Waste	65	876	ca. 1	0,1
- UF <sub>6</sub>	280	880	-	-
<u>Non-fuel cycle:</u>				
- Radiopharmaceuticals	13300	286000	130	0-20
- waste	93	3000	ca. 1	0.1
- Radiographic sources	60	60	-	-
Total (rounded)	13800	291000	-	-
<sup>a)</sup> There are two additional shipments in 2001 with 3 packages each, for which no exposure data are available.				

vi) Other EU Member States and Applicant Countries

In addition to the data from contractor's countries, responses to the questionnaire were received from 9 other EU Member States and 11 Applicant Countries. These EU Member States and Applicant Countries are listed in Table 14. Responses were not received from Portugal, Bulgaria and Slovenia.

Table 14: EU Member States and Applicant Countries that provided responses to the questionnaire.

Reporting organisation	Country
Bundesministerium für Verkehr, Innovation und Technologie	Austria
Federal Agency of Nuclear Control	Belgium
National Institute of Radiation Hygiene	Denmark
Radiation and Nuclear Safety Authority (STUK)	Finland
Greek Atomic Energy Commission	Greece
Radiological Protection Institute of Ireland	Ireland
Direction de la Santé, Division de la Radioprotection	Luxembourg
Consejo de Seguridad Nuclear	Spain
Swedish Radiation Protection Institute	Sweden
Swedish Nuclear Power Inspectorate (SKI)	Sweden
Cyprus Airways	Cyprus
State Office for Nuclear Safety	Czech Republic
Estonian Radiological Protection Centre	Estonia
Hungarian Atomic Energy Authority	Hungary
"Frédéric Joliot-Curie" National Research Institute for Radiobiology and Radiohygiene	Hungary
Radiation Safety Centre	Latvia
Ministry of Environment of the Republic of Lithuania	Lithuania
Ad. Hoc. Committee on Protection from Radiation Occupational Health and Safety Authority,	Malta
Malta Maritime Authority	Malta
National Atomic Energy Agency	Poland
National Commission for Nuclear Activities Control	Romania
The Ministry of Transport, Post and Telecommunication	Slovak Republic
Nuclear Regulatory Authority of the Slovak Republic (ÚJD)	Slovak Republic
Radiological Health & Safety Department, Turkish Atomic Energy Authority	Turkey

Shipment data for nuclear fuel cycle operations are generally available but data on movements of radioactive materials for medical use and general industrial use are not generally as comprehensive. Only a few countries have shipment databases recording all shipments on a regular basis. Appendix 3 lists the shipment data and exposure data provided in responses to the questionnaire.

## 5. ANALYSES OF TRANSPORT DATA

---

### 5.1 Shipments

The most comprehensive shipment data is that of package type. In most countries Excepted and Type A packages are the most frequently transported packages. Figure 1 shows the distribution of the total number of packages in all responding countries by package type. Shipment data are not complete since not all countries provided data on all package types.

Figure 1. Distribution of packages by type

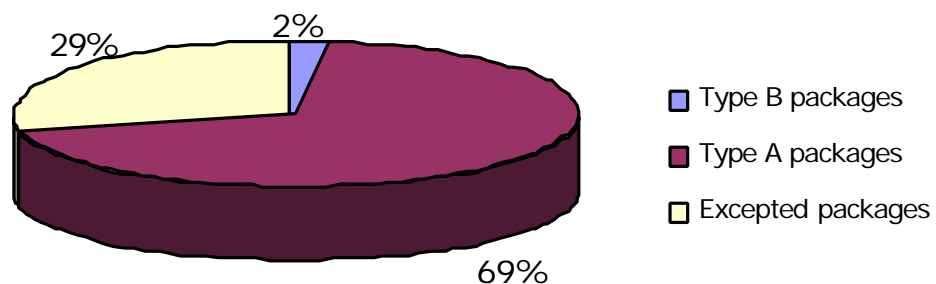

The data on package numbers is generally well known for nuclear fuel cycle operations but in most cases is estimated for other transport operations. The data presented in Figure 2 are taken from the information supplied by countries for this survey. There are many reasons for the differences in package numbers between countries. Some countries have a large in-transit component, some have nuclear fuel cycle operations and some have major suppliers of radionuclides.

**Figure 2. Radioactive material transport in EU Member States and Applicant Countries (1990s/early 2000)**

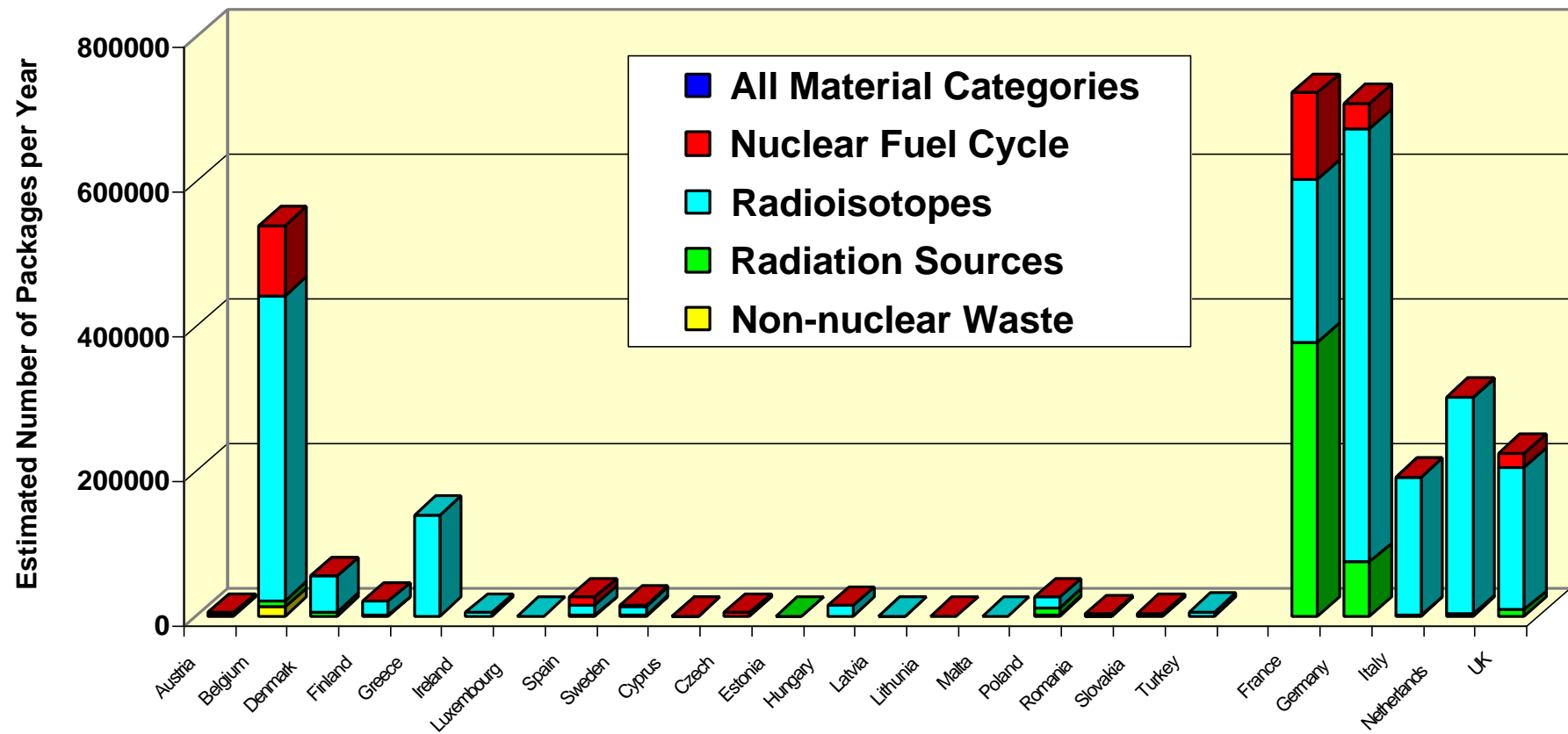

Most countries do not have sufficient shipment data to establish trends for all categories of radioactive material. However Italy has such data for a major fraction of the national traffic of radioactive material shipments over a 14 year period. The analyses of shipment data from Italy are for shipments carried out during the period 1987 - 2000 by authorized carriers. The results of the analysis of data are based both on direct analyses and also by sampling data. Trend analyses have been carried out to evaluate changes in the use of radioactive materials and to evaluate transport flows. The data regarding the number of shipments and number of packages transported during the period analysed are summarized in Table 15.

Table 15: Radioactive material transport data in Italy (1987-2000 )

Year	No. Packages	No. Shipments
1987	227,000	61,000
1988	336,000	81,000
1989	341,000	78,000
1990	345,000	92,000
1991	334,000	83,000
1992	465,000	90,000
1993	469,000	148,000
1994	449,000	144,000
1995	406,000	134,000
1996	458,000	155,000
1997	356,000	134,000
1998	287,000	118,000
1999	203,000	99,000
2000	193,000	86,000

Data on spent fuel shipments from civil reactors and discharged flask shipments from the reprocessing site in the UK from 1997 to September 2002 are presented in Tables 16 and 17.

Table 16: Discharged Fuel Flask Shipments from and to UK Nuclear Power stations

Calendar Year	1997	1998	1999	2000	2001	2002 <sup>2</sup>	Total
Sellafield to BNFL	395	332	376	402	471	375	2351
Sellafield to BE	361	333	385	359	398	236	2072
Total	756	665	761	761	869	611	

Table 17: Loaded Fuel Flask Shipments from and to UK Nuclear Power stations

Calendar Year	1997	1998	1999	2000	2001	2002 <sup>2</sup>	Total
BNFL to Sellafield	390	341	370	400	465	368	2334
BE to Sellafield	361	333	385	359	398	236	2072
Total	751	674	755	759	863	631	

In Germany consistent long-term shipment data are only available for specific categories of radioactive materials, e.g. spent nuclear fuel. Figure 3 gives an overview over the number of commercial reactor spent nuclear fuel shipments for the time period from 1971 - 2001. It is evident

<sup>2</sup> Shipments up to 30/09/2002

from Figure 3 that the annual volume of commercial reactor spent nuclear fuel shipments has been consistently in the range of about 60 - 100 shipments annually over the last two decades following an initial phase of fewer shipments in the seventies.

Figure 3: Commercial reactor spent fuel shipments in Germany (1970 - 2001)

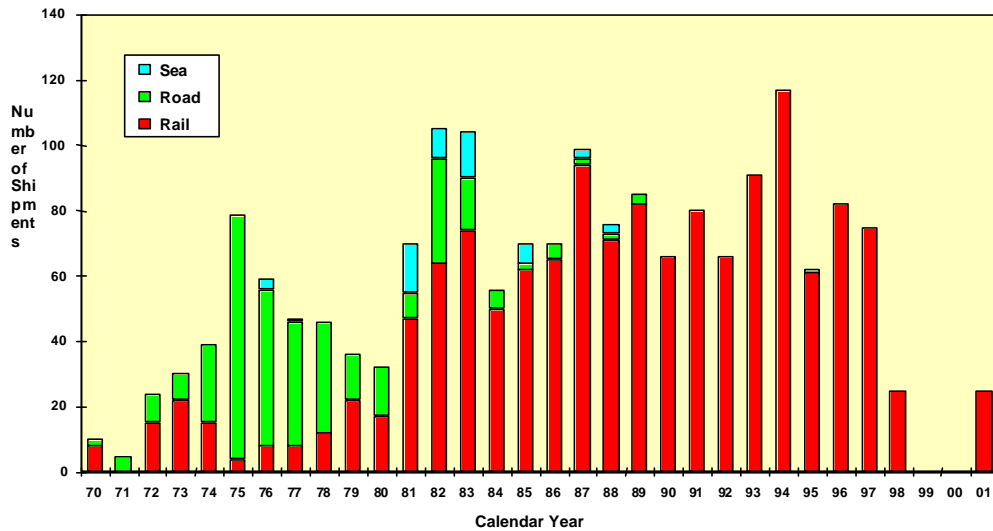

## 5.2 Exposure data

Exposure data were not readily available in some countries. In general public exposures were very low and for workers, most exposures were less than 1 mSv y<sup>-1</sup> apart from a few handler/drivers delivering radionuclides for medical purposes. Figure 4 shows the average dose (indicated by the horizontal line) and the dose range (indicated by the vertical line) to such workers in 8 countries.

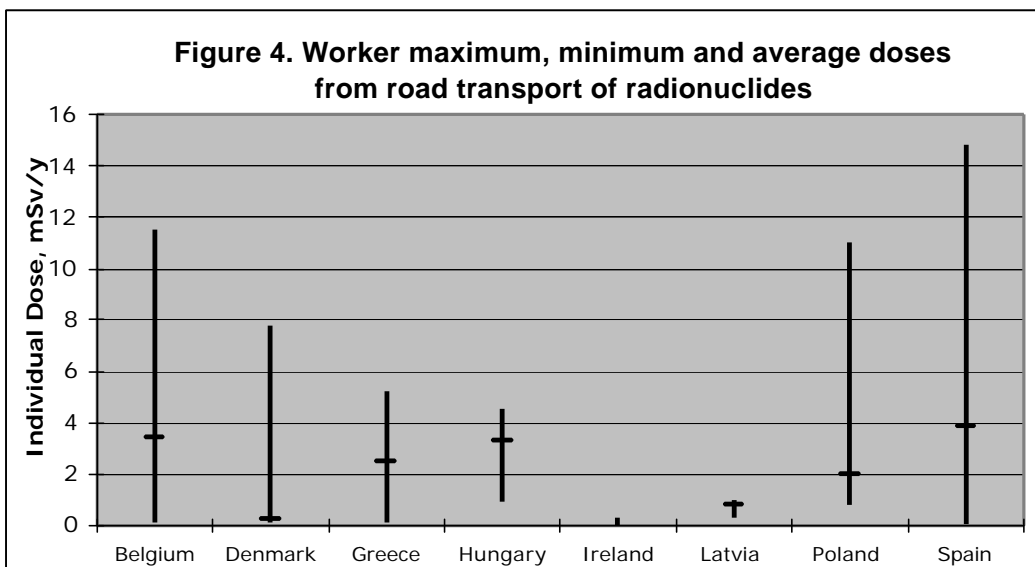

In some countries the Computer Code Intertran II [8] has been used to assess the collective dose to the public.

Tables 18 and 19 contain exposure data from Italy for 1996 - 2000 on doses to transport workers and collective doses per unit of Transport Index (TI).

Table 18: Annual effective dose for transport workers in Italy (1996 – 2000)

Year	No. Workers	Annual collective dose man mSv y <sup>-1</sup>	Average dose mSv y <sup>-1</sup>	Worker Dose	
				min mSv y <sup>-1</sup>	max
1996	399	203	0.508	0.024	5.3
1997	445	252	0.567	0.024	4.5
1998	489	341	0.698	0.019	7.2
1999	503	347	0.690	0.024	7.7
2000	456	461	1.011	0.01	5.4

Table 19: Annual collective dose and total TI in Italy (1996 – 2000)

Year	Total annual TI	Annual collective dose man mSv y <sup>-1</sup>	Collective radiation doses per unit TI man mSv y <sup>-1</sup>
1996	49830	203	0.004
1997	41075	252	0.006
1998	41213	341	0.008
1999	65995	347	0.005
2000	83011	461	0.005

In the UK classified worker doses are recorded on a Central Index of Dose Information (CIDI) [6]. Data for the years 1989- 2001 are given in Figure 5.

Figure 5. UK classified transport worker exposures (mSv) by year.

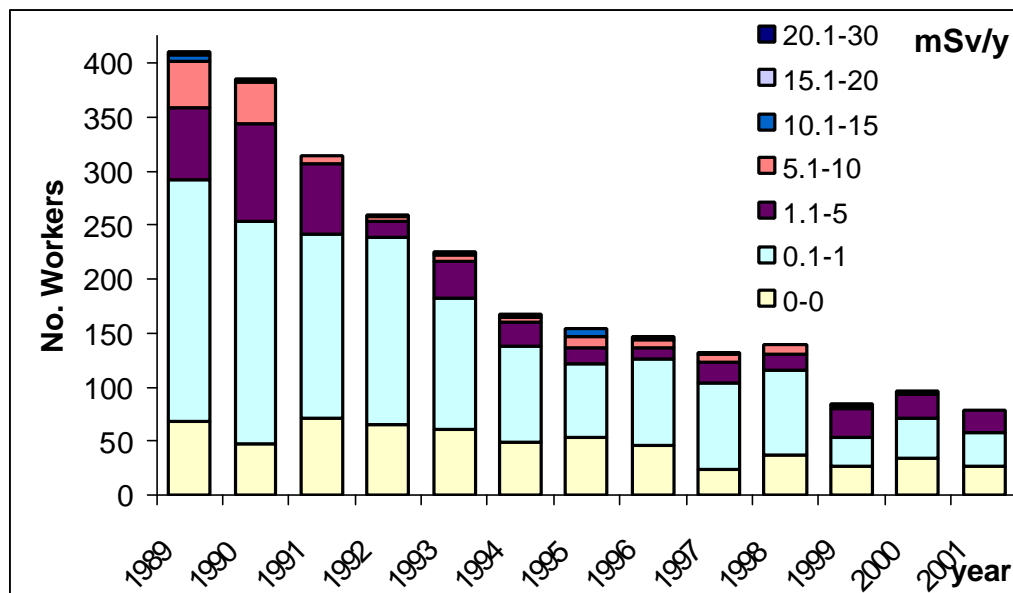

There has been a significant reduction in the number of workers receiving doses in the higher dose ranges. This indicates that operators have made efforts to improve radiological protection practice. The overall reduction in the number of classified workers in transport is a trend also observed



in other practices. One reason is the need to reduce the cost and administrative resources necessary for monitoring and controlling classified workers. However, many transport workers, although not classified, are still monitored even though the majority receive doses below  $1 \text{ mSv y}^{-1}$ .

Transport worker exposure data are generally low apart from a small number of workers involved with the supply of radiopharmaceuticals for medical use. The maximum exposures provided by 7 countries in response to this survey are shown in Figure 6.

**Figure 6. Occupational exposures arising from the transport of radioactive material in EU Member States**

Reported Maximum Transport Worker Radiation Doses (1990s/early 2000s)

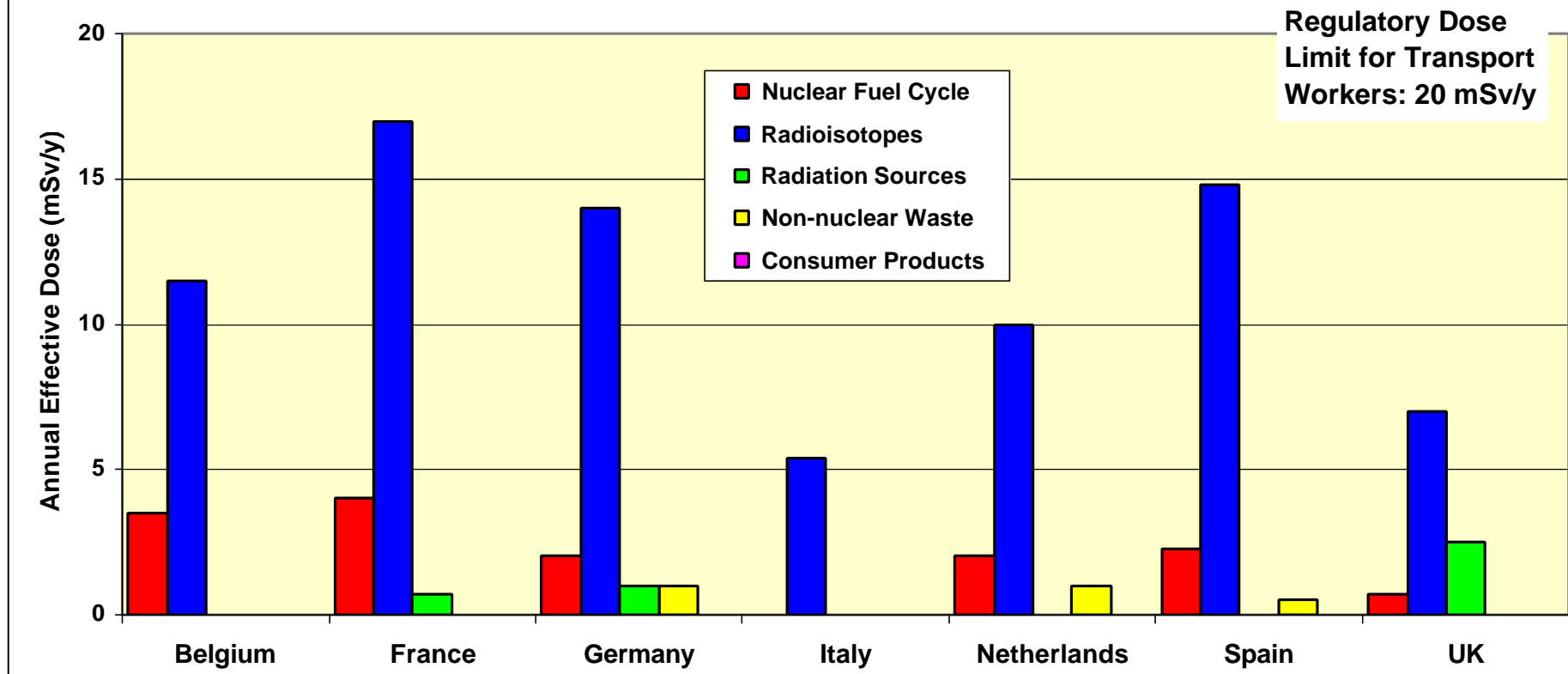

## 6. DISCUSSION AND COMMENT

---

This study presents the results of a survey to obtain information on the type and volume of radioactive material shipments in EU Member States and Applicant Countries and the radiation doses arising from such transports. The main method of data collection and compilation was through the use of a questionnaire developed within this EU project. The transport and exposure survey results cover those countries that provided data and responded to the questionnaire.

The latest available transport and exposure data were sought and generally provided for the late 1990s and early 2000s. The scope and level of detail of transport-related information varied and was generally broader for contractor countries (France, Germany, Italy, Netherlands, UK) than for non-contractor and applicant countries. The data provided relate to all relevant shipping modes (road, rail, air and sea) and all major categories of radioactive materials. The data, although not complete, represent the most comprehensive and consistent up-to-date information currently available concerning the type and magnitude of radioactive material shipments and resulting exposures in EU Member States and Applicant Countries.

The statistical shipment data available indicate that the domestic and international traffic of radioactive material shipments vary significantly between countries. Packages transported vary from a few hundred packages annually in some small countries up to several hundred thousand packages or containers annually in larger EU Member States. The presence of an established nuclear power generation programme has an important bearing on the volume of radioactive material shipments as does the presence of a major producer or commercial supplier of radioisotopes for medical, scientific and general industrial uses.

The transport survey results available clearly indicate that over a million packages of radioactive material have been shipped annually in the recent years in the European Union and its Applicant Countries. The majority of these shipments consists of radiopharmaceuticals and other radionuclides for scientific and general industrial applications. Fuel cycle shipments represent only a small fraction of the total radioactive material shipments but are generally the largest contribution to the activity transported. Similarly, radioactive material package shipments taking the form of portable radiographic or gauging radiation sources represent a small proportion of the national volumes of shipments of radioactive materials.

Road transport is the predominant shipping mode for all categories of radioactive materials. A significant fraction of the radioactive materials transports of the major user and supplier countries are transboundary shipments between EU Member States.

The shipment data from each country are collected and presented in different ways making inter-comparisons sometimes either very difficult or impossible. Care needs to be exercised in the use and interpretation of some of the data, for example that on consumer product shipments.

For some operations, for example industrial radiography or thickness gauging, the number of shipments and the number of packages are likely to be comparable. A single package is transported in each shipment. However, most packages are only transported once from producer to user and often as multiple packages in a single consignment.

The terminology used to describe the movement of radioactive materials by the various means of transport is unfortunately not uniquely defined in the transport community. In particular the definition of the term "shipment" is essentially left to the discretion of the consignor or carrier.<sup>3</sup> For example, a lorry carrying a large number of radiopharmaceutical packages destined for different consignees may be considered either as a single multiple-package shipment or as differing shipments of packaged radioactive materials for various consignees being carried on the same vehicle and counted accordingly as multiple radioactive material shipments. In the questionnaire developed in this study the term "shipment" has been used to denote the carriage of radioactive material from the consignor to the intermediate/final destination by a specific means of transport as specified in the transport document. A so-defined radioactive material shipment may consist of a single package/ container or of multiple packages/ containers.

Reliable statistical shipment data for monitoring long-term trends have been found to be scarce in most EU Member States and Applicant Countries. However, the Italian domestic regulations facilitate the establishment of long-term trend data and allows Italy to have available very detailed data on shipments of radioactive material over many years. The radiation protection regulations establish that carriers authorised to transport radioactive materials have to provide to the Competent Authority, on a quarterly basis, data regarding each shipment. Since 1987, using the data available, a database has been established containing data on the shipments of radioactive material for all modes of transport.

In Italy there has been an increase in the percentage of packages of category II-Yellow and III-Yellow shipped in the period 1997–2000. The reasons for this increase and for the increase of the total TI shipped are that there has been an increase in the average activity transported in a single package and an increase in the use of radionuclides with more penetrating radiations, for example Tc-99 for medical diagnostic use. However in spite of the increase in the average activity in a single package in the period 1997 – 2000, the package activity inventory for Excepted packages and Type A packages expressed in units of  $A_2$  was

---

<sup>3</sup> The Transport Regulations define shipment as the specific movement of a consignment from origin to destination.

very low. A single Excepted package or Type A package generally contains a small fraction of the activity limits, in units of  $A_2$ , allowed by the Transport Regulations.

In some countries the transport volume of radioactive material by rail and air has declined in recent years; in particular German Railways (DB) no longer accepts individual radioactive material packages (Stückgut, Expressgut) for transport by rail unless they are shipped as complete railcar loads. Likewise British Airways and KLM no longer accept packages of radioactive materials.

Exposure data available from various countries demonstrate that transport worker exposures are generally low in most transport operations, the majority of doses are below  $1 \text{ mSv y}^{-1}$ . However for drivers/handlers involved with the transport of radionuclides for medical/research uses, a small number of workers receive doses up to a significant fraction of the dose limits. A number of countries reported doses of the order of  $10 \text{ mSv}$  for these workers. Public radiation exposures received from the transport of radioactive substances in the public domain are typically very low, with most returns stating that doses were below  $0.1 \text{ mSv y}^{-1}$  for critical groups.

For radiological protection purposes the package radiation dose rate is limited to levels allowed under the Regulations, but experience indicates that most packages of radioactive material have radiation levels and radionuclide inventories well below the regulatory limits [3, 4]. In addition, the transport regulations require consignors/shippers of radioactive materials to provide an acceptable level of control of the radiation exposure to persons, property and the environment and to optimize safety and protection to levels "as low as reasonably achievable". Radiation Protection Programmes [9] are an important requirement to achieve best practice in transport operations.

In transport operations it is normal to apply good practice and sound management principles. Nevertheless, there is no room for complacency in optimization of protection and safety of people, property and the environment. Future possible developments, both in operational procedures and in equipment used for transport and handling should be considered. Sometimes improvements in safety and protection can be achieved effectively and at very little cost. Transport operators should establish regular reviews of their methods of work and equipment.

The availability of up-to date information on the type and volume of radioactive material transport and related exposure data plays an important role in these regular reviews. Data should be regularly examined and updated to ensure that a sound basis of monitoring trends in transport exists. Guidance should be given on the evaluation of the associated radiological risks.

Further attention should be paid to the need for and co-operation between operators and Competent Authorities to ensure that operators,

especially the smaller ones, are fully aware of, and understand, their legal responsibilities and obligations.

Co-operation between operators and national, European and international organisations with responsibilities for the safe transport of radioactive material will promote the implementation and application of good practices and sound management principles and criteria in the transport of hazardous material including radioactive substances, both in a growing European Union and internationally.

## **7. RECOMMENDATIONS AND CONCLUSIONS**

---

Data on shipments of radioactive materials and resulting exposures have been obtained, where possible, for EU Member States and Applicant Countries. The data cover 14 EU Member States and 11 Applicant Countries.

Currently there are no standard systems for collecting shipment and exposure data. The data presented in this report are the first attempt to produce a shipment and exposure database: there are gaps and differences in the data. The following recommendations and conclusions will assist with the future developments of the database:

- Harmonisation of systems for obtaining shipment and exposure data.
- Agreement on terminology.
- Agreement on the frequency for collecting such data.
- Support for a centralised system.

From the transport and exposure data analysed in this study the following conclusions can be drawn:

- Data collection, compilation and analysis can be time-consuming. A basic system for collecting such data should be developed. The questionnaire used in this study is a starting point.
- Shipment and exposure data are often preliminary and such data need to be checked. This is not a "one of" process but very much an ongoing process.
- Shipment data can change from year to year. In particular consignors and carriers may start or cease operations.
- Most radioactive material packages are only used once. However in some operations, for example industrial radiography and thickness gauging, the same package is shipped many times.

- Type A and Excepted packages are the most frequently transported package types.
- Over 1 million packages of radioactive materials, primarily for use in medicine, research and industry, are transported each year in Member States. A major fraction of these radioactive material transports are transboundary shipments.
- The highest number of shipments is by road.
- A small number of workers receive doses up to about  $15 \text{ mSv y}^{-1}$  although most worker doses are in the range of or less than  $1 \text{ mSv y}^{-1}$ . The highest exposures are associated with the transport of radionuclides for medical, scientific and industrial uses.
- Exposures of members of the public are trivial and represent only a minuscule fraction of the relevant dose limit.

This study brings together data on shipments of radioactive materials, and radiation exposures, from the Member States of the EU and the Applicant Countries. These data are not required to be notified to a central organisation in most of these countries. The data had to be obtained directly from the main sources within each country. Therefore, for some countries, the data is very comprehensive and for others, it is rather incomplete. Never the less the results of the study represent the most up to date compilation available. The benefit to the EC and EU in obtaining these data is that this information forms a basis on which to judge the relative importance of the types of materials being shipped, and modes of transport being used. Information of exposure data shows that the highest doses tend to be received by handlers/ drivers that transport radionuclides for medical purposes. Some of the data collected allow trends to be determined with time. This information could also be used to guide the development and application of any proposed legislation. Overall, the study found that exposures of transport workers are generally low, and exposures of members of the public from these practices are extremely low. The level of safety being achieved in this area is therefore shown to be high. However, this situation could change if controls are not rigorously applied and so these practices should be kept under review.

## **8. ACKNOWLEDGEMENTS**

---

The authors are grateful to all of the contacts in EU Member States and Applicant Countries who supplied transport and exposure data. Many individuals and organisations supplied information and their assistance has been most valuable.

## 9. REFERENCES

---

1. Regulations for the Safe Transport of Radioactive Material 1996 Edition (Revised), IAEA Safety Standards Series No. TS-R-1 (ST-1, Revised), IAEA Vienna, 2000.
2. Lange, F. et al., Assessment of the Radiological Risks of Road Transport Accidents involving Type A Packages, Final Report (EC Contract No. 4.1020/D/96-002 (DG XVII)), Oct. 1998
3. van Hienen, J.F.A. (Ed.), The Evaluation of the Situation in the European Community (EC) as regards Safety in the Transport of Radioactive Material and the Prospects for the Development of such Type of Transport, Revised Final Report (EC Contract No. 4.1020/D/97-003 (DG XVII)), Feb. 1999
4. Raffestin, D. et al., Evaluation of the Radiation Protection Options related to the Transport of Low Weight Packages - Category III-YELLOW, Final Report (EC Contract No. 4.1020/D/96-014 (DG XVII)), Jan. 1998
5. Gelder, R. et al., Transport of Consumer Goods containing Small Quantities of Radioactive Materials, Final Report (EC Contract No. 4.1020/D/99-006 (DG TREN)), Mar. 2001
6. Central Index of Dose Information. Summary of Statistics for 1989, London, HSE, 1990. [Also separate publications for years to 2000]
7. Palmieri, G. and Trivelloni, S. TRARAD: The Italian database on the shipments of radioactive material, RAMTRANS, Vol. 10, No.1, pp. 31-36, Nuclear Technology Publishing, 1999.
8. AMC Konsult AB, INTERTRAN 2, Transportation Risk Assessment Package.
9. IAEA Guidance on Radiation Protection Programmes in transport. To be published.



## 10. GLOSSARY OF TERMS

---

**ANPA.** Agenzia Nazionale per la Protezione Dell'Ambiente, Via Vitaliano, Bracanti 48, 00144 Rome, Italy

**A1 and A2.** A1 is the activity limit of special form material in a Type A package. A2 is the activity limit for other than special form material in a Type A package.

**CEPN.** Centre d'Etude sur l'Evaluation de la Protection dans le domaine Nucleaire (CEPN), BP 48, F-92263 Fontenay-aux-Roses, France

**Collective effective dose.** Abbreviated to collective dose. The quantity obtained by multiplying the average effective dose by the number of people exposed.

**Effective dose.** The quantity obtained by multiplying equivalent dose to various organs by appropriate weighting factors and summing the products.

**Excepted package.** A basic package meeting minimum specified regulatory requirements.

**GRS.** Gesellschaft fuer Anlagen- und Reaktorsicherheit (GRS) mbH, Schwertnergasse 1, 50667 Cologne, Germany

**Industrial package.** A package of higher integrity than for an Excepted package and meeting the requirements in the regulations.

**IRSN.** Institut de Radioprotection et de Surete Nucleaire, BP 17, F-92265 Fontenay-aux-Roses, France

**NRG.** Nuclear Research and Consultancy Group, Westerduinweg 3, Petten, The Netherlands

**NRPB.** National Radiological Protection Board, Chilton, Didcot, Oxon OX11 0RQ, UK

**TI.** Transport Index is a number equal to the maximum dose rate, at 1m from the surface of a package, overpack or freight container, measured in mSv/h times 100.

**Type A package.** A package expected to withstand normal handling conditions and to meet the specifications in the regulations.

**Type B package.** A package expected to withstand severe accident conditions and to meet the requirements specified in the regulations.

## **Appendix 1**

### **Example of letter to Authorities.**

Mr. Jaan Saar

Ministry of Environment

Rõvola 8

TALLINN

EE - 10143

Estonia

Dear Mr. Saar,

The Directorate General for Energy and Transport (DG TREN) of the European Commission has sponsored a study on shipments of radioactive materials in the European Union and in the countries applying for accession to the EU. The study will involve the collection and compilation of information on the type, volume and radiological characteristics of radioactive material shipments, together with the radiation doses arising from these shipments.

The study is being performed under contract to the EC, by organisations from five EU countries: NRPB (United Kingdom), GRS (Germany), IPSN/CEPN (France), ANPA (Italy) and NRG (Netherlands).

We intend to collect information from EU Member States, and applicant countries, mainly by using a questionnaire. This questionnaire will be sent to you soon for completion, and we would greatly appreciate your help in providing information on this subject. It is important that we are able to obtain some information from all Member States and applicant countries. This will enable us to perform a comprehensive analysis of shipments of radioactive materials and exposures from transport operations in these countries.

In the meantime, could you please return, as soon as possible, the enclosed form, which has some basic preliminary questions.

If you are not the appropriate person to deal with this matter could you please inform us of a more appropriate contact on the enclosed form.

### ***Background to the study***

The Council Decision 1999/25/EC, Euratom, of 14 December 1998 adopted a multiannual programme (1998 - 2002) for actions in the nuclear sector, including actions on the safe transport of radioactive material. This study is being supported under these actions. The information being sought in the study on the transport of radioactive material is important to:

- demonstrate the efficacy of the international Transport Regulations of the International Atomic Energy Agency (IAEA),
- provide support for the continuous review and revision process of the international Transport Regulations,
- support and guide compliance assurance,
- provide data for assessing and evaluating the doses and risks to workers and to members of the public,
- identify needs and trends in international transport activities,
- provide factual information to assist in addressing questions and safety concerns of the European Parliament, the public and the media.

The information collected will be analysed and a full report will be produced and subsequently made available to all EU Member States and Applicant Countries. The analyses will be, for example, by:

- Type of package,
- type of transport,
- radiation exposures to workers and members of the public,
- use of the radioactive material.

The study was described in presentations to the IAEA's Transport Safety Standards Committee on 7<sup>th</sup> March, 2002, and to the 35<sup>th</sup> Meeting of the EC's Standing Working Group on the Transport of Radioactive Materials on the 19<sup>th</sup> March, 2002.

The study is being co-ordinated by the National Radiological Protection Board (NRPB). If you have any initial questions relating to the study, please contact us by using the information on the enclosed form.

Thank you for assistance in these matters.

Yours sincerely,

Mr K. B. Shaw  
Exposure Estimation Group  
Environmental Assessments Department

**Statistics on the Transport of Radioactive Materials**

**Preliminary information**

From: Mr. Jaan Saar  
Ministry of Environment  
Rõvola 8  
TALLINN  
EE - 10143  
Estonia

I am the appropriate contact for the information required by this study:  
Yes/No

If another person/ organisation is a more appropriate contact for this information, please give contact details here:

Name: \_\_\_\_\_

Address: \_\_\_\_\_

\_\_\_\_\_  
\_\_\_\_\_  
\_\_\_\_\_  
\_\_\_\_\_

Telephone: \_\_\_\_\_

Fax: \_\_\_\_\_

E-mail address: \_\_\_\_\_

Please return this form by mail **as soon as possible** to:

Mrs S. M. Warner Jones  
NRPB  
Chilton,  
Didcot,  
Oxfordshire  
United Kingdom OX11 0RQ

or by Fax to: (00)44-1235-833891  
or send the information above by E-mail to:  
**sarah.jones@nrpb.org**

## Appendix 2

### **General guidance on the use and application of the questionnaire form for the collection and compilation of information on the type and magnitude of radioactive material shipment and exposure data in EU Member States and Applicant Countries**

On request of the European Commission (DG TREN) a multi-national research project (C4/TMR2001/300-1) involving scientific organisations from five EU Member States is currently underway aiming at the collection, compilation and analysis of information on the type and magnitude of radioactive material shipments in EU Member States and Applicant Countries. To facilitate the gathering and reporting of radioactive material shipment and radiation exposure data two questionnaire forms are provided (attached to this guidance note): **Part I** relating to the radioactive material shipment data and **Part II** relating to the transport-related exposure data being reported by a particular country.

Guidance is provided below on the use and completion of the related questionnaire forms, to ensure uniformity and consistency in the way of data reporting and the understanding of the terminology and definitions used in the forms for the collection and compilation of the relevant statistical transport and exposure data.

The EU-funded radioactive material transport survey relates to all categories of radioactive material ranging from very low to very large quantities of radioactive materials, e.g. spent nuclear fuel, with emphasis on those falling in the realm of the IAEA Transport Regulations. In addition attempts are being made - where available - to collect and compile statistical transport data related to low-level consumer products which may or may not be subject to the safety requirements of the Regulations. For the purpose of the transport data survey the broad range of radioactive materials in use worldwide has been broken down somewhat arbitrarily in **five** broad categories of radioactive materials and associated transport operations: nuclear fuel cycle materials; radioisotopes for medicine, research and industry; Radiographic and gauging/monitoring radiation sources, non-nuclear radioactive wastes, and consumer products, with each category encompassing a variety of sub-groups.

The European-wide transport data survey encompasses all categories of radioactive material shipments being moved within or beyond the boundaries of the territory of a given country, i.e. domestic, transboundary and transit shipments, but with the exception of radioactive material being moved within an establishment at fixed sites.

The statistical transport data required from the reporting EU Member State or applicant country should preferably relate to the **calendar year 2001**. If such up-to-date transport data is not available or is incomplete

on a national basis, then annual statistical transport data for the latest available period is acceptable. This should be given for the various fields of application of radioactive materials specifying the relevant reporting period (calendar year) in the questionnaire.

Throughout the questionnaire the term “**shipment**” is used to denote the carriage of a consignment of radioactive materials in the public domain of the reporting country from the point of origin to the final (or intermediate) destination as specified in the related transport documents. Consequently a shipment may consist either of single or multiple materials, packages, freight containers or conveyances (e.g. three railcars each carrying two freight containers). The **number and type of radioactive material packages** are also specified in the transport documents (or may be inferred from the UN number) and described consistent with the definition of the relevant Regulations and can take the form of either excepted, Type IP, Type A, Type B or Type C packages. Other than many point-to-point radioactive material transports shipments of portable radiation sources are generally “roundtrips”. Starting point of a “roundtrip” is typically from the radiographer’s or user’s office/depot to the site(s) of application of the radiation source and from there onwards back to the user’s office/depot. Each roundtrip should be considered as a single shipment and recorded appropriately, with the average number of radiation sources aboard the conveyance during a “roundtrip” being given in the questionnaire.

Although it is recognised that the conditions and modes of transport vary widely among countries, including mixed modes, emphasis in this European-wide transport data survey is on the predominant mode of transport for a given material category in a reporting EU Member State or applicant country. Therefore only one mode-of-transport field should be marked for each radioactive material shipment category.

Data fields of the questionnaire form which are not relevant for a given country or where data are lacking should be marked either as “n.r.” = not relevant or “n.a.” = not available.

It is acknowledged that the level of information on radiation exposures to transport workers and the public arising from routine transport operations vary widely, depending, for example, on the number of radioactive materials shipments being carried out nationally, the field of transport and the relevant transport mode. In some areas, e.g. transport operations involving primarily consumer products, exposure data may be completely lacking.

In areas where routine (accident-free) transport exposure data are available the relevant radiation doses should preferably be provided for two population groups in terms of the **average** effective dose per year and/or as **minimum/maximum-values** in units of mSv/y: (a) transport workers, e.g. driver, package handler, marshalling yard personnel etc. and (b) members of the public (critical group), e.g. persons along routes or at stops, aircraft passengers etc. More details on the specific type of

work or population group will be appreciated under "Remarks" or by provision of additional material or references.

**Final remarks**

Any queries or requests for additional information related to this EU-funded multi-national research project or questionnaire form should be directed to:

**National Radiological Protection Board (NRPB)**

Att.: K.B. Shaw (Project co-ordinator)

**Chilton, Didcot, Oxfordshire OX11 0RQ, United Kingdom (UK)**

[E-mail: [ken.shaw@nrpb.org](mailto:ken.shaw@nrpb.org)]

**Survey on the Type and Magnitude of Radioactive Material Shipments in the Public Domain of EU Member States and Applicant Countries: Part I**

Reporting Country: .....

Reporting Year: .....

	Radioactive Material	Annual transport volume		Predominant transport mode			
		Number of Shipments per Year	Number of Packages per Year	Road	Rail	Air	Sea
<b>Fuel Cycle Material:</b>							
	- Irradiated fuel assemblies, fuel pins (UO <sub>2</sub> , MOX)						
	- Non-irradiated fuel assemblies, fuel pins (UO <sub>2</sub> , MOX)						
	- Uranium/thorium ore						
	- Pre-fuel material (UOC, U <sub>3</sub> O <sub>8</sub> , UO <sub>2</sub> , MOX, pellets etc.)						
	- Uranium Hexafluoride (UF <sub>6</sub> )						
	- Vitrified radioactive waste						
	- Low-/intermediate-level radioactive waste (LLW/ILW)						
	- Unloaded (empty) flasks						
	- Others (samples, components, monitoring equipment etc.)						
<b>Radioisotope Supply and Distribution:</b>							
	- Type B packages						
	- Type A packages						
	- Excepted packages						
	- Others						



**Survey on the Type and Magnitude of Radioactive Material Shipments in the Public Domain of EU Member States and Applicant Countries: Part I (Continued)**

Radioactive Material	Annual transport volume		Predominant transport mode			
	Number of Shipments per Year	Number of Packages per Year	Road	Rail	Air	Sea
<b><u>Radiation Sources:</u></b>						
- Radiographic radiation sources						
- Nuclear density/portable gauging devices						
- Others						
<b><u>Non-nuclear Radioactive Wastes</u></b>						
- Medical / research wastes						
- Industrial wastes						
- Others (specify)						
<b><u>Consumer Products</u></b>						
- Smoke detectors						
- Radioluminescent products						
- Lighting products						
- Others (specify)						

**Survey of Occupational and Public Radiation Exposures arising from Radioactive Material Package Shipments in EU Member States and Applicant Countries:**  
**Part II**

Reporting Country: .....

Reporting Year: .....

	Transport Operations	<u>Annual effective Dose (mSv/y)</u>				Remarks
		Transport Workers		Public (Critical group)		
		<u>Avg.</u>	<u>min./max.</u>	<u>Avg.</u>	<u>min./max.</u>	
	<b><u>Nuclear Fuel Cycle</u></b>					
	- Road					
	- Rail					
	- Air					
	- Sea					
	<b><u>Radioisotope Supply and Distribution</u></b>					
	- Road					
	- Rail					
	- Air					
	<b><u>Radiation Sources</u></b>					
	- Radiography					
	- Nuclear density/gauging devices					
	<b><u>Non-nuclear Wastes</u></b>					
	- Medical/research/industry (specify)					
	<b><u>Consumer Products</u></b>					
	Road/Rail/Air/Sea (specify)					
	If available give additional details, references etc. under remarks or on a separate page					

**Appendix 3 Shipment and Exposure data from member states and applicant countries**

Reporting Country: Austria

Reporting Year: 2001

Radioactive Material	Annual transport volume		Predominant transport mode			
	N° Shipments per Year	N° Packages per Year	Road	Rail	Air	Sea
<b>Fuel Cycle Material:</b>						
Irradiated fuel assemblies, fuel pins (UO2, MOX)	1	2	x	x		x
Non-Irradiated fuel assemblies, fuel pins (UO2, MOX)						
Uranium/thorium ore						
Pre-fuel material (UOC, U3O8, UO2, MOX, pellets etc.)						
Uranium Hexafluoride (UF6)						
Vitrified radioactive waste						
Low-/intermediate-level radioactive waste (LLW/ILW)	3	9	x			
Unloaded (empty) flasks						
Others (samples, components, monitoring equipment etc.)	3	1	x		x	
<b>Radioisotope Supply and Distribution:</b>						
Type B packages	1100	70	x	x	x	
Type A packages	10200	1000	x	x	x	
Excepted packages	200	2000	x			
Others						
<b>Radiation Sources:</b>						
Radiographic radiation sources	1000	60	x			
Nuclear density/portable gauging devices	200	10	x			
Others	100	100	x	x		
<b>Non-nuclear Radioactive Wastes</b>						
Medical / research wastes	30	1500	x			
Industrial wastes	10	20	x			
Others						
<b>Consumer Products</b>						
Smoke detectors	10	10	x			
Radioluminescent products	2	2	x			
Lighting products						
Others (specify)						

Reporting Country: Belgium

Reporting Year: 2001

Radioactive Material	Annual transport volume		Predominant transport mode			
	N° Shipments per Year	N° Packages per Year	Road	Rail	Air	Sea
<b>Fuel Cycle Material:</b>						
Irradiated fuel assemblies, fuel pins (UO <sub>2</sub> , MOX)	151	316	x	x		
Non-Irradiated fuel assemblies, fuel pins (UO <sub>2</sub> , MOX)	266	1170	x	x		x
Uranium/thorium ore	0	0				
Pre-fuel material (UOC, U <sub>3</sub> O <sub>8</sub> , UO <sub>2</sub> , MOX, pellets etc.)	349	87029	x	x		x
Uranium Hexafluoride (UF <sub>6</sub> )	244	2534	x	x		x
Vitrified radioactive waste	1	1	x	x		
Low-/intermediate-level radioactive waste (LLW/ILW)	422	2820	x			
Unloaded (empty) flasks	30	54	x	x		x
Others (samples, components, monitoring equipment etc.)	252	2238	x		x	x
<b>Radioisotope Supply and Distribution:</b>						
Type B packages	3412	6419	x		x	
Type A packages	33539	360522	x		x	x
Excepted packages	7978	56386	x		x	x
Others						
<b>Radiation Sources:</b>						
Radiographic radiation sources	7203	7643	x			
Nuclear density/portable gauging devices	814	893	x			
Others – Industrial irradiators and radiotherapy sources	25	28	x			x
<b>Non-nuclear Radioactive Wastes</b>						
Medical / research wastes	470	11346	x			
Industrial wastes	6	330	x			
Others	203	723	x			
<b>Consumer Products</b>						
Smoke detectors	na	na				
Radioluminescent products	na	na				
Lighting products	na	na				
Others – Natural Ores	34	4706				x

Reporting Country: Denmark

Reporting Year: 2001

Radioactive Material	Annual transport volume		Predominant transport mode			
	N° Shipments per Year	N° Packages per Year	Road	Rail	Air	Sea
<b>Fuel Cycle Material:</b>						
Irradiated fuel assemblies, fuel pins (UO2, MOX)			0			
Non-Irradiated fuel assemblies, fuel pins (UO2, MOX)			1	x		
Uranium/thorium ore			0			
Pre-fuel material (UOC, U3O8, UO2, MOX, pellets etc.)			0			
Uranium Hexafluoride (UF6)			0			
Vitrified radioactive waste			0			
Low-/intermediate-level radioactive waste (LLW/ILW)			6	x		
Unloaded (empty) flasks			NA			
Others (samples, components, monitoring equipment etc.)						
<b>Radioisotope Supply and Distribution:</b>						
Type B packages			5000	x		
Type A packages			25000	x		
Excepted packages			20000	x		
Others						
<b>Radiation Sources:</b>						
Radiographic radiation sources			5000	x		
Nuclear density/portable gauging devices			1000	x		
Others						
<b>Non-nuclear Radioactive Wastes</b>						
Medical / research wastes			50	x		
Industrial wastes			20	x		
Others						
<b>Consumer Products</b>						
Smoke detectors			10000	x		
Radioluminescent products			10	x		
Lighting products			50	x		
Others (specify)						

Reporting Country: Finland

Reporting Year: 2001

Radioactive Material	Annual transport volume		Predominant transport mode			
	N° Shipments per Year	N° Packages per Year	Road	Rail	Air	Sea
<b>Fuel Cycle Material:</b>						
Irradiated fuel assemblies, fuel pins (UO <sub>2</sub> , MOX)	1	1	x			
Non-Irradiated fuel assemblies, fuel pins (UO <sub>2</sub> , MOX)	3	171	x			
Uranium/thorium ore						
Pre-fuel material (UOC, U <sub>3</sub> O <sub>8</sub> , UO <sub>2</sub> , MOX, pellets etc.)						
Uranium Hexafluoride (UF <sub>6</sub> )						
Vitrified radioactive waste						
Low-/intermediate-level radioactive waste (LLW/ILW)						
Unloaded (empty) flasks						
Others (samples, components, monitoring equipment etc.)						
<b>Radioisotope Supply and Distribution:</b>						
Type B packages	30	80			x	
Type A packages	3900	7800			x	
Excepted packages	3100	11500			x	
Others						
<b>Radiation Sources:</b>	1000	1000	x			
Radiographic radiation sources						
Nuclear density/portable gauging devices						
Others						
<b>Non-nuclear Radioactive Wastes</b>	40	70	x			
Medical / research wastes						
Industrial wastes						
Others						
<b>Consumer Products</b>	na	na				
Smoke detectors						
Radioluminescent products						
Lighting products						
Others (specify)						

Reporting Country: Greece

Reporting Year: 2001

Radioactive Material	Annual transport volume		Predominant transport mode			
	N° Shipments per Year	N° Packages per Year	Road	Rail	Air	Sea
<b>Fuel Cycle Material:</b>	nr	nr				
Irradiated fuel assemblies, fuel pins (UO2, MOX)						
Non-Irradiated fuel assemblies, fuel pins (UO2, MOX)						
Uranium/thorium ore						
Pre-fuel material (UOC, U3O8, UO2, MOX, pellets etc.)						
Uranium Hexafluoride (UF6)						
Vitrified radioactive waste						
Low-/intermediate-level radioactive waste (LLW/ILW)						
Unloaded (empty) flasks						
Others (samples, components, monitoring equipment etc.)						
<b>Radioisotope Supply and Distribution:</b>						
Type B packages	7	7	x			
Type A packages	2500	40000	x			
Excepted packages	2500	100000	x			
Others						
<b>Radiation Sources:</b>						
Radiographic radiation sources	51	60	x			
Nuclear density/portable gauging devices	4	4	x			
Others	4	4	x			
<b>Non-nuclear Radioactive Wastes</b>						
Medical / research wastes	5	5			x	
Industrial wastes	1	1			x	
Others						
<b>Consumer Products</b>						
Smoke detectors	10	na	x			
Radioluminescent products						
Lighting products						
Others (specify)						

Reporting Country: Ireland

Reporting Year: 2001

Radioactive Material	Annual transport volume		Predominant transport mode			
	N <sup>o</sup> Shipments per Year	N <sup>o</sup> Packages per Year	Road	Rail	Air	Sea
<b>Fuel Cycle Material:</b>						
Irradiated fuel assemblies, fuel pins (UO <sub>2</sub> , MOX)	nr	nr				
Non-Irradiated fuel assemblies, fuel pins (UO <sub>2</sub> , MOX)	nr	nr				
Uranium/thorium ore	nr	nr				
Pre-fuel material (UOC, U <sub>3</sub> O <sub>8</sub> , UO <sub>2</sub> , MOX, pellets etc.)	nr	nr				
Uranium Hexafluoride (UF <sub>6</sub> )	nr	nr				
Vitrified radioactive waste	nr	nr				
Low-/intermediate-level radioactive waste (LLW/ILW)	nr	nr				
Unloaded (empty) flasks	nr	nr				
Others (samples, components, monitoring equipment etc.)	nr	nr				
<b>Radioisotope Supply and Distribution:</b>						
Type B packages	4	6				
Type A packages	1333	3118				
Excepted packages	996	1353				
Others - Industrial	1	1				
<b>Radiation Sources:</b>						
Radiographic radiation sources	1085	41				
Nuclear density/portable gauging devices	686	17				
Others	nr	nr				
<b>Non-nuclear Radioactive Wastes</b>						
Medical / research wastes	nr	nr				
Industrial wastes	nr	nr				
Others	nr	nr				
<b>Consumer Products</b>						
Smoke detectors	82	299				
Radioluminescent products	nr	nr				
Lighting products	nr	nr				
Others (specify)	nr	nr				



Reporting Country: Luxembourg

Reporting Year: 2001

Radioactive Material	Annual transport volume		Predominant transport mode			
	N° Shipments per Year	N° Packages per Year	Road	Rail	Air	Sea
<b>Fuel Cycle Material:</b>						
Irradiated fuel assemblies, fuel pins (UO <sub>2</sub> , MOX)						
Non-Irradiated fuel assemblies, fuel pins (UO <sub>2</sub> , MOX)						
Uranium/thorium ore						
Pre-fuel material (UOC, U <sub>3</sub> O <sub>8</sub> , UO <sub>2</sub> , MOX, pellets etc.)						
Uranium Hexafluoride (UF <sub>6</sub> )						
Vitrified radioactive waste						
Low-/intermediate-level radioactive waste (LLW/ILW)						
Unloaded (empty) flasks						
Others (samples, components, monitoring equipment etc.)						
<b>Radioisotope Supply and Distribution:</b>						
Type B packages						
Type A packages	10	10	x			
Excepted packages						
Others						
<b>Radiation Sources:</b>						
Radiographic radiation sources						
Nuclear density/portable gauging devices	10	10	x			
Others						
<b>Non-nuclear Radioactive Wastes</b>						
Medical / research wastes						
Industrial wastes						
Others						
<b>Consumer Products</b>						
Smoke detectors						
Radioluminescent products						
Lighting products						
Others (specify)						

Reporting Country: Spain

Reporting Year: 2001

Radioactive Material	Annual transport volume		Predominant transport mode			
	N° Shipments per Year	N° Packages per Year	Road	Rail	Air	Sea
<b>Fuel Cycle Material:</b>						
Irradiated fuel assemblies, fuel pins (UO <sub>2</sub> , MOX)	nr	nr				
Non-Irradiated fuel assemblies, fuel pins (UO <sub>2</sub> , MOX)	16	320	x			
Uranium/thorium ore	7	7	x			
Pre-fuel material (UOC, U <sub>3</sub> O <sub>8</sub> , UO <sub>2</sub> , MOX, pellets etc.)	24	3793	x			
Uranium Hexafluoride (UF <sub>6</sub> )	nr	nr				
Vitrified radioactive waste	nr	nr				
Low-/intermediate-level radioactive waste (LLW/ILW)	182	5980	x			
Unloaded (empty) flasks	nr	nr				
Others (samples, components, monitoring equipment etc.)	na	na				
<b>Radioisotope Supply and Distribution:</b>						
Type B packages	55	144			x	
Type A packages	14800	na	x			
Excepted packages	na	na				
Others						
<b>Radiation Sources:</b>						
Radiographic radiation sources	na	na	x			
Nuclear density/portable gauging devices	na	na	x			
Others	na	na				
<b>Non-nuclear Radioactive Wastes</b>	36	915	x			
Medical / research wastes						
Industrial wastes						
Others						
<b>Consumer Products</b>	na	na				
Smoke detectors						
Radioluminescent products						
Lighting products						
Others (specify)						

Reporting Country: Sweden

Reporting Year: 2001

Radioactive Material	Annual transport volume		Predominant transport mode			
	N <sup>o</sup> Shipments per Year	N <sup>o</sup> Packages per Year	Road	Rail	Air	Sea
<b>Fuel Cycle Material:</b>						
Irradiated fuel assemblies, fuel pins (UO <sub>2</sub> , MOX)	34	72				x
Non-Irradiated fuel assemblies, fuel pins (UO <sub>2</sub> , MOX)	49	670	x			
Uranium/thorium ore	nr	nr				
Pre-fuel material (UOC, U <sub>3</sub> O <sub>8</sub> , UO <sub>2</sub> , MOX, pellets etc.)	6	11	x			
Uranium Hexafluoride (UF <sub>6</sub> )	22	150	x			
Vitrified radioactive waste	nr	nr				
Low-/intermediate-level radioactive waste (LLW/ILW)	120	500	x			
Unloaded (empty) flasks	47	89				x
Others (samples, components, monitoring equipment etc.)	300	1000	x			
<b>Radioisotope Supply and Distribution:</b>						
Type B packages	71	121	x		x	
Type A packages	3000	12000	x		x	
Excepted packages	na	na				
Others						
<b>Radiation Sources:</b>	500	500	x			
Radiographic radiation sources						
Nuclear density/portable gauging devices						
Others						
<b>Non-nuclear Radioactive Wastes</b>						
Medical / research wastes	25	800	x			
Industrial wastes	100	100	x			
Others						
<b>Consumer Products</b>	na	na				
Smoke detectors						
Radioluminescent products						
Lighting products						
Others (specify)						

Reporting Country: Cyprus

Reporting Year: 2001

Radioactive Material	Annual transport volume		Predominant transport mode			
	N° Shipments per Year	N° Packages per Year	Road	Rail	Air	Sea
<b>Fuel Cycle Material:</b>						
Irradiated fuel assemblies, fuel pins (UO2, MOX)						
Non-Irradiated fuel assemblies, fuel pins (UO2, MOX)						
Uranium/thorium ore						
Pre-fuel material (UOC, U3O8, UO2, MOX, pellets etc.)						
Uranium Hexafluoride (UF6)						
Vitrified radioactive waste						
Low-/intermediate-level radioactive waste (LLW/ILW)						
Unloaded (empty) flasks						
Others (samples, components, monitoring equipment etc.)	5	7			x	
<b>Radioisotope Supply and Distribution:</b>	86	399			x	
Type B packages						
Type A packages						
Excepted packages						
Others						
<b>Radiation Sources:</b>						
Radiographic radiation sources						
Nuclear density/portable gauging devices						
Others						
<b>Non-nuclear Radioactive Wastes</b>						
Medical / research wastes						
Industrial wastes						
Others						
<b>Consumer Products</b>	na	na				
Smoke detectors						
Radioluminescent products						
Lighting products						
Others (specify)						

Reporting Country: Czech Republic

Reporting Year: 2001

Radioactive Material	Annual transport volume		Predominant transport mode			
	N <sup>o</sup> Shipments per Year	N <sup>o</sup> Packages per Year	Road	Rail	Air	Sea
<b>Fuel Cycle Material:</b>						
Irradiated fuel assemblies, fuel pins (UO <sub>2</sub> , MOX)	nr	nr				
Non-Irradiated fuel assemblies, fuel pins (UO <sub>2</sub> , MOX)	11	184	7	4		
Uranium/thorium ore	nr	nr				
Pre-fuel material (UOC, U <sub>3</sub> O <sub>8</sub> , UO <sub>2</sub> , MOX, pellets etc.)	7	4604		7		
Uranium Hexafluoride (UF <sub>6</sub> )	nr	nr				
Vitrified radioactive waste	nr	nr				
Low-/intermediate-level radioactive waste (LLW/ILW)	nr	nr				
Unloaded (empty) flasks	nr	nr				
Others (samples, components, monitoring equipment etc.)	14	14	14			
<b>Radioisotope Supply and Distribution:</b>	na	na				
Type B packages						
Type A packages						
Excepted packages						
Others						
<b>Radiation Sources:</b>	na	na				
Radiographic radiation sources						
Nuclear density/portable gauging devices						
Others						
<b>Non-nuclear Radioactive Wastes</b>						
Medical / research wastes	14	75	14			
Industrial wastes	7	40	7			
Others	nr	nr				
<b>Consumer Products</b>	na	na				
Smoke detectors						
Radioluminescent products						
Lighting products						
Others (specify)						

Reporting Country: Estonia

Reporting Year: 2001

Radioactive Material	Annual transport volume		Predominant transport mode			
	N° Shipments per Year	N° Packages per Year	Road	Rail	Air	Sea
<b>Fuel Cycle Material:</b>						
Irradiated fuel assemblies, fuel pins (UO2, MOX)	nr	nr				
Non-Irradiated fuel assemblies, fuel pins (UO2, MOX)	nr	nr				
Uranium/thorium ore	nr	nr				
Pre-fuel material (UOC, U3O8, UO2, MOX, pellets etc.)	nr	nr				
Uranium Hexafluoride (UF6)	nr	nr				
Vitrified radioactive waste	nr	nr				
Low-/intermediate-level radioactive waste (LLW/ILW)	nr	nr				
Unloaded (empty) flasks	nr	nr				
Others (samples, components, monitoring equipment etc.)	nr	nr				
<b>Radioisotope Supply and Distribution:</b>	na	na				
Type B packages	na	na				
Type A packages	na	na				
Excepted packages	na	na				
Others	na	na				
<b>Radiation Sources:</b>						
Radiographic radiation sources	2	2	x			
Nuclear density/portable gauging devices	2	3	x			
Others		337	x			
<b>Non-nuclear Radioactive Wastes</b>						
Medical / research wastes						
Industrial wastes						
Others	8	8	x			
<b>Consumer Products</b>						
Smoke detectors	na	na				
Radioluminescent products	na	na				
Lighting products	na	na				
Others (specify)						

Reporting Country: Hungary

Reporting Year: 2001

Radioactive Material	Annual transport volume		Predominant transport mode			
	N° Shipments per Year	N° Packages per Year	Road	Rail	Air	Sea
<b>Fuel Cycle Material:</b>						
Irradiated fuel assemblies, fuel pins (UO <sub>2</sub> , MOX)	0	0		x		
Non-Irradiated fuel assemblies, fuel pins (UO <sub>2</sub> , MOX)	3	55		x		
Uranium/thorium ore	nr	nr				
Pre-fuel material (UOC, U <sub>3</sub> O <sub>8</sub> , UO <sub>2</sub> , MOX, pellets etc.)	0	0				
Uranium Hexafluoride (UF <sub>6</sub> )	nr	nr				
Vitrified radioactive waste	nr	nr				
Low-/intermediate-level radioactive waste (LLW/ILW)	nr	nr				
Unloaded (empty) flasks	nr	nr				
Others (samples, components, monitoring equipment etc.)	nr	nr				
<b>Radioisotope Supply and Distribution:</b>	5047	14323		x		
Type B packages		230	x			
Type A packages		11430		x		
Excepted packages		3612		x		
Others		51	x			
<b>Radiation Sources:</b>						
Radiographic radiation sources	15	15	x			
Nuclear density/portable gauging devices	1	1	x			
Others	8	10	x			
<b>Non-nuclear Radioactive Wastes</b>						
Medical / research wastes	9	28	x			
Industrial wastes	21	51	x			
Others	17	20	x			
<b>Consumer Products</b>						
Smoke detectors	8	11	x			
Radioluminescent products	na	na				
Lighting products	na	na				
Others (specify)						

Reporting Country: Latvia

Reporting Year: 2001

Radioactive Material	Annual transport volume		Predominant transport mode			
	N <sup>o</sup> Shipments per Year	N <sup>o</sup> Packages per Year	Road	Rail	Air	Sea
<b>Fuel Cycle Material:</b>						
Irradiated fuel assemblies, fuel pins (UO <sub>2</sub> , MOX)	nr					
Non-Irradiated fuel assemblies, fuel pins (UO <sub>2</sub> , MOX)	nr					
Uranium/thorium ore	nr					
Pre-fuel material (UOC, U <sub>3</sub> O <sub>8</sub> , UO <sub>2</sub> , MOX, pellets etc.)	nr					
Uranium Hexafluoride (UF <sub>6</sub> )	nr					
Vitrified radioactive waste	nr					
Low-/intermediate-level radioactive waste (LLW/ILW)	nr					
Unloaded (empty) flasks	nr					
Others (samples, components, monitoring equipment etc.)	nr					
<b>Radioisotope Supply and Distribution:</b>						
Type B packages	2	2	x			
Type A packages	101	133	x			
Excepted packages	nr					
Others – sources and sources in containers A-172	nr					
<b>Radiation Sources:</b>						
Radiographic radiation sources	1	1				
Nuclear density/portable gauging devices	6	6	x			
Others – from Salaspils RR to disposal site	39	39				
<b>Non-nuclear Radioactive Wastes</b>						
Medical / research wastes	4	6	x			
Industrial wastes	20	65	x			
Others	15	15	x			
<b>Consumer Products</b>						
Smoke detectors	4	4	x			
Radioluminescent products	nr					
Lighting products	nr					
Others (specify)	na					



Reporting Country: Lithuania

Reporting Year: 2001

Radioactive Material	Annual transport volume		Predominant transport mode			
	N <sup>o</sup> Shipments per Year	N <sup>o</sup> Packages per Year	Road	Rail	Air	Sea
<b>Fuel Cycle Material:</b>						
Irradiated fuel assemblies, fuel pins (UO <sub>2</sub> , MOX)	-	-				
Non-Irradiated fuel assemblies, fuel pins (UO <sub>2</sub> , MOX)	3	na		x		
Uranium/thorium ore	-	-				
Pre-fuel material (UOC, U <sub>3</sub> O <sub>8</sub> , UO <sub>2</sub> , MOX, pellets etc.)	-	-				
Uranium Hexafluoride (UF <sub>6</sub> )	-	-				
Vitrified radioactive waste	-	-				
Low-/intermediate-level radioactive waste (LLW/ILW)	-	-				
Unloaded (empty) flasks	6	9	x			
Others (samples, components, monitoring equipment etc.)	5	5			x	
<b>Radioisotope Supply and Distribution:</b>						
Type B packages	-	-				
Type A packages	117	na	x			
Excepted packages	112	na	x			
Others	-	-				
<b>Radiation Sources:</b>						
Radiographic radiation sources	10	na	x			
Nuclear density/portable gauging devices	1	1	x			
Others	6	na	x			
<b>Non-nuclear Radioactive Wastes</b>						
Medical / research wastes	11	na	x			
Industrial wastes	35	na	x			
Others	-	-				
<b>Consumer Products</b>						
Smoke detectors	-	-				
Radioluminescent products	-	-				
Lighting products	-	-				
Others (specify)						

Reporting Country: Malta

Reporting Year:

2001

Radioactive Material	Annual transport volume		Predominant transport mode			
	N <sup>o</sup> Shipments per Year	N <sup>o</sup> Packages per Year	Road	Rail	Air	Sea
<b>Fuel Cycle Material:</b>						
Irradiated fuel assemblies, fuel pins (UO <sub>2</sub> , MOX)						
Non-Irradiated fuel assemblies, fuel pins (UO <sub>2</sub> , MOX)						
Uranium/thorium ore						
Pre-fuel material (UOC, U <sub>3</sub> O <sub>8</sub> , UO <sub>2</sub> , MOX, pellets etc.)						
Uranium Hexafluoride (UF <sub>6</sub> )						
Vitrified radioactive waste						
Low-/intermediate-level radioactive waste (LLW/ILW)						
Unloaded (empty) flasks						
Others (samples, components, monitoring equipment etc.)						
<b>Radioisotope Supply and Distribution:</b>						
Type B packages	1	1				x
Type A packages	115	155	x			
Excepted packages	8	8	x			
Others						
<b>Radiation Sources:</b>						
Radiographic radiation sources	20	4	x			
Nuclear density/portable gauging devices						
Others						
<b>Non-nuclear Radioactive Wastes</b>						
Medical / research wastes	1	3				x
Industrial wastes						
Others						
<b>Consumer Products</b>						
Smoke detectors						
Radioluminescent products						
Lighting products						
Others (specify)						

Reporting Country: Poland

Reporting Year: 2001

Radioactive Material	Annual transport volume		Predominant transport mode			
	N <sup>o</sup> Shipments per Year	N <sup>o</sup> Packages per Year	Road	Rail	Air	Sea
<b>Fuel Cycle Material:</b>						
Irradiated fuel assemblies, fuel pins (UO <sub>2</sub> , MOX)	nr					
Non-Irradiated fuel assemblies, fuel pins (UO <sub>2</sub> , MOX)	2	26		x		
Uranium/thorium ore	nr					
Pre-fuel material (UOC, U <sub>3</sub> O <sub>8</sub> , UO <sub>2</sub> , MOX, pellets etc.)	nr					
Uranium Hexafluoride (UF <sub>6</sub> )	nr					
Vitrified radioactive waste	nr					
Low-/intermediate-level radioactive waste (LLW/ILW)	nr					
Unloaded (empty) flasks	nr					
Others (samples, components, monitoring equipment etc.)	nr					
<b>Radioisotope Supply and Distribution:</b>						
Type B packages	380	420	x			
Type A packages	5500	12000	x			
Excepted packages	700	2600	x			
Others						
<b>Radiation Sources:</b>						
Radiographic radiation sources	2800	8500	x			
Nuclear density/portable gauging devices	650	1500	x			
Others						
<b>Non-nuclear Radioactive Wastes</b>						
Medical / research wastes	20/25	110/260	x			
Industrial wastes	230	1200	x			
Others						
<b>Consumer Products</b>	na					
Smoke detectors						
Radioluminescent products						
Lighting products						
Others (specify)						

Reporting Country: Romania

Reporting Year: 2001

Radioactive Material	Annual transport volume		Predominant transport mode				
	N <sup>o</sup> Shipments per Year	N <sup>o</sup> Packages per Year	Road	Rail	Air	Sea	River
<b>Fuel Cycle Material:</b>							
Irradiated fuel assemblies, fuel pins (UO <sub>2</sub> , MOX)							
Non-Irradiated fuel assemblies, fuel pins (UO <sub>2</sub> , MOX)	8+(3) <sup>4</sup>	160+(100)	x				(x)
Uranium/thorium ore	95	1447		x			
Pre-fuel material (UOC, U <sub>3</sub> O <sub>8</sub> , UO <sub>2</sub> , MOX, pellets etc.)	9	513	x				
Uranium Hexafluoride (UF <sub>6</sub> )							
Vitrified radioactive waste							
Low-/intermediate-level radioactive waste (LLW/ILW)							
Unloaded (empty) flasks							
Others (samples, components, monitoring equipment etc.)	1	21	x				
<b>Radioisotope Supply and Distribution:</b>							
Type B packages	3	4	x		x		
Type A packages	8	9	x		x		
Excepted packages	6	6	x		x		
Others	8	8	x				
<b>Radiation Sources:</b>							
Radiographic radiation sources	650	880	x				
Nuclear density/portable gauging devices	30	36	x				
Others							
<b>Non-nuclear Radioactive Wastes</b>							
Medical / research wastes							
Industrial wastes							
Others	41	314	x				
<b>Consumer Products</b>							
Smoke detectors							
Radioluminescent products							
Lighting products							
Others (specify)							

<sup>4</sup> Bulgarian shipment in transit

Reporting Country: Slovak Republic

Reporting Year: 2001

Radioactive Material	Annual transport volume		Predominant transport mode			
	N° Shipments per Year	N° Packages per Year	Road	Rail	Air	Sea
<b>Fuel Cycle Material:</b>						
Irradiated fuel assemblies, fuel pins (UO2, MOX)	-	-				
Non-Irradiated fuel assemblies, fuel pins (UO2, MOX)	20	145		x		
Uranium/thorium ore	-	-				
Pre-fuel material (UOC, U3O8, UO2, MOX, pellets etc.)	47	89		x		
Uranium Hexafluoride (UF6)	-	-				
Vitrified radioactive waste	-	-				
Low-/intermediate-level radioactive waste (LLW/ILW)	418	3322	x			
Unloaded (empty) flasks						
Others (samples, components, monitoring equipment etc.)						
<b>Radioisotope Supply and Distribution:</b>						
Type B packages						
Type A packages						
Excepted packages						
Others						
<b>Radiation Sources:</b>						
Radiographic radiation sources						
Nuclear density/portable gauging devices						
Others						
<b>Non-nuclear Radioactive Wastes</b>						
Medical / research wastes						
Industrial wastes						
Others						
<b>Consumer Products</b>						
Smoke detectors	-	-	x			
Radioluminescent products	-	-				
Lighting products	-	-				
Others (specify)						

Reporting Country: Turkey

Reporting Year: 2001

Radioactive Material	Annual transport volume		Predominant transport mode			
	N° Shipments per Year	N° Packages per Year	Road	Rail	Air	Sea
<b>Fuel Cycle Material:</b>						
Irradiated fuel assemblies, fuel pins (UO2, MOX)	nr	nr				
Non-Irradiated fuel assemblies, fuel pins (UO2, MOX)	nr	nr				
Uranium/thorium ore	nr	nr				
Pre-fuel material (UOC, U3O8, UO2, MOX, pellets etc.)	nr	nr				
Uranium Hexafluoride (UF6)	nr	nr				
Vitrified radioactive waste	nr	nr				
Low-/intermediate-level radioactive waste (LLW/ILW)	nr	nr				
Unloaded (empty) flasks	nr	nr				
Others (samples, components, monitoring equipment etc.)	nr	nr				
<b>Radioisotope Supply and Distribution:</b>						
Type B packages	10	50	x			
Type A packages	400	6000	x			
Excepted packages	10	300	x			
Others	na	na				
<b>Radiation Sources:</b>						
Radiographic radiation sources	300	30	x			
Nuclear density/portable gauging devices	20	20	x			
Others	62	62	x			
<b>Non-nuclear Radioactive Wastes</b>						
Medical / research wastes	17	17	x			
Industrial wastes	2	2	x			
Others	29	29	x			
<b>Consumer Products</b>						
Smoke detectors	na	na				
Radioluminescent products	na	na				
Lighting products	18	18	x			
Others (specify)	na	na				

Reporting Country: Austria  
 Reporting Year: 2001

Transport Operations	Annual effective Dose (mSv/y)				Remarks
	Transport Workers		Public (Critical)		
	Avg.	min/max	Avg.	min/max	
Nuclear Fuel Cycle					
Road					
Rail					
Air					
Sea					
Radioisotope Supply and Distribution					
Road					
Rail					
Air					
Radiation Sources					
Radiography					
Nuclear density/gauging devices					
Other types					
Non-nuclear Wastes					
Medical/research/industry					
Consumer Products					
Road/Rail/Air/Sea					

Reporting Country: Belgium  
 Reporting Year: 2001

Transport Operations	Annual effective Dose				Remarks
	Transport Workers		Public (Critical)		
	Avg.	min/max	Avg.	min/max	
Nuclear Fuel Cycle					
Road	1.5	0.1/ 3.5			Some workers also partially active in radioisotope supply.
Rail	na	na	na	na	Average from nuclear fuel cycle probably not more than 1 mSv/y.
Air	na	na	na	na	
Sea	na	na	na	na	
Radioisotope Supply and Distribution					
Road	3.4	0.1/ 11.5			Handling on airport only- no crew figures available
Rail					
Air	1.4	0.1/ 7.9			
Radiation Sources					No transport-only figures available
Radiography					
Nuclear density/gauging devices					
Other types					
Non-nuclear Wastes					Included in the figures given for either radioisotope supply or nuclear fuel cycle
Medical/research/industry					
Consumer Products					
Road/Rail/Air/Sea	na	na			

Reporting Country: Cyprus  
 Reporting Year: 2001

Transport Operations	Annual effective Dose (mSv/y)				Remarks
	Transport Workers		Public (Critical)		
	Avg.	min/max	Avg.	min/max	
Nuclear Fuel Cycle					
Road					
Rail					
Air					
Sea					
Radioisotope Supply and Distribution					
Road					
Rail					
Air					
Radiation Sources					
Radiography					
Nuclear density/gauging devices					
Other types					
Non-nuclear Wastes					
Medical/research/industry					
Consumer Products					
Road/Rail/Air/Sea					

Reporting Country: Czech Republic  
 Reporting Year: 2001

Transport Operations	Annual effective Dose (mSv/y)				Remarks
	Transport Workers		Public (Critical)		
	Avg.	min/max	Avg.	min/max	
Nuclear Fuel Cycle					
Road	0.016	0/0.06	na	na	
Rail	0.015	0.01/0.06	na	na	
Air	nr	nr	nr	nr	
Sea	nr	nr	nr	nr	
Radioisotope Supply and Distribution					
Road	na	na	na	na	
Rail	na	na	na	na	
Air	na	na	na	na	
Radiation Sources					
Radiography	na	na	na	na	
Nuclear density/gauging devices	na	na	na	na	
Other types					
Non-nuclear Wastes					
Medical/research/industry	na	na	na	na	
Consumer Products					
Road/Rail/Air/Sea	na	na	na	na	



Reporting Country: Denmark  
 Reporting Year: 2001

Transport Operations	Annual effective Dose (mSv/y)				Remarks
	Transport Workers		Public (Critical)		
	Avg.	min/max	Avg.	min/max	
Nuclear Fuel Cycle					
Road	na	na	na	na	
Rail	nr	nr	nr	nr	
Air	nr	nr	nr	nr	
Sea	nr	nr	nr	nr	
Radioisotope Supply and Distribution					
Road	0.2	0.1/7.8	na	na	
Rail	na	na	na	na	
Air	na	na	na	na	
Radiation Sources					
Radiography	na	na	na	na	
Nuclear density/gauging devices	na	na	na	na	
Other types					
Non-nuclear Wastes					
Medical/research/industry	< 70 uSv/y		na	na	
Consumer Products					
Road/Rail/Air/Sea	na	na	na	na	

Reporting Country: Finland  
 Reporting Year: 2001

Transport Operations	Annual effective Dose (mSv/y)				Remarks
	Transport Workers		Public (Critical)		
	Avg.	min/max	Avg.	min/max	
Nuclear Fuel Cycle					
Road					Data dose not exist. Doses estimated to be less than 1mSv/y in all cases.
Rail					
Air					
Sea					
Radioisotope Supply and Distribution					
Road					
Rail					
Air					
Radiation Sources					
Radiography					
Nuclear density/gauging devices					
Other types					
Non-nuclear Wastes					
Medical/research/industry					
Consumer Products					
Road/Rail/Air/Sea					

Reporting Country: Greece  
Reporting Year: 2001

Transport Operations	Annual effective Dose (mSv/y)				Remarks
	Transport Workers		Public (Critical)		
	Avg.	min/max	Avg.	min/max	
Nuclear Fuel Cycle					
Road					
Rail					
Air					
Sea					
Radioisotope Supply and Distribution					
Road	2.5	0.1/5.2	*		*The amount and frequency of RAM transport dose not necessitate public monitoring
Rail					
Air					
Radiation Sources					
Radiography	**				** The use and transport of
Nuclear density/gauging devices	**				These sources is done by the
Other types					same person.
Non-nuclear Wastes					
Medical/research/industry					
Consumer Products					
Road/Rail/Air/Sea					

Reporting Country: Hungary  
Reporting Year: 2001

Transport Operations	Annual effective Dose (mSv/y)				Remarks
	Transport Workers		Public (Critical)		
	Avg.	min/max	Avg.	min/max	
Nuclear Fuel Cycle					
Road	nr	nr	nr	nr	
Rail	nr	nr	nr	nr	
Air	nr	nr	nr	nr	
Sea	nr	nr	nr	nr	
Radioisotope Supply and Distribution					
Road	3.3	0.92/4.53	<0.01		Max: 2 flights/week, 350h/y Avg: 2 flights/y, 6h/y @ 3m
Rail			<0.01		
Air			0.05	10.7	
Radiation Sources					
Radiography	0.05	0/10.29			
Nuclear density/gauging devices					
Other types					
Non-nuclear Wastes					
Medical/research/industry	0.083	0/10.29			
Consumer Products					
Road/Rail/Air/Sea					

Reporting Country: Ireland  
 Reporting Year: 2001

Transport Operations	Annual effective Dose (mSv/y)				Remarks
	Transport Workers		Public (Critical)		
	Avg.	min/max	Avg.	min/max	
Nuclear Fuel Cycle					
Road	nr	nr	nr	nr	
Rail	nr	nr	nr	nr	
Air	nr	nr	nr	nr	
Sea	nr	nr	nr	nr	
Radioisotope Supply and Distribution					
Road	-	0-0.3	na	na	
Rail	na	na	na	na	
Air	na	na	na	na	
Radiation Sources					
Radiography	na	na	na	na	
Nuclear density/gauging devices	na	na	na	na	
Other types					
Non-nuclear Wastes					
Medical/research/industry	nr	nr	nr	nr	
Consumer Products					
Road/Rail/Air/Sea	na	na	na	na	

Reporting Country: Latvia  
 Reporting Year: 2001

Transport Operations	Annual effective Dose (mSv/y)				Remarks
	Transport Workers		Public (Critical)		
	Avg.	min/max	Avg.	min/max	
Nuclear Fuel Cycle					
Road	nr	nr	nr	nr	
Rail	nr	nr	nr	nr	
Air	nr	nr	nr	nr	
Sea	nr	nr	nr	nr	
Radioisotope Supply and Distribution					
Road	0.8	0.3/1	na	na	
Rail	nr	nr	na	na	
Air	na	na	na	na	
Radiation Sources					
Radiography	na	na	na	na	
Nuclear density/gauging devices	na	na	na	na	
Other types	0.8	0.3/0.9			
Non-nuclear Wastes					
Medical/research/industry	0.5	0.3/0.7	na	na	
Consumer Products					
Road/Rail/Air/Sea	0.1	0.01/0.2	na	na	

Reporting Country: Lithuania  
 Reporting Year: 2001

Transport Operations	Annual effective Dose (mSv/y)				Remarks
	Transport Workers		Public (Critical)		
	Avg.	min/max	Avg.	min/max	
Nuclear Fuel Cycle					individual exposure doses for workers are below 6 mSv/y
Road	nr	nr	nr	nr	
Rail	nr	nr	nr	nr	
Air	nr	nr	nr	nr	
Sea	nr	nr	nr	nr	
Radioisotope Supply and Distribution					The same worker is involved in all activities, therefore doses are not separated
Road	1.7	0.78/3.57	<10uSv/y		
Rail					
Air					
Radiation Sources					
Radiography					
Nuclear density/gauging devices					
Other types					
Non-nuclear Wastes					
Medical/research/industry					
Consumer Products					
Road/Rail/Air/Sea					

Reporting Country: Luxemburg  
 Reporting Year: 2001

Transport Operations	Annual effective Dose (mSv/y)				Remarks
	Transport Workers		Public (Critical)		
	Avg.	min/max	Avg.	min/max	
Nuclear Fuel Cycle					
Road					
Rail					
Air					
Sea					
Radioisotope Supply and Distribution					
Road					
Rail					
Air					
Radiation Sources					
Radiography					
Nuclear density/gauging devices	<0.1	<0.1	<0.1	<0.1	
Other types					
Non-nuclear Wastes					
Medical/research/industry					
Consumer Products					
Road/Rail/Air/Sea					

Reporting Country: Malta  
 Reporting Year: 2001

Transport Operations	Annual effective Dose (mSv/y)				Remarks
	Transport Workers		Public (Critical)		
	Avg.	min/max	Avg.	min/max	
Nuclear Fuel Cycle					
Road					
Rail					
Air					
Sea					
Radioisotope Supply and Distribution					
Road					
Rail					
Air					
Radiation Sources					
Radiography					
Nuclear density/gauging devices					
Other types					
Non-nuclear Wastes					
Medical/research/industry			12uSv/h	80uSv/h	Co-60 medical use
Consumer Products					
Road/Rail/Air/Sea					

Reporting Country: Poland  
 Reporting Year: 2001

Transport Operations	Annual effective Dose (mSv/y)				Remarks
	Transport Workers		Public (Critical)		
	Avg.	min/max	Avg.	min/max	
Nuclear Fuel Cycle					
Road					
Rail					
Air					
Sea					
Radioisotope Supply and Distribution					
Road	2	0.8/11	na	na	
Rail					
Air					
Radiation Sources					
Radiography					
Nuclear density/gauging devices					
Other types					
Non-nuclear Wastes					
Medical/research/industry					
Consumer Products					
Road/Rail/Air/Sea					

Reporting Country: Romania  
 Reporting Year: 2001

Transport Operations	Annual effective Dose (mSv/y)				Remarks
	Transport Workers		Public (Critical)		
	Avg.	min/max	Avg.	min/max	
Nuclear Fuel Cycle					
Road	9.1	0.8/11.49	<0.07		
Rail	5.79	5.62/5.79	<0.07		
Air	<1		<0.1		
Sea					
Radioisotope Supply and Distribution					
Road	<1		~ 0.1		
Rail					
Air	<1		~ 0.1		
Radiation Sources					
Radiography	<1		~ 0.1		
Nuclear density/gauging devices	<1		~ 0.1		
Other types					
Non-nuclear Wastes					
Medical/research/industry	<1		~ 0.1		
Consumer Products					
Road/Rail/Air/Sea					

Reporting Country: Slovakia  
 Reporting Year: 2001

Transport Operations	Annual effective Dose (mSv/y)				Remarks
	Transport Workers		Public (Critical)		
	Avg.	min/max	Avg.	min/max	
Nuclear Fuel Cycle					
Road					
Rail					
Air					
Sea					
Radioisotope Supply and Distribution					
Road					
Rail					
Air					
Radiation Sources					
Radiography					
Nuclear density/gauging devices					
Other types					
Non-nuclear Wastes					
Medical/research/industry					
Consumer Products					
Road/Rail/Air/Sea					

Reporting Country: Spain  
 Reporting Year: 2001

Transport Operations	Annual effective Dose (mSv/y)				Remarks
	Transport Workers		Public (Critical group)		
	Avg.	min/max	Avg.	min/max	
Nuclear Fuel Cycle					
Road	1.11	0.14/2.25	na	na	
Rail	nr	nr	nr	nr	
Air	nr	nr	nr	nr	
Sea	na	na	na	na	
Radioisotope Supply and Distribution					
Road	3.84	0.05/14.83	na	na	
Rail	nr	nr	nr	nr	
Air	na	na	na	na	
Radiation Sources					
Radiography	na	na	na	na	
Nuclear density/gauging devices	na	na	na	na	
Other types					
Non-nuclear Wastes					
Medical/research/industry	0.5	0.5/0.5	na	na	
Consumer Products					
Road/Rail/Air/Sea	na	na	na	na	

Reporting Country: Sweden  
 Reporting Year: 2001

Transport Operations	Annual effective Dose (mSv/y)				Remarks
	Transport Workers		Public (Critical group)		
	Avg.	min/max	Avg.	min/max	
Nuclear Fuel Cycle					
Road	na	na			
Rail	na	na			
Air	na	na			
Sea	<1	<1			
Radioisotope Supply and Distribution					
Road					
Rail					
Air					
Radiation Sources					
Radiography					
Nuclear density/gauging devices					
Other types					
Non-nuclear Wastes					
Medical/research/industry					
Consumer Products					
Road/Rail/Air/Sea					

Reporting Country: Turkey  
 Reporting Year: 2001

Transport Operations	Annual effective Dose (mSv/y)				Remarks
	Transport Workers		Public (Critical group)		
	Avg.	min/max	Avg.	min/max	
Nuclear Fuel Cycle					
Road	nr	nr	nr	nr	
Rail	nr	nr	nr	nr	
Air	nr	nr	nr	nr	
Sea	nr	nr	nr	nr	
Radioisotope Supply and Distribution					
Road	<1	na	na	na	no critical group defined
Rail	na	na	na	na	
Air	na	na	na	na	
Radiation Sources					
Radiography	<1	na	na	na	
Nuclear density/gauging devices	<1	na	na	na	
Other types					
Non-nuclear Wastes					
Medical/research/industry	<1	na	na	na	
Consumer Products					
Road/Rail/Air/Sea	<1	na	na	na	

Reporting Country: Estonia  
 Reporting Year: 2001

Transport Operations	Annual effective Dose (mSv/y)				Remarks
	Transport Workers		Public (Critical group)		
	Avg.	min/max	Avg.	min/max	
Nuclear Fuel Cycle					
Road	nr	nr	nr	nr	
Rail	nr	nr	nr	nr	
Air	nr	nr	nr	nr	
Sea	nr	nr	nr	nr	
Radioisotope Supply and Distribution					
Road	na	na	na	na	
Rail	na	na	na	na	
Air	na	na	na	na	
Radiation Sources					
Radiography	na	na	na	na	
Nuclear density/gauging devices	na	na	na	na	
Other types					
Non-nuclear Wastes					
Medical/research/industry	na	na	na	na	
Consumer Products					
Road/Rail/Air/Sea	na	na	na	na	



## Annex 1

# Statistics on the transport of radioactive materials in the UK and statistical analysis

## UK Contribution

Work performed under  
EC Contract Reference No. TMR 2001/300 (DG TREN):  
Statistics on the Transport of Radioactive Material and Statistical Analyses

Produced and Compiled by:  
S. Warner Jones  
NRPB, Chilton, Didcot, Oxfordshire, OX11 0RQ  
December 2002

1. Introduction
2. Background into radioactive materials transport in the UK
3. Methods of data collection
4. Transport Statistics
  - 4.1 Nuclear Industry
  - 4.2 Medical and industrial uses of isotopes
  - 4.3 Radiation sources
  - 4.4 Consumer products
5. Worker dose statistics
  - 5.1 Nuclear industry
  - 5.2 Medical and industrial uses of isotopes
  - 5.3 Radiation sources
  - 5.4 Consumer products
6. Public dose statistics
7. Discussion and conclusions
8. Acknowledgements
9. References

## 1. Introduction

This report contains the UK data collected and analysed as part of the EC contract “Statistics on the transport of radioactive material and statistical analyses.” The data are the most recent available, and obtained directly from operators. Some values are estimates and based on sample data.

## 2. Background into radioactive materials transport in the UK

As in all countries, the ability to use radioactive materials is dependent on the ability to transport them.

The UK has 14 commercial nuclear power stations in operation, each of these requiring the regular transport of radioactive materials to keep operating. This transport includes the delivery of new fuel, the removal of spent fuel and ILW and LLW. Other areas of the nuclear industry with a high presence in the UK are new fuel production, enrichment of UF<sub>6</sub> and reprocessing of spent fuels from other countries.

Medical use of radioisotopes is a very important diagnostic tool and requires the movement of radioactive materials to hospitals throughout the country. The UK also houses one of the worlds biggest suppliers of isotopes for medical and industrial use shipping radioactive materials by air to all continents. Most of this transport is carried out by air using cargo carriers with hubs in Northern Europe.

Other isotopes that rely on transport for their use are nuclear density gauges (NDG) used to ensure that road surface have been laid correctly. Historically all county council highways laboratories possessed at least one NDG; changes in policy have meant that most of the work carried out by these laboratories is now contracted out to commercial companies.

Smoke detectors are the main consumer product produced and shipped in the UK. The manufacture of smoke detectors involves the shipment of americium foils as sheets, then as part of an ionisation chamber unit and inside the housing as a complete product. These shipments are between Asia and England where different stages of the manufacture are carried out. The final products are then distributed throughout the UK for sale in stores.

## 3. Methods of data collection

The main method of data collection was through the use of the questionnaire developed within the EC project. This questionnaire was used to introduce the subject and to give the user an idea of the information that is required. Information was sought from the main UK producers and suppliers of medical isotopes and industrial sources; BNFL for raw materials, UF<sub>6</sub>, new fuel, and irradiated fuel flask movements, and other companies in the nuclear industry for UF<sub>6</sub> and fuel flask movements.

## 4. Transport Statistics

### 4.1 Nuclear Industry

#### 4.1.1 Import and movement of raw materials

Imports of uranium ore into the UK are arranged by the customer for the final product. In 2001, 4,512 tonnes of Uranium Ore Concentrate (UOC) were imported into the UK in 370 shipments containing a total of 13,300 drums of material (Collier, 2002).

#### 4.1.2 Import export and UK movement of pre fuel materials

Shipments of pre-fuel enriched  $UO_2$  to Europe are made by road and sea/road. In 2001, 208 tonnes of  $UO_2$  were shipped in 36 shipments containing a total of 970 drums (Collier, 2002).

UF6 is enriched in the UK for the production of enriched fuel. This results in transport of three product streams: enriched UF6 for the manufacture of fuel (product<sup>5</sup>), depleted UF6 (tails), and natural UF6 (feed). Some depleted UF6 is shipped abroad where it is re-enriched to natural levels before returning to the UK for further enrichment (Ingman, 2002). The two companies handling UF6 in the UK are the enrichment company and the fuel manufacturers.

The enrichment company ships the product in cylinders (with overpacks) to the UK manufacturing site (circa 25% of the material) and abroad via Liverpool Docks and Felixstowe. The majority of the material for export is shipped to the USA for fuel manufacture; the remainder is shipped to Europe and the Far East via Felixstowe. In total, there were 70 consignments of enriched UF6 in 2001; this required 80 road movements (therefore 80 shipments) of 285 cylinders (Ingman, 2002). Up to 4 Type AF fissile containers can be transported on one vehicle.

Natural UF6 comes from the UK manufacturers by road or from abroad via Liverpool Docks, where it is shipped by road to the site. There were 57 such consignments in 2001 consisting of 584 cylinders (Ingman, 2002, Collier, 2002). Due to the size and weight of these cylinders, only one cylinder can be transported on a lorry. These consignments therefore resulted in 584 shipments by road.

---

<sup>5</sup> Enriched UF6 is known as the product, Natural UF6 is known as feed, and depleted UF6 is known as tails.



There are 4 consignments of tails each year, these are transported, in the same cylinders as feed, by charter vessel which leaves from the port at Ellesmere Port. In 2001, there were 592 cylinders transported resulting in 592 vehicle movements (Ingman, 2002).

3,732 tonnes of natural UF<sub>6</sub> was exported from the UK manufacturing site in 2001 (Collier, 2002), these movements were either to the UK enrichment company or Europe by road/sea/road. There were 226 vehicle movements (shipments) in 2001 of 226 cylinders destined for Europe and a further 212 shipments of cylinders within the UK. These shipments form part of the 584 incoming shipments at the enrichment site (Ingman, 2002).

Enriched UF<sub>6</sub> is received by the fuel manufacturers from Europe and the UK enrichment company. The fuel manufacturers received 417 tonnes of the product consisting of 58 shipments of 174 cylinders from Europe and a further 35 shipments of 71 cylinders from the UK enrichment site (Collier, 2002).



#### 4.1.3 New fuel elements

In the UK new fuel consists of either natural uranium fuel rods for use in Magnox reactors or fuel pellets in finished enriched UO<sub>2</sub> fuel assemblies for AGR and PWR reactors. Magnox fuel rods are transported as unpackaged LSA-1 material. There were 76 shipments of this material in 2001 with a total mass of 570 tonnes.

Fuel assemblies are transported packaged: in 2001 there were 648 packages shipped over 94 shipments with a total mass of 227 tonnes (Collier, 2002). These materials are shipped by road.

#### 4.1.4 Fuel flask movements – trends

Information on fuel flask movements from UK Power Stations to the UK reprocessing site has been provided by the two UK nuclear energy companies. Trend data has also been provided by these companies for each of their power stations for a 5-year period to 2001 (Lee, 2002, Bennett, 2002). Information has also been provided on the number of discharged flask movements for each year. The one PWR reactor in the UK has not yet required any spent fuel shipments.

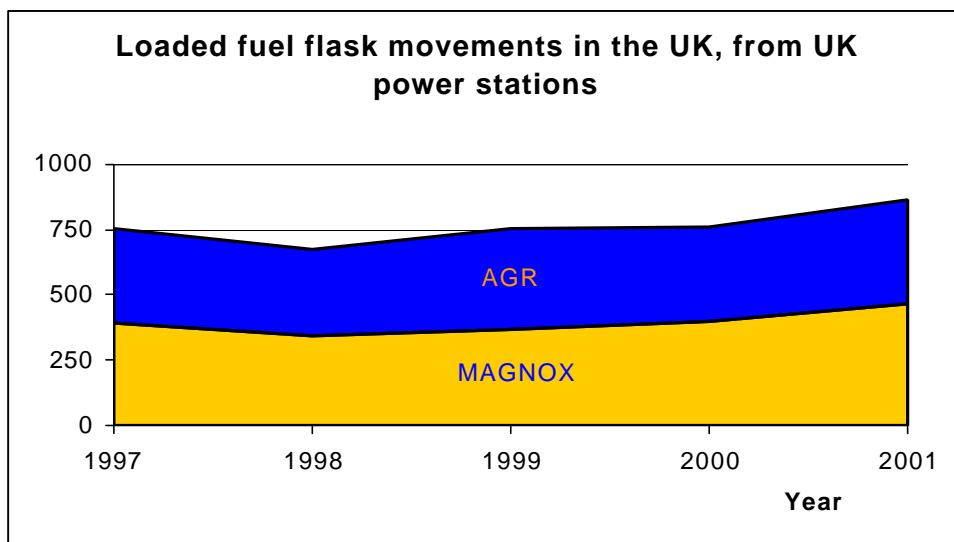

The majority of the power stations transfer a similar number of flasks per year. Large variations in flask numbers for individual years can usually be accounted for by operational requirements. For example, one station, (MAGNOX 4 in the figure below) shut down in 1999, and this has resulted in a decrease in flask movements in the latter years. Another (MAGNOX 2) was defuelled in 2001 due to a fault with the reactor, resulting in a four-fold increase in the number of flask shipments that year.

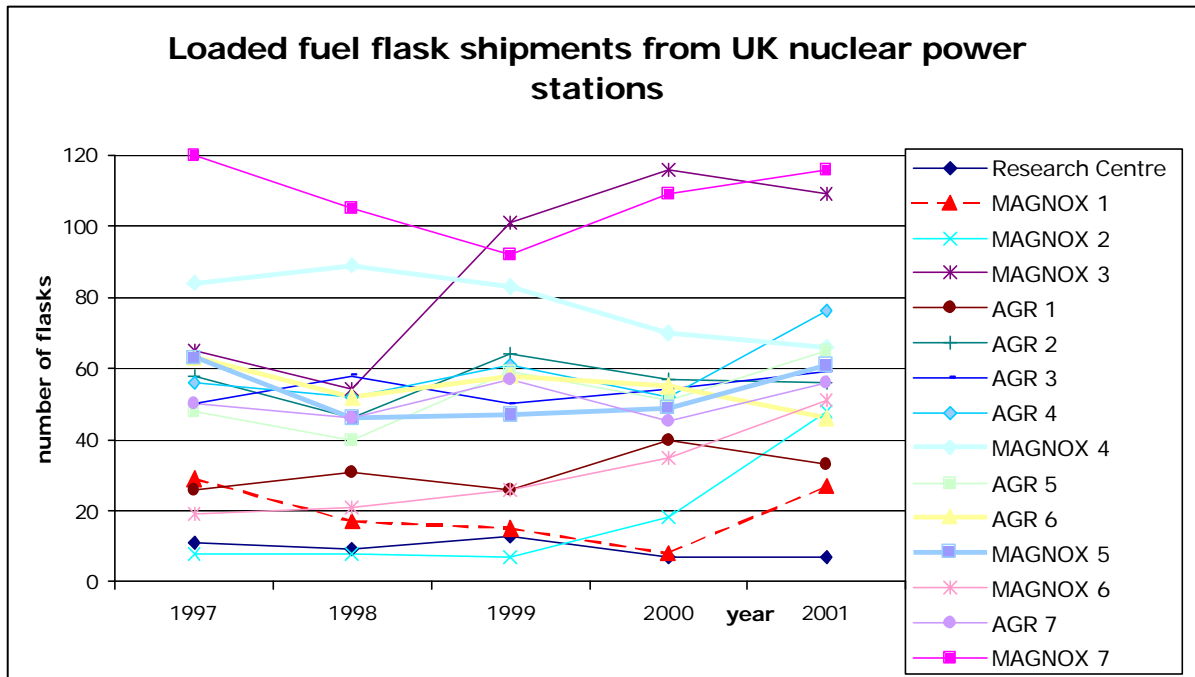

#### 4.2 Medical and industrial uses of isotopes

Information on medical and industrial isotopes was provided by the two main UK producers/suppliers (Carrington, 2002, Talbot, 2003). An exact figure for the number of packages was available, but this could not be further broken down by package type. It was known that around 1/3 of all packages for the medical and industrial sector contain technetium generators ( $^{99}\text{Mo}$  sources), the other two thirds are split approximately evenly between other Type A packages (usually with a TI of 0.0) and Excepted packages. These packages are transported by road either to airports for export or to UK distribution hubs for supply to hospitals around the UK.

From July to October 2002 there were 65,902 packages dispatched from the main UK medical supplier, averaged out over the entire year, this equates to around 200,000 Excepted and Type A packages. The other main UK supplier transported 107 Type A packages for destinations around the world (Talbot, 2003).

#### 4.3 Radiation sources

Information on the number of nuclear density gauges and industrial radiography sources was requested by the users of these materials (Airey, 2002). Figures were obtained for around 5500 return movements (11150 movements in total) of 85 nuclear density gauges. As information on all gauges was not available, this figure was extrapolated to 100 gauges carrying out a total of 6000 return trips (12000 individual movements). Historically these gauges were owned by each of the county Council highways laboratories, but due to privatisation of these facilities in most counties, the majority of the work now falls to external contractors. There were two groups of users; light users which were mainly the few remaining county council highways laboratories and smaller contractor firms (usually those that replaced the county council sites), and the larger contractor firms. The smaller companies moved gauges

approximately 100 times in 2001, whereas the larger companies who tended to have more gauges located at different sites transported gauges about 1500 times in 2001.

Information on industrial radiography sources was provided by one supplier who transported 231 packages in 230 shipments in 2001, (Talbot, 2003) one other supplier dispatches around 60 sources per year.

#### 4.4 Consumer products

The most important consumer product in the UK is americium smoke detectors. These products are manufactured in the UK and are shipped worldwide. Around 1.5 million smoke detectors are sold for use in the UK each year (Gelder, 2001). They are only classed as radioactive material for transport purposes when transported in bulk. They are excluded from the transport regulations when sold individually to the consumer. It has been estimated that around 1050 packages each containing 1440 assembled smoke detectors are transported each year in the UK. Other consumer products identified in the UK are gemstones, where there were 42 shipments of 177 packages in 2001, and contaminated laundry and other analytical materials that were shipped individually in 155 shipments (Talbot, 2003).







Table 1 Transport Volumes<sup>6</sup> in the UK - 2001

Radioactive Material	Annual transport volume		Predominant transport mode			
	N <sup>o</sup> Shipments per Year	N <sup>o</sup> Packages per Year	Road	Rail	Air	Sea
<b>Fuel Cycle Material:</b>						
Irradiated fuel assemblies, fuel pins (UO <sub>2</sub> , MOX)	na	863	x	x		
Non-Irradiated fuel assemblies, fuel pins (UO <sub>2</sub> , MOX)	170	750	x	x		
Uranium/thorium ore	370	13300	x	x		
Pre-fuel material (UOC, U <sub>3</sub> O <sub>8</sub> , UO <sub>2</sub> , MOX, pellets etc.)	36	970	x	x		x
Uranium Hexafluoride (UF <sub>6</sub> )	662	2144	x	x		x
Vitrified radioactive waste	na	na				
Low-/intermediate-level radioactive waste (LLW/ILW)	na	na	x			
Unloaded (empty) flasks	na	936	x	x		
Others (samples, components, monitoring equipment etc.)	na	na				
<b>Radioisotope Supply and Distribution:</b>						
Type B packages	na	na	x		x	x
Type A packages	na	132000	x		x	x
Excepted packages	na	66000	x		x	x
Others						
<b>Radiation Sources:</b>						
Radiographic radiation sources	1000	1000	x			
Nuclear density/portable gauging devices	12000	(100 <sup>7</sup> ) 12000	x			
Others						
<b>Non-nuclear Radioactive Wastes</b>						
Medical / research wastes	na	na				
Industrial wastes	na	na				
Others - Site Decommissioning	28	28				
<b>Consumer Products</b>						
Smoke detectors	200	1050	x			x
Radioluminescent products	na	na				
Lighting products	na	na				
Gem Stones	42	177			x	
Laundry/Variou analytical	155	155	x			

<sup>6</sup> The nuclear fuel cycle data, waste data and the latter consumer product data are of actual volumes. Other data are best estimates based on actual figures for a 4 month period.

<sup>7</sup> There are approximately 100 nuclear density gauges in operation in the UK, carrying out 4000 return journeys.

## 5. Worker dose statistics

Information on worker doses came from three main sources; actual dose records from individual companies; estimated doses from individual companies, based on dose rates and exposure times; and information from literature reviews based on dose assessments.

### 5.1 Nuclear industry

Two areas of the nuclear industry provided details of dose rates around each of the main categories of packages (Collier, 2002, Ingman, 2002). This information, together with estimated exposure times facilitated the calculation of estimated worker doses. As transport is only a small proportion of the work carried out by most nuclear industry workers it was not possible to estimate doses based on actual dose records.

Other details of individual doses received by workers transporting nuclear fuel cycle materials were taken from reports produced by NRPB (Gelder, 1991, Gelder 1996) and WNTI (Wilkinson, 2002) for each of the transport modes. The average dose to a nuclear fuel cycle transport worker was found to be below 0.5 mSv per year. The maximum annual worker dose was found to be of the order of 0.5 to 0.7 mSv per year for road and sea transport. The maximum rail worker dose was found to be 0.14 mSv  $y^{-1}$ , these workers are rail handlers, working at the rail head, their average doses are around 40  $\mu\text{Sv } y^{-1}$ . Other rail workers receive average doses of the order of 2  $\mu\text{Sv } y^{-1}$ .

### 5.2 Medical and industrial uses of isotopes

Information on doses from radioisotope supply and distribution by road was provided by the main UK producer of these materials. Individual doses to cargo handlers and aircrew were taken from the recent NRPB report on Air transport (Warner Jones, 2003); where doses to air crew from regular transport of radioactive materials by air were estimated based on dose rate measurements aboard aircraft together with the Radioactive Traffic Factor (RTF)<sup>8</sup> and assumed flying hours. The bulk of radioactive materials transported by air is carried onboard cargo aircraft where dose rates in crew occupied areas are reduced significantly by shielding from other cargo. Average aircrew doses from short haul flights (assessed rather than measured, and only considering dose from the cargo) were found to be of the order of 2  $\mu\text{Sv } y^{-1}$ , with maximum doses of up to 80  $\mu\text{Sv } y^{-1}$ . Doses from long haul flights were slightly higher due in part to the longer flight times and also due to the higher RTF for these flights.

---

<sup>8</sup> The RTF is a measure of the likelihood of a person flying onboard an aircraft that contains a radioactive cargo. This value was determined by calculating the ratio of radioactive cargo flights to all flights.



The Health and Safety Executive of the UK produces annual reports of doses from all classified workers in the UK. These reports are produced from information on the Central Index of Dose Information (CIDI). Data on CIDI are categorised by worker type, and include a category for transport workers. Dose information for workers in other areas of the nuclear industries for whom transport work is only a small part of their remit are not included in the transport worker calculations.

Exposure data for the years 1989 to 2001 have been obtained from the CIDI database for classified transport workers (CIDI, 1993-2002). These data are presented in table 2 and figure 3 below. CIDI data for the 78 classified transport workers in 2001 give a mean dose of 0.7 mSv, and a collective dose of 53 man mSv. The number of classified transport workers has decreased each year (with the exception of 2000); this is due in part to the fact that the majority of the workers do not need to be classified. Most transport workers are monitored to assess their annual doses but do not necessarily require to be classified radiation workers.

Table 2. Classified Transport workers in the UK 1989-2001

Year	Dose Range mSv									Total workers	Coll. Dose man mSv	Mean dose mSv
	0-0	0.1-1	1.1-5	5.1-10	10.1-15	15.1-20	20.1-30	30.1-50	50.1+			
1989	68	224	67	42	7	2	0	0	0	410	643	1.6
1990	47	206	91	38	3	0	0	0	0	385	613	1.6
1991	72	170	65	7	0	0	0	0	0	314	261	0.8
1992	65	173	16	4	2	0	0	0	0	260	160	0.6
1993	61	122	34	6	0	1	1	0	0	225	190	0.8
1994	49	89	23	3	2	0	2	0	0	168	171	1
1995	53	68	15	11	7	0	0	0	0	154	211	1.4
1996	46	80	10	8	2	0	0	0	0	146	134	0.9
1997	24	80	19	8	1	0	0	0	0	132	151	1.1
1998	37	79	15	8	0	0	0	0	0	139	130	0.9
1999	27	26	27	3	1	0	0	0	0	84	107	1.3
2000	34	37	23	2	0	0	0	0	0	96	78	0.8
2001	27	31	20	0	0	0	0	0	0	78	53	0.7

Figure 3. Classified Transport workers in the UK 1989-2001

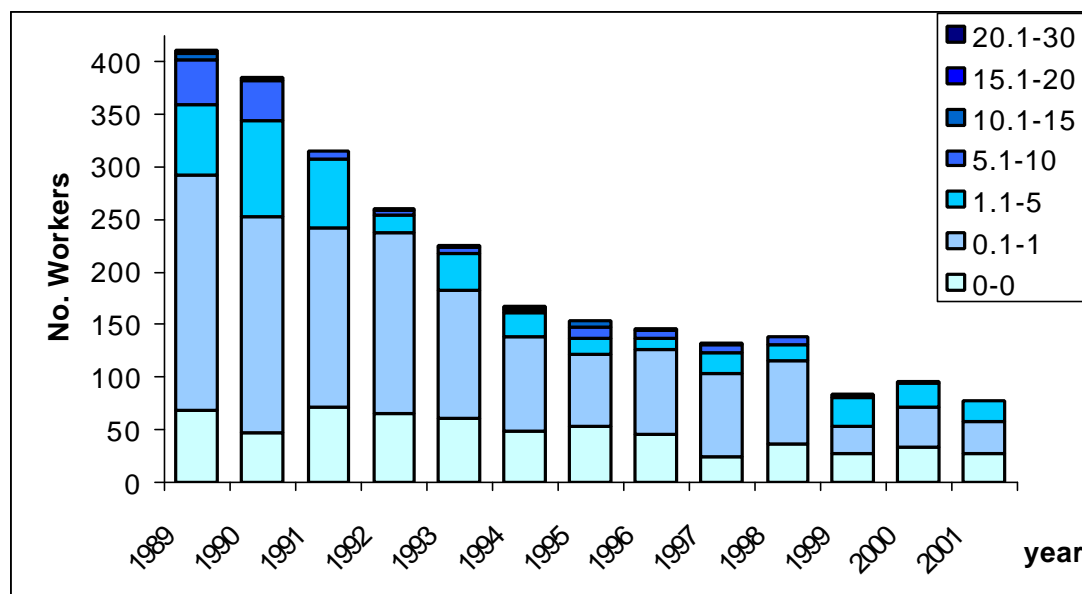

### 5.3 Radiation sources

Assessment of doses from the transport of nuclear density gauges was provided by a Radiological Protection Advisor (RPA) to the industry (Shaw, 2002). The assessment includes information on dose rates, exposure times and distances. Dose rate information for radiography sources was also provided.

A dose rate of approximately  $7\mu\text{Sv h}^{-1}$  can be received by the driver of a vehicle carrying a nuclear density gauge. The maximum exposures would be received by employees at a large consultancy firm specialising in road construction work. These workers are likely to be transporting the gauge 3 to 4 days per week, 45 weeks per year, for around 2 hours per day,. The maximum annual exposure time is therefore 360 hours, which at  $7\mu\text{Sv h}^{-1}$ , could result in an annual dose to these workers of about 2.5 mSv.



The average dose to a nuclear density gauge operator received during the transport of this equipment is about  $1.5 \text{ mSv y}^{-1}$ , resulting from approximately 100 site visits. The minimum dose will be received by operators who do not carry out this work regularly. Their annual dose was assessed to be around  $0.1 \text{ mSv}$  equivalent to 7 site visits per year.



It is not possible to determine accurate dose estimates for the transport of these sources from dose records, as most of the dose will be received whilst using the instrument, rather than during the transport of the shielded instrument. This is also true for industrial radiographers whose average annual dose for 2001 was  $5.1 \text{ mSv}$  (CIDI, 2002). The dose from transporting the sources would be just a fraction of this dose. An average annual dose for the transport of industrial radiography sources is estimated to be  $0.1 \text{ mSv}$  with a range of  $0.01$  to  $0.5 \text{ mSv}$ .

#### 5.4 Consumer products

Annual worker doses from the transport of consumer products were taken from the EC study on consumer products completed in 2001 (Gelder, 2001). In this study, dose rate measurements were made near pallets of smoke detectors. These values together with predicted exposure times for road and sea transport resulted in an average dose to the worker of  $0.1 \text{ } \mu\text{Sv}$  with a range up to  $1 \text{ } \mu\text{Sv}$ .

#### 6. Public dose statistics

Individual doses received by critical group members of the public have been assessed in many studies (Gelder, 1991, Gelder 1996, Warner Jones, 2003, Lange, 1998). In normal transport conditions, external exposure to packages is the only dose pathway that contributes to individual dose. Critical have been defined for four areas of radioactive materials transport. These being: members of the public present at a regular stop for road transport of nuclear fuel cycle materials; members of the public living near to a rail siding used for the transport of nuclear fuel cycle materials; members of the public onboard a ferry containing radioactive materials (not spent fuel shipments) and in an aircraft transporting radioisotopes.

The dose to a member of the public living or working in the vicinity of a regular transport stop (such as traffic lights or a petrol station) has been assessed in a number of studies. A recent study carried out by WNTI (Wilkinson, 2002) found the public dose from this route to be less than  $4 \text{ } \mu\text{Sv y}^{-1}$ . Public doses from sea transport of radioactive materials were found to be up to  $20 \text{ } \mu\text{Sv y}^{-1}$ .

Members of the public living near to a railhead used for the shunting etc of rail wagons containing fuel flasks may receive doses of up to  $6 \text{ } \mu\text{Sv y}^{-1}$  (Gelder, 1991).

The recent study into the transport of radioactive materials by air (Warner Jones, 2003) included a survey onboard a passenger aircraft containing packages of radioactive materials. Dose rate measurements together with the planned flight time enabled a dose calculation for this particular flight. As the RTF for short haul passenger flights is approximately 1 in 800 it is highly unlikely that a passenger will fly in coincidence with radioactive cargo on more than one occasion per year.

Radioactive materials tend to be carried on the same flight each day. Therefore, it is possible that a passenger may fly in coincidence with radioactive materials regularly if they always take the same flight, and this is the flight containing radioactive materials. The average dose for the flight studied was 4.5  $\mu\text{Sv}$  – most seats having a total dose over the flight of less than 1  $\mu\text{Sv}$  (Warner Jones, 2003). The maximum dose for this flight was 30  $\mu\text{Sv}$  in one particular seat. As the material on each flight will have different dose rates, and be loaded into different areas of an aircraft, only an average dose can be used in estimating the critical dose to a frequent flyer. This dose is unlikely to exceed the maximum dose for this one flight.

Table 4 Estimated worker and public doses for the transport of radioactive materials

Transport Operations	Annual effective Dose ( $\mu\text{Sv}/\text{y}$ )			
	Transport Workers		Public (Critical group)	
	Avg.	min./max.	Avg.	min./max.
Nuclear Fuel Cycle				
Road	430	10/670	na	<4
Rail	40	1/140	na	<6
Air	na	na	na	na
Sea	na	0/550	na	<20
Radioisotope Supply and Distribution				
Road	1000	10/7000	na	na
Rail	nr	nr	nr	nr
Air	10	0.1/2000	4.50	0/20
Radiation Sources				
Radiography	100	10/500	na	na
Nuclear density/gauging devices	1500	100/2500	na	na
Non-nuclear Wastes				
Medical/research/industry	na	na	na	na
Consumer Products				
Road/Rail/Air/Sea	0.1	0/1	na	na

na: not available

nr: not relevant

## 7. Discussion and Conclusions

Data on the transport of radioactive materials by each mode of transport is gathered on a 10 year rolling cycle and produced together with dose information for both workers and public in reports on behalf of the Department for Transport. Data for air transport was gathered in 2002 containing information on movements occurring in 2001. The most recent data for sea transport was published in 1996, and road and rail transport in 1991. As the latter data is now outdated, information for movements in 2001 was sought from producers, suppliers and distributors. This information, together with the data from the air study was gathered together and analysed for this review.

In 2001, there were 863 loaded fuel flask movements, and an approximately equal number of discharged flask movements by rail. These movements resulted in individual doses to the workforce of up to 140  $\mu\text{Sv}$ , the average dose to the workforce was about 2 $\mu\text{Sv}$ . There has been a gradual increase in the number of flask movements per year. There were over 2200 shipments of fuel cycle materials for the production of new fuel in 2001, each with dose rates to the driver of the order of 2  $\mu\text{Sv h}^{-1}$ . Therefore a driver, transporting these materials for 500 hours per year would receive a dose of approximately 1  $\text{mSv y}^{-1}$ .

The number of packages containing medical and industrial isotopes does not vary considerably from year to year. Advances in package design have meant that almost all Type A packages (except for technetium generators) have a TI of 0.0. Around a third of all medical and industrial packages contain technetium generators equating to around 3000 per month for export to Europe. This will increase to around 4000 generators per month in 2003. Cargo handlers at UK airports received measured doses of up to 2  $\text{mSv y}^{-1}$  in 2000 and 2001 (Warner Jones, 2003). Delivery drivers received doses of up to 6.7  $\text{mSv}$  in 2000 for the main UK carrier (Carrington, 2002).

## 8. Acknowledgements

The author is grateful to the many individuals and organisations that supplied information, their assistance has been most valuable in compiling up to date transport shipment and dose statistics.

## 9. References

Airey, G., Nottingham Asphalt Research Consortium, 2002

Barton, N., DfT, personal correspondence, 2002

Bennett, J., British Energy, personal correspondence, 2002

Carrington, C., Amersham, personal correspondence, 2002

Central Index of Dose Information, summary of statistics for 1989. HSE 1993

Central Index of Dose Information, summary of statistics for 1990. HSE 1993

Central Index of Dose Information, summary of statistics for 1991. HSE 1993



- Central Index of Dose Information, summary of statistics for 1992. HSE 1994
- Central Index of Dose Information, summary of statistics for 1993. HSE 1995
- Central Index of Dose Information, summary of statistics for 1994. HSE 1996
- Central Index of Dose Information, summary of statistics for 1995. HSE 1997
- Central Index of Dose Information, summary of statistics for 1996. HSE 1997
- Central Index of Dose Information, summary of statistics for 1997. HSE 1998
- Central Index of Dose Information, summary of statistics for 1998. HSE 1999
- Central Index of Dose Information, summary of statistics for 1999. HSE 2000
- Central Index of Dose Information, summary of statistics for 2000. HSE 2001
- Central Index of Dose Information, summary of statistics for 2001. HSE 2002
- Collier, E., BNFL Springfields/Westinghouse, personal correspondence, 2002
- Gelder, R., Radiation Exposure from the Normal Transport of Radioactive Materials within the United Kingdom, 1991 Review. NRPB–R255, Chilton 1991.
- Gelder, R., Radiological Impact of the Normal Transport of Radioactive Materials by Sea, NRPB–M749, Chilton 1996.
- Gelder, R. et al., Transport of Consumer Goods containing Small Quantities of Radioactive Materials, Final Report (EC Contract No. 4.1020/D/99-006 (DG TREN)), Mar. 2001
- Ingman, M., Urenco Capenhurst, personal correspondence, 2002
- Lee, B., Magnox, personal correspondence, 2002
- Lange, F. et al., Assessment of the Radiological Risks of Road Transport Accidents involving Type A Packages, Final Report (EC Contract No. 4.1020/D/96-002 (DG XVII)), Oct. 1998
- Shaw, J., Occupational Services, NRPB Leeds, personal correspondence, 2002
- Talbot, R., UKAEA (and information from AEAT), personal correspondence, 2003
- Warner Jones, S. M. et al., Survey into the Radiological Impact of the Normal Transport of Radioactive Material by Air. To be published.
- Wilkinson, W. L., Radiation Dose Assessment for Transport of Nuclear Fuel Cycle Materials, WNTI, as presented at InucE International Conference on Radioactive Materials Transport, 5-7<sup>th</sup> November 2002. Edinburgh To be published by Nuclear Technology Publishing.
- Wilkinson, W. L., WNTI, personal correspondence, 2002



**Annex 2**

**Statistics on the Transport of Radioactive Material in Germany  
and the Radiation Doses arising from such Transports  
German Contribution  
Draft**

Work performed under  
EC Contract Reference No. TMR 2001/300 (DG TREN):  
Statistics on the Transport of Radioactive Material and Statistical Analyses

Compiled by:  
G. Schwarz, H.-J. Fett, F. Lange  
Gesellschaft für Anlagen- und Reaktorsicherheit (GRS) mbH  
Schwertnergasse 1, 50667 Cologne, Germany

14. November 2002

## List of contents

### **Introduction**

### **Data collection and analysis approach**

### **Type and magnitude of and time trends in radioactive material transport**

Nuclear material and large-quantity radiation sources

Nuclear and non-nuclear radioactive material shipments

### **Radiation exposures of transport workers and members of the public**

### **Discussion, conclusions and recommendations**

### **References**

## Introduction

Radioactive materials of natural or artificial origin are of widespread use in developed societies all over the world and are consequently transported within and between countries. They are used in medicine, research, industrial manufacturing, agriculture, nuclear power generation and in other applications that assist our daily lives and cover a wide range of materials and commodities from very small quantities incorporated in consumer products or radiopharmaceuticals for medical uses to very large quantities of spent nuclear fuel and vitrified radioactive waste generated in the nuclear fuel cycle. By its radioactive nature the handling, use and application of radioactive material (RAM) including their transport gives rise to potential radiological (and non-radiological) hazards; the resultant radiological risks must be constrained below unacceptable levels.

Although the existing regulatory controls governing the safe transport of radioactive material worldwide, i.e. the Transport Regulations developed, maintained and disseminated by the International Atomic Energy Agency (IAEA), are deemed to provide a suitable level of safety and protection of people, property and the environment for all modes (road, rail, sea and waterways, and air) and conceivable conditions of transport, a broad understanding of the type, volume and trends in radioactive materials shipments and the radiation exposures arising from such transports is of paramount importance for a number of reasons including the following:

- demonstrate the efficacy of the Transport Regulations,
- provide input and support to the continuous review and revision process of the Regulations and national and international transport regulatory activities,
- satisfy the requirements of Euratom Basic Safety Standards, Article 14<sup>9</sup>, and the IAEA Transport Regulations, para 304 TS-R-1, which call for periodic assessment of the radiation exposure of persons to be carried out and reasonable steps be taken by EU Member States to ensure that exposures from practices are kept as low as reasonably achievable,
- ensure a sound basis for monitoring needs and trends in transport and exposure conditions,
- assist operators and competent authorities (compliance assurance program) in the establishment of good practice and sound management principles and criteria, e.g. by providing up-to-date information for judging the adequacy of operational procedures and the effectiveness of operator's radiation protection provisions to control the radiological (occupational and public) hazards associated with the transport of radioactive material,
- support and guide dose and risk assessment activities, e.g. by providing up-to-date information relevant for the assessment and evaluation of radiation doses and risks to workers and members of the public from normal transport and potential incidents and accidents,

---

<sup>9</sup> Council Directive 96/29/Euratom, Article 14: Each Member State shall take reasonable steps to ensure that the contribution to the exposure of the population as a whole from practices is kept as low as reasonably achievable, economic and

- provide factual information to meet public information needs,
- support and promote the development and maintenance of international transport safety databases, e.g. the IAEA operated SHIPTRAM and EXTRAM databases.

In recognition of this need work has been undertaken with the principal objective to identify, collect, compile and analyse statistical information on the type, magnitude and relevant shipping characteristics of radioactive material transport in Germany and the related radiation doses received by transport workers and members of the public from normal (incident-free) transport operations.

This paper represents the German contribution to this multi-national EC Research Project and identifies the principal sources and type of information available nationally and being used for this study and the methods applied for the collection and analysis of statistical transport and exposure data and summarises the principal findings and conclusions of this exercise.

### **Data collection and analysis approach**

The availability of and ease of access to statistical transport and exposure data differs widely in Germany depending on the applicable national institutional and regulatory requirements and a range of other constraints. For example, while the transport of some categories of radioactive materials is subject to stringent governmental regulatory controls through a system of prior-approval and pre-notification, e.g. particularly for nuclear fuel cycle material shipments, other radioactive material shipments are less stringently supervised consistent with the applicable regulatory requirements and their lower radiological hazard. Other factors which limit the general availability of such data and need to be taken into account include the commercial sensitivity of such data and the personal and financial effort required for the collection and analysis of transport data. Consequently, the scope, level of detail and frequency of collection and analysis of statistical transport and exposure data varies widely depending on the type of radioactive material and mode of transport.

Traditionally, shipments of fissile material and large-quantity radiation sources by all modes have been more intensively controlled by the national competent authorities than other radioactive material categories and, hence, the level of information for the transport of fissile material and large-quantity radiation sources is principally broader for this material category. The most recent transport data for fissile materials and large-quantity radiation sources were - in addition to other pertinent sources of information - made available for compilation and analysis and are described below. Statistical occupational and public exposure data, however, are generally not being collected, reported and published by transport operators and competent authorities on a routine basis and, therefore, other collection and analysis methods have been employed for the study purpose.

Hence, the statistical transport and exposure data presented in this paper have been drawn from a variety of pertinent sources of information and included specifically designed questionnaire surveys of transport related information, site visits of major transport operators, dose assessment studies, the open literature and other relevant compilations of transport data. This level of information is complemented by the results of personal radiation monitoring programs and assessments of radiation doses received by transport workers and members of the public under normal (incident-free) conditions of transport. To some extent advantage was taken of compilations of transport and exposure data collated within other projects including former EC-funded research projects, e.g. van Hienen (Ed.) 1999.

It is being noted, that the terminology being used to describe the movement of radioactive materials by the various means of transport is not uniquely defined in the transport community and essentially left to the discretion of the transport operators, e.g. the consignor or shipper. For example, a truck load of numerous radiopharmaceutical packages destined for different consignees being moved from the production site to an intermediate destination, e.g. a distribution centre, may be considered either as a single multiple-package shipment or as differing shipments of packaged radioactive material for various consignees being carried on the same vehicle and counted accordingly as multiple radioactive material shipments. Thus, throughout this paper the term “shipment” has been used to denote the carriage of radioactive material from the origin to the intermediate/final destination by a specific means of transport as specified in the transport document. A so-defined radioactive material shipment may consist of a single package/flask or of multiple packages/flasks.

---

social factors being taken into account. The total of all such contributions shall be regularly assessed.

## Type and magnitude of and time trends in radioactive material transport

### Nuclear material and large-quantity radiation sources

The statistical transport data currently available for the recent years are limited in scope and relate to the annual number of domestic and transboundary shipments of nuclear material and large-quantity radiation sources, i.e. fissile material or radioactive material containing fissile constituents and packaged radiation sources having a total activity per package in excess of 1000 TBq. The shipment data concerning this material category have been acquired from the national competent authority for analysis and compilation and refer to the calendar year 2001 and are presented in Figure 1.

The total annual number of domestic and international radioactive material transports referred to in Figure 1 is approximately 390 shipments per year and - with very few exceptions - related to nuclear fuel cycle activities in Germany. Shipments of non-irradiated nuclear materials such as fresh nuclear fuel elements and fuel pins, uranium hexafluoride (UF<sub>6</sub>) and UO<sub>2</sub>-pellets/powder represent the largest fraction of these transports in the calendar year 2001. Transports of high-level radioactive material which are a primary concern and of interest to the public and the media are relatively limited in the reporting period (2001) and included 47 shipments of spent nuclear fuel elements and fuel pins and 2 multiple-package shipments each comprising six flasks with vitrified high-level radioactive waste being returned from the La Hague reprocessing plant, France, for interim storage at the Interim Storage Facility (TBL-G) in Gorleben.

Figure 1 indicates that the large majority of transports of nuclear material and large-quantity radiation sources in the reporting period is by road and to a lesser extent by sea. For large quantities of nuclear materials and vitrified reprocessing waste packaged in purpose-built massive transport flasks or dual-purpose CASTOR HAW flasks, however, rail transportation is the primary shipping mode. Air transportation of radioactive materials referred to in Figure 1 is limited to non-irradiated fuel cycle material.

In respect to the transport relationship international and transit movements are prevailing in the transport of nuclear material and large-quantity radiation sources.

Although consistent and reliable information for monitoring trends in radioactive material shipments is generally sparse in Germany - if available at all -, for some categories of radioactive material shipments long-term trend data exist. Figure 2 provides an overview on the time trend in the volume of commercial reactor spent nuclear fuel transports for the time period from 1970 - 2001. It is seen from Figure 2 that the annual volume of commercial spent nuclear fuel shipments - research reactor nuclear fuel and irradiated fuel pins excluded - has consistently been in the range of about 60 - 100 shipments annually over the last two decades following an initial phase of fewer spent fuel shipments in the seventieth. Commercial spent nuclear fuel transports relate basically to both the carriage of spent nuclear fuel to foreign destinations in the UK and France for reprocessing and nationally existing dry cask interim storage facilities in Ahaus and Gorleben. From April 1998 through 2000 commercial reactor spent nuclear fuel transports were temporarily banned in Germany (and other European countries) after disclosure of elevated levels of surface contamination on shipping casks.

### Nuclear and non-nuclear radioactive material shipments

Due to the significant effort required for the gathering and compilation of radioactive material transport data, the collection, analysis and reporting of shipment data for the wide range of radioactive substances being applied or arising from the various applications of radioactive substances and radioisotopes in medicine, research and industry is generally limited to periodic assessments in Germany (and probably in most other EU Member States). The most comprehensive and consistent set of information currently available in Germany on the type and magnitude of nuclear and non-nuclear radioactive material shipments is based on a nationwide survey of domestic and international radioactive material transports and other pertinent sources of information. The nationwide radioactive material transport survey was performed using questionnaire forms and making site visits and was completed in the early ninetieth. The nationwide transport survey covered all shipping modes, i.e. road, rail air and sea, and all major categories of radioactive materials with emphasis on radioactive substances falling in the realm of the Transport Regulations (1985 Edition). Consumer products, components and devices containing small quantities of radionuclides were excluded from the survey.

Radioactive material transport survey results by field of application: Radioactive material transport practices affecting the public domain can generally be related to two broad categories of material:

- Nuclear (i.e. fissile) material
- Non-nuclear (i.e. non-fissile) radioactive material

Nuclear (fissile) material shipments are primarily related to nuclear fuel cycle activities and research and development and include, for example, shipments of pre-fuel material, fuel pins, non-irradiated and irradiated fuel assemblies and samples of fissile material or materials containing such constituents. Non-nuclear (non-fissile) radioactive materials are typically used in a wide range of industrial, scientific and medical applications and may be further categorized in three major subgroups depending on their origin or end-use:

- Nuclear fuel cycle material
- Radiographic and other radiation sources, e.g. gauging, testing and monitoring equipment
- Radioisotopes for medical, scientific and industrial applications.

The level of information acquired in the radioactive material transport survey permitted generally categorisation of a radioactive material shipment by field of application and the analysis results are given in Table 1. The radioactive material transport survey results are most representative for the early ninetieth and West Germany (former GDR excluded).

The survey results indicate that non-nuclear radioactive material shipments for applications in various disciplines of medicine, research and industry represent the largest fraction of the radioactive material transports in Germany with an annual volume of about 443 000 shipments per year. The materials shipped are typically radiopharmaceuticals, labelled compounds in gaseous, liquid or solid form for scientific purposes, and monitoring, testing and gauging devices for numerous industrial applications but include also substances such as natural and depleted uranium and non-nuclear radioactive waste. A significant fraction of these radioactive material shipments contain relatively small quantities of radioactivity in the range of a few Kilo-Becquerel to a few Giga-Becquerel for medical, scientific and industrial use in packagings within the excepted package criteria of the Transport Regulation. The preferred mode of transport for this category of material is by road and air. Approximately 99 percent of the total traffic relates to the category of non-nuclear radioactive materials with a cumulative travel distance of about 43 million kilometres.

**Table 1: Transport of Radioactive Material in Germany by Field of Application**

Type of material and field of application	Shipments (per year)	Packages (per year)	Cumulative activity (TBq)	Distance travelled <sup>a)</sup> Mill. km)
<u>Fissile material:</u>				
Nuclear fuel cycle, research and development <sup>b)</sup>	1 900	9 500	24 x 10 <sup>6</sup>	0.4
<u>Non-fissile radioactive material:</u>				
- Nuclear fuel cycle	6 630	26 000	ca. 500	1.2
- Radiographic and other radiation sources	65 000	75 000	--	6
- Medicine, research, industry	370 000	815 000	ca. 70 000	35
Total (rounded)	445 000	---	24 x 10 <sup>6</sup> <sup>b)</sup>	44
a) Travel distance by road and rail				

b) Total activity for all modes of transport

Transport of portable radiographic and other radiation sources, e.g. for industrial (moisture/density) gauging and for calibration, testing and operation of instrumentation, accounts for a total of approximately 65 000 shipments and 75 000 shipped packages. The activity per shipment of radiographic and other radiation sources varies substantially but is generally in the range of a few Giga-Becquerel to some Tera-Becquerel. Type A and Type B packages are prevailing in transports of radiographic and other radiation sources. Unlike other point-to-point radioactive material shipments, transports of portable radiation sources are typically roundtrips, i.e. shipments start at the user's office/depot to the site of application and return to this point some time later after usage of the radiation source. The road travel distance for this radioactive material category was estimated to be approximately 6 million kilometres. Fissile and non-fissile radioactive material shipments related to nuclear fuel cycle activities represent only a small fraction of the total number of radioactive material shipments in Germany. The percentages of the fissile and non-fissile nuclear fuel cycle material shipments are 0.4 % (1900 shipments/yr) and 1.5 % (6630 shipments/yr), respectively. In contrast, however, the total radioactivity of 24 million Tera-Becquerel shipped in the public domain is almost exclusively related to nuclear fuel cycle activities. The fissile fuel cycle material category encompasses a range of radioactive substances, but consist - similarly to the 2001 shipment data - primarily of non-irradiated materials such as U 235-enriched pre-fuel materials (UF<sub>6</sub>, U<sub>3</sub>O<sub>8</sub>, UO<sub>2</sub>-powder/pellets etc.), fuel pins, and fresh fuel assemblies. The number of irradiated nuclear (fissile) material shipments is less than 10 percent (160 out of 1900) of the number of all fissile material shipments and includes primarily spent nuclear fuel, irradiated fuel pins, and Plutonium (Pu) and Pu-containing compounds. The non-fissile fuel cycle material category involves various packaged substances such as unloaded transport flasks containing residual radioactivity, natural and depleted uranium (uranium ore, uranium ore concentrate, uranium hexafluoride), radioactive waste and contaminated/activated equipment and components. The preferred mode of transport of this radioactive materials is by road. Included in this category is a substantial fraction (approx. 50 percent of packages) of small quantities (samples) of radioactive material in excepted packages shipped by air. It is of interest to note, that the currently relevant total number of nuclear material shipments of approximately 390 shipments annually in 2001 has apparently significantly declined compared to the relevant values of approximately 1900 shipments annually given for the nineties (see Table 1). This may partly be attributable to the discontinuation of services of a German manufacturing company of nuclear fuel assemblies in the middle of the nineties which was known to ship routinely large numbers of non-irradiated nuclear fuel pins between different manufacturing sites.

Radioactive material transport survey results by mode of transport: The mode-specific transport survey results in terms of the number of radioactive material shipments and packages, the total radioactivity shipped and travel distance of radioactive materials moved in Germany (former GDR excluded) are shown in Table 2. The total annual number of radioactive material shipments is approximately 445 000 per year for all modes of transport, i.e. road, rail, air and sea. Road transportation represents the most dominant shipping mode with an annual volume of about 410 000 shipments and 665 000 shipped packages. Transportation by air ranks second with approximately 19 000 shipments annually and a total of 240 000 shipped packages, i.e. most shipments are multiple package shipments. The annual radioactive materials transports by rail total about 15 500 shipments and 17 000 shipped packages. The data on radioactive material shipments by sea are of a preliminary nature but the annual transport volume has been estimated to be on the order of about 500 shipments and 2 000 packages.

**Table 2: Transport of Radioactive Material in Germany by Mode of Transport**

Transport Mode	Shipments (per year)	Packages (per year)	Cumulative activity (TBq)	Distance travelled <sup>1)</sup> (Mill. km)
Road	410 000	665 000	7 x 10 <sup>6</sup>	40
Rail	15 500	17 000	22 x 10 <sup>6</sup>	< 4
Air	19 000	240 000	<< <sup>2)</sup>	---



Sea	500 <sup>4)</sup>	2 000 <sup>4)</sup>	--- <sup>3)</sup>	---
Total	ca. 445 000	---	---	44
1) Travel distance within Germany 2) "<<" = Value very small 3) "---" = Value currently not available 4) Best estimate based on limited data				

In respect to the amount of radioactivity being shipped in the public domain the largest quantities of radioactivity are shipped by rail. This is because large quantities of radioactive material such as spent nuclear fuel, irradiated fuel pins and bulk quantity radiation sources are primarily transported by rail. Road transportation of large quantities of radioactive material is generally limited to the movement of spent nuclear fuel transport flasks from its origin to the nearest transfer point, whether by train or ship and vice versa. The radioactivity inventory of packages carried by air is typically small and, hence, these packages contribute collectively only insignificantly to the total radioactivity being moved in the public domain.

The total travel distance of radioactive material shipments by road and rail has been estimated to be on the order of 44 million kilometres. This corresponds to an average travel distance of about 100 km per shipment. Most of the travel distance in the public domain is associated with the movement of radioactive material by road vehicles. For sea and air transportation radioactive material travel distances are not available.

There are indications that the transport volume of radioactive material by rail and air has declined in the recent years; in particular German Railways (DB) no longer accepts individual radioactive material packages (Stückgut, Expressgut) for transport by rail unless they are shipped as complete railcar loads.

#### **Radiation exposures of transport workers and members of the public**

Most radioactive materials transported emit penetrating ionising radiation and radiation exposures of transport workers and the public may occur during their transport. The magnitude and frequency of the possible radiation exposures being incurred by a transport worker or member of the public depend on several factors: most important is the type of emitted radiation, the package radiation field intensity in the vicinity of the package and conveyance, the duration of exposure, the distance and shielding provided between the packages/conveyances and the persons concerned and the number of packages prepared or handled by an individual worker and the number of vehicle movements on a path of travel of radioactive material shipments.

For radiological protection in transport it is important to recognise that the package radiation dose rate is limited to levels allowed under the Regulation, but experience indicates that most radioactive material packages have radiation levels and radionuclide inventories well below the regulatory limits, e.g. Lange et al. 1998, Raffestin et al. 1998. In addition, the Regulations require consignors/shippers of radioactive materials to provide an acceptable level of control of the radiation to persons, property and the environment and to optimise safety and protection to levels "as low as reasonably achievable".

In order to assist and guide the assessment and evaluation of the optimisation of safety and protection in the transport of radioactive material work has been undertaken with the objective to provide up-to-date information on the magnitude of occupational and public radiation exposures arising from normal (incident-free) transport activities. The information currently available and presented subsequently is based on a survey of radiation exposure data gathered from a number of commercial transport operators and organisations in Germany known of having personal radiation monitoring programs in place and being involved in the transport of major quantities of radioactive materials (in terms of the number of packages and amount of radioactivity transported). Dose monitoring of members of the public, however, is generally considered to be impractical and relies on employing radiation dose assessment models and transport model parameters for hypothetical or critical group individuals in such a way to arrive at upper-bound or conservative dose estimates for members of the public.

Table 3 summarises the survey and assessment results in terms of typical maximum occupational and public radiation exposures resulting from the routine (incident-free) transport and handling of radioactive material package shipments in various fields of applications of radioactive substances. The survey and assessment results indicate that the occupational and public exposures arising from routine (incident-free) transport operations of radioactive material shipments are generally in the range or well below of a value of 1 mSv/yr for transport workers (e.g. drivers, package handlers etc.) and 0,1 mSv/yr for members of the public in all major fields of radioactive material transport. Radiation exposures in this dose range represent only a small fraction of the relevant regulatory dose limit for radiation workers and the public of



20 mSv/y and 1 mSv/y, respectively. Figure 3 provides illustrative examples in time trends of occupational radiation doses received by airport personnel (package handler) and truck drivers involved in front & back end fuel cycle material shipments and are indicative that low occupational doses prevail in these transport operations for many years in Germany.

This situation holds basically also for the transport by road and transport-related operations associated with the supply and distribution of medical, scientific and industrial radioisotopes where 80 - 85 percent of transport worker doses are found to be below 1 mSv/year - if exposed at all (cf. Figure 4). Under certain conditions, however, where routinely large volumes of packaged (generally excepted and Type A packages) radioisotopes for applications in medicine, research and industry are shipped and handled, for example, at warehouses and redistribution centres, maximum occupational annual transport worker (drivers/handlers) doses can be as high as 10 - 14 mSv per year. The number of drivers/handlers being exposed to this increased levels is, however, generally limited. The latter observation is a general feature of transport worker dose distributions available from a number of other EU Member States for transport operations of a comparable nature, cf. Figure 5 (Adopted from van Hienen, J.F.A. (Ed.) 1999).

Similarly, site radiographers involved in the transport of radiographic radiation sources for non-destructive testing (NDT) receive typically exposures from both the transport (by road) and field use of such radiation sources. While the transport-related worker doses are typically below 1 mSv per year the additional radiation dose resulting from the field use of the radiation source can be quite significant and has to a significant extent been found to be in excess of the today's dose limit of 20 mSv per year in recent years.

### **Discussion, conclusions and recommendations**

This working paper provides an overview on the available information on the volume and nature of radioactive material transport in Germany and the related radiation exposures received by transport workers and member of the public from such transports under routine (incident-free) transport conditions. The information provided is the most current nationally available and has been gathered and compiled from a variety of pertinent sources of information including a nationwide transport questionnaire survey, site visits of major transport operators, gathering of data from competent authorities, technical documents etc. and covers all major categories of radioactive materials and shipping modes (road, rail, air and sea). The currently best estimate of the magnitude of nuclear (fissile) and non-nuclear (non-fissile) radioactive material shipments in Germany is approximately 450 000 shipment per year (domestic and international) with road transportation being the predominant transport mode. Shipments of radioactive material for applications in medicine, research and industry account with a total of approx. 440 000 shipments annually for the largest fraction of the national transport volume. On the contrary nuclear fuel cycle materials including commercial reactor spent nuclear fuel elements, irradiated and non-irradiated fuel elements and pins, pre-fuel material and operational radioactive waste represent with less than 8 000 shipments annually (i.e. less than 2 percent of the total) only a small fraction of the total volume; in terms of the cumulative radioactivity transported in the public domain nuclear fuel cycle material shipments are, however, clearly the predominant contributor. The transport by road of radiographic and other radiation sources, e.g. for industrial (density/moisture) gauging and calibration, testing and operation of instrumentation, accounts for approx. 65 000 shipments per year. The radioactive material shipment data given above are by its nature most representative for the early ninetieth, but are - where available - broadly compatible with 2001 shipment data.

The comprehensive analysis results on radiation exposures arising from radioactive material shipments underpin the understanding that the transport-related radiation exposures received by transport workers and members of the public under routine (incident-free) transport conditions are generally low in most transport disciplines and with values in the range of or less than 1 mSv/y well below the applicable regulatory dose limits (20 mSv/y for workers and 1 mSv/a for members of the public). A notable exception are transport operations concerning the supply and distribution of radioisotopes for medical, scientific and industrial applications where routinely large volumes of packaged radioisotopes are consigned, handled and shipped resulting in few transport workers receiving maximum annual doses in the range of up to 10 - 14 mSv/y.

The occupational and public radiation doses arising from the transport operations described above are believed to be typical for optimised transport practices and procedures and representative for the implementation and application good practice and sound management principles in transport. Nevertheless, there is no room for complacency in optimisation of protection and safety of people, property and the environment and possible developments, both in operational procedures and equipment in use for transport and handling should be considered. Sometimes improvements in safety and protection can be achieved effectively and at very little costs and thus transport operators should establish regular reviews of their methods of work and equipment.

The availability of up-to date information on the type and volume of radioactive material transport and related exposure data plays an important role in these regular review and optimisation processes and should be regularly examined and updated to ensure that a sound basis of monitoring trends in transport and related exposures exists and guidance be given on the evaluation of the associated radiological risks. Further attention should be paid to the need for and cooperation be promoted between operators and competent authorities to ensure operators, especially the smaller ones, are fully aware of and understand their legal responsibilities and obligations.

Cooperation of operators and national, European and international organisations with responsibilities for the safe transport of radioactive material is also considered to be useful and needed to promote the implementation and application of good practices and sound management principles and criteria in transport of hazardous material including radioactive substances in a growing European Union and internationally.

#### **References**

van Hienen, J.F.A. (Ed.), The Evaluation of the Situation in the European Community (EC) as regards Safety in the Transport of Radioactive Material and the Prospects for the Development of such Type of Transport, Revised Final Report (EC Contract No. 4.1020/D/97-003 (DG XVII)), Feb. 1999

Lange, F. et al., Assessment of the Radiological Risks of Road Transport Accidents involving Type A Packages, Final Report (EC Contract No. 4.1020/D/96-002 (DG XVII)), Oct. 1998

Raffestin, D. et al., Evaluation of the Radiation Protection Options related to the Transport of Low Weight Packages - Category III-YELLOW, Final Report (EC Contract No. 4.1020/D/96-014 (DG XVII)), Jan. 1998

**Table 3: Maximum radiation doses received by workers and members of the public from the normal (incident-free) transport of radioactive material for various transport operations in Germany**

Transport Operations/Field of Application	Transport Mode	Maximum Effective Dose (mSv/y)	
		Workers	Public <sup>a)</sup>
Non-irradiated nuclear fuel cycle material, e.g. U <sub>3</sub> O <sub>8</sub> , UF <sub>6</sub> , UO <sub>2</sub> -powder/pellets, non-irradiated fuel assemblies, radiation sources	Road/Rail	< 1	--- <sup>b)</sup>
	Sea	< 1 <sup>c)</sup>	---
Irradiated nuclear fuel cycle material, e.g. activated/contaminated equipment and components, radioactive waste, irradiated nuclear fuel, vitrified waste, radiation sources	Road	1 - 2	< 0,05
	Rail	< 1	< 0,1
Non-nuclear radioactive waste, e.g. medical and research waste	Road	< 1	---
Transport and distribution of radioisotopes for research, medicine and industry, other radioactive materials	Road	10 - 14	< 0,04
	Air	< 1	---
Radiographic and other radiation sources	Road	< 1 <sup>d)</sup>	---
<b>Regulatory Dose Limits</b>		<b>20</b>	<b>1</b>

a) Relevant to the critical population group, e.g. residents/by-standers or users of the transport route.  
b) „---“ = Data currently unavailable.  
c) Preliminary value derived from the general literature.  
d) Transport-related worker dose without the extra dose received from the field use of radiographic radiation sources.

Transport of Nuclear Material and Large Radiation Sources in Germany (2001)

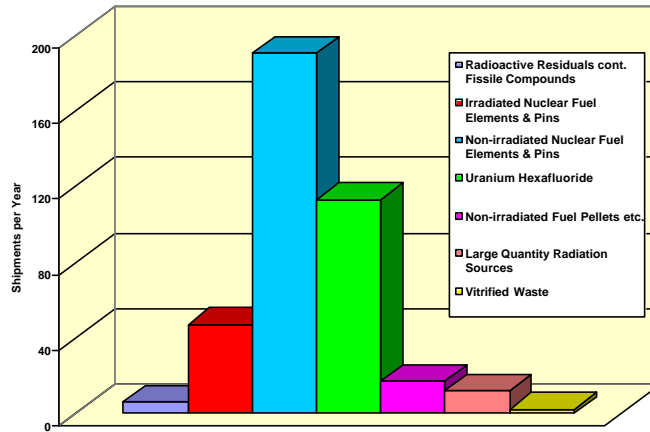

Transport of Nuclear Material and High-Level Radioactive Waste/Residuals in Germany (2001)

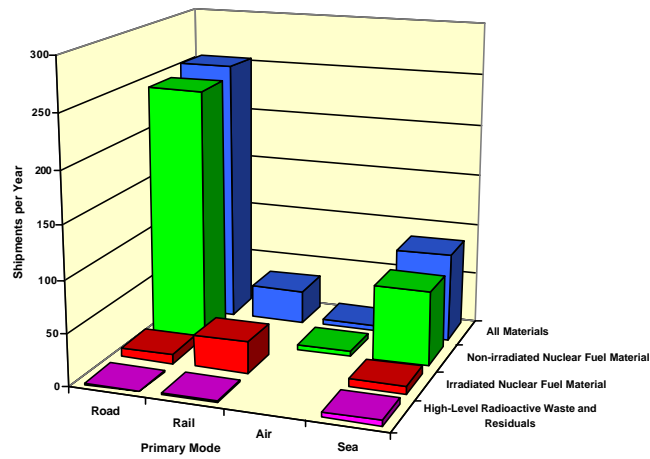

Transport of Nuclear Material and High-Level Radioactive Waste/Residuals in Germany (2001)

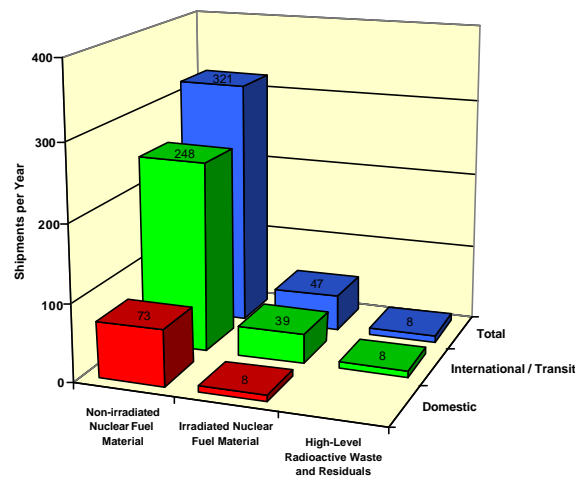

Figure 1: Number and characteristics of shipments of nuclear materials and large-quantity radiation sources in Germany in the calendar year 2001 by category of material (top), by mode (centre) and traffic relationship (bottom)

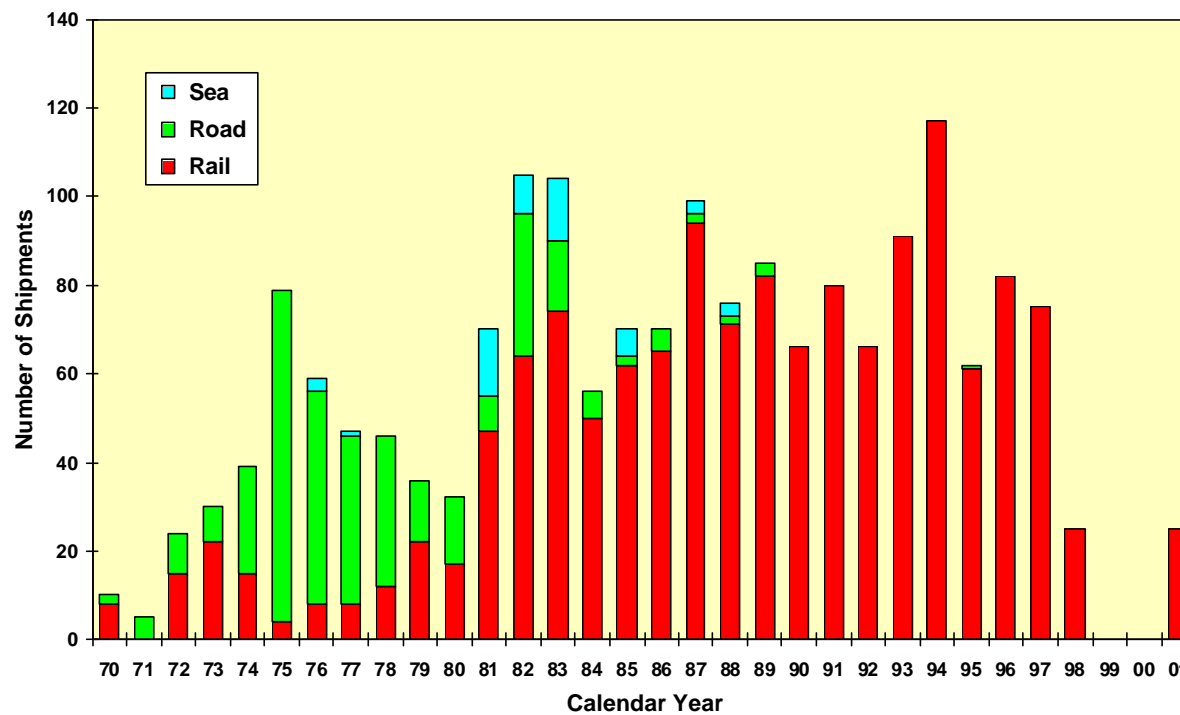
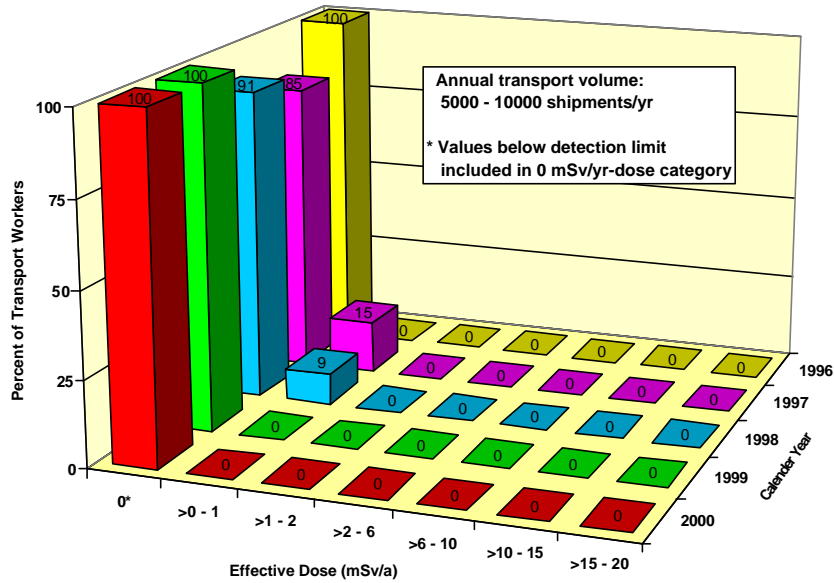

Figure 2: Commercial reactor spent nuclear fuel transport in Germany (1970 - 2001)

Occupational Dose to Airport Personnel (Handler) arising from the Transport and Handling of Radioactive Material Shipments



Transport Worker Radiation Doses (Driver) arising from Radioactive Material Shipments by Road (primarily Front & Back-End Fuel Cycle Material including SNF/HLW/ILW/LLW)

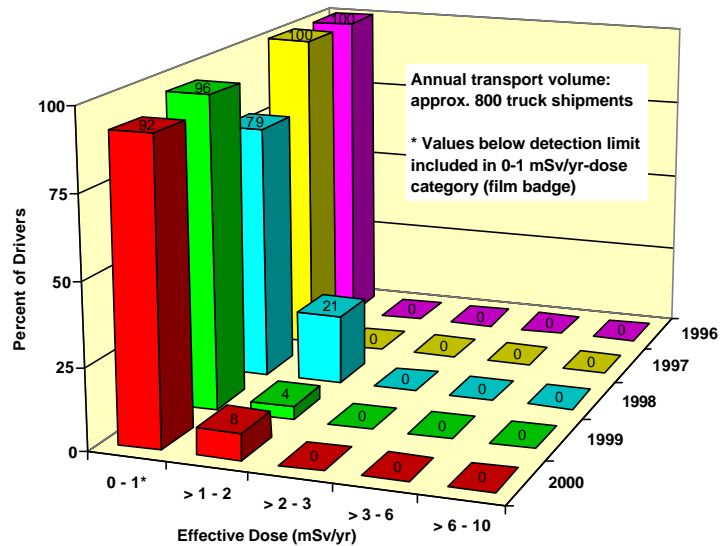

Figure 3: Time trends in occupational radiation exposures of airport personnel (top) and truck drivers involved in front & back end fuel cycle material shipments (bottom) based on routine radiation monitoring program results in Germany

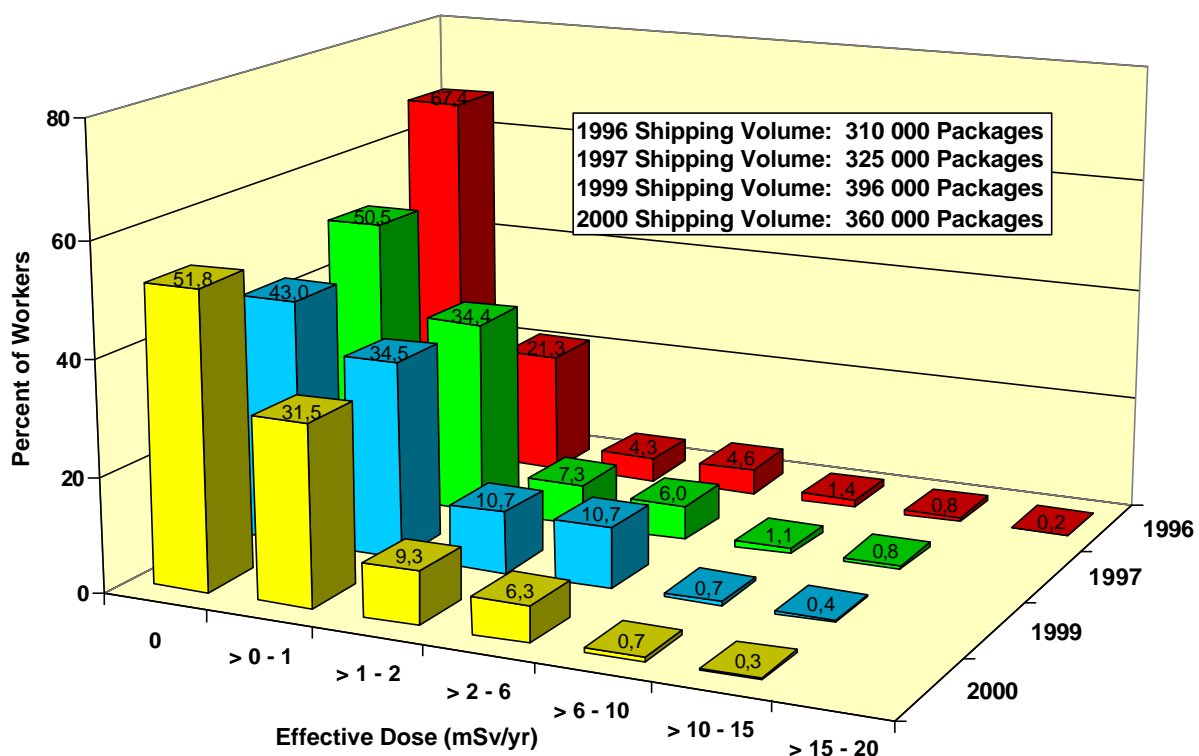

Figure 4: Occupational dose to personnel (drivers/handlers) from the transport (road) and distribution of radioisotopes for medical, scientific and industrial applications

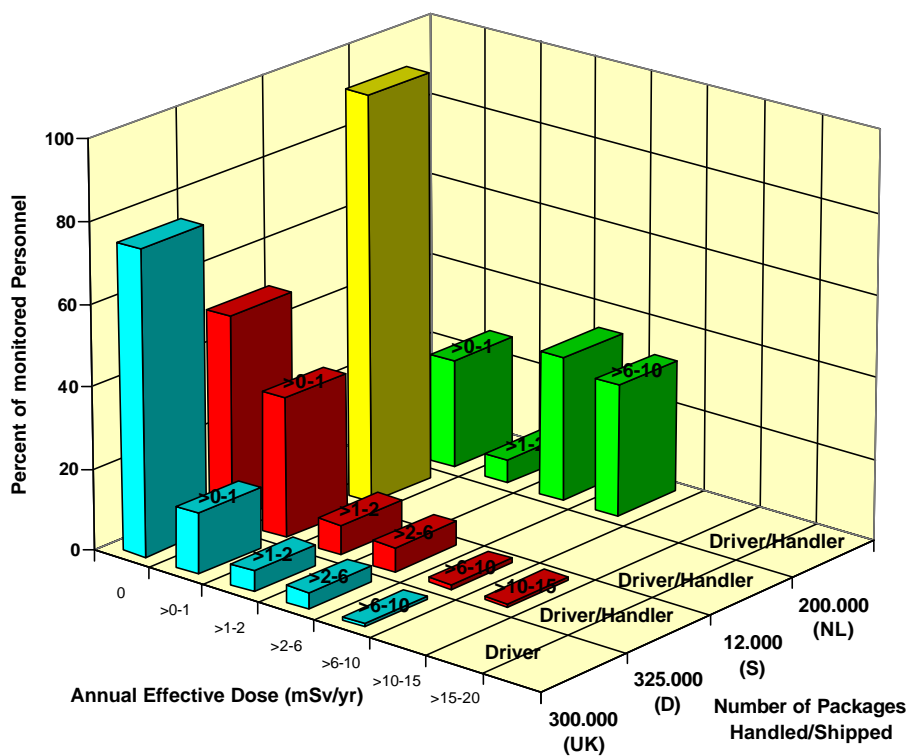

Figure 5: Transport worker doses arising from the transport and distribution of radioisotope package shipments in four EU Member States (Adopted from van Hienen (Ed.) 1999)





ANPA

## **Annex 3**

# **Statistics on the Transport of Radioactive Materials and Statistical Analyses**

(Contribution from Italy)

## **FINAL DRAFT REPORT**

**Work carried out under  
EC Contract No. 4.1020/D/01 – 003 (DG TREN)**

P. Caporali, L. Matteocci, G. Palmieri, S. Trivelloni  
National Agency for Environmental Protection ( ANPA )  
Via V. Brancati, 48 - 00144 Rome – Italy



## TABLE OF CONTENTS

<u>1</u>	<u>Introduction</u> .....	109
<u>2</u>	<u>Background</u> .....	109
<u>3</u>	<u>Data collection</u> .....	109
	<u>3.1 Shipment data</u>	109
	<u>3.2 Definition of "shipment"</u>	111
	<u>3.3 Definition for the study</u>	111
	<u>3.4 Exposure data</u>	112
<u>4</u>	<u>Analyses of data</u> .....	112
	<u>4.1 Shipments ( 1987 – 2000 )</u>	112
	<u>4.1.1 Type and number of operators</u>	112
	<u>4.1.2 Shipping volume</u>	112
	<u>4.1.3 Type of packages shipped</u>	113
	<u>4.1.4 Package characteristics</u>	113
	<u>4.2 Exposures</u>	113
	<u>4.2.1 Radiations exposure to the workers associated with the transport of radioactive material for the period 1996 - 2000</u>	113
<u>5</u>	<u>Analyses of data for calendar year 2000</u> .....	115
	<u>5.1 Shipments</u>	115
	<u>5.2 Exposures</u>	118
	<u>5.2.1 Transport workers exposures</u>	118
	<u>5.2.2 Population exposures</u>	118
<u>6</u>	<u>Discussion</u> .....	120
<u>7</u>	<u>References</u> .....	121

**Tables Index**

<a href="#">Table 1 – Data collected for each shipment</a> .....	110
<a href="#">Table 2 – Transport data ( 1987-2000 )</a> .....	112
<a href="#">Table 3 – Annual effective dose for transport workers (1996 – 2000)</a> .....	114
<a href="#">Table 4 – Annual collective dose and total TI (1996 – 2000)</a> .....	114
<a href="#">Table 5 – Authorized carriers for road transport (2000)</a> .....	115
<a href="#">Table 6 – Number of links and packages for transport mode (2000)</a> .....	116
<a href="#">Table 7 – Link and shipments (2000)</a> .....	116
<a href="#">Table 8 – Number of shipments and packages shipped (2000)</a> .....	116
<a href="#">Table 9 – Data regarding the type of packages and the transport mode (2000)</a> .....	116
<a href="#">Table 10 – Statistics on the radiological characteristics of excepted and Type A packages (2000)</a> .....	117
<a href="#">Table 11 – Activity of the contents in Type A packages in terms of <math>A_2</math> (2000)</a> .....	117
<a href="#">Table 12 – Activity of the contents in Excepted packages in terms of <math>A_2</math> (2000)</a> .....	117
<a href="#">Table 13 – Annual effective dose for transport workers (2000)</a> .....	118
<a href="#">Table 14 – Population exposure from transport of “large sources” in Type B packages</a> .....	119
<a href="#">Table 15 – Population exposure from transport of Type A packages</a> .....	119
<a href="#">Table 16 – Data on the transport of fuel cycle radioactive materials (1987 – 2000)</a> .....	132
<a href="#">Table 17 – Data on the transport of non–fissile radioactive materials (1987 – 2000)</a> .....	133



## Figures

<a href="#">Figure 1 – Different cases of shipment</a> .....	111
<a href="#">Figure 2 – Flow of packages shipped inside and outside Italy</a> .....	115
<a href="#">Figure 3 – Road route for transport of medical sources from producer to Turin Hospitals</a> .....	120
<a href="#">Figure 4 – Authorized carriers in Italy (1987-2000)</a> .....	122
<a href="#">Figure 5 – Shipped volume by road (1987-2000)</a> .....	123
<a href="#">Figure 6 – Package type as % of total of packages shipped (1987-2000)</a> .....	124
<a href="#">Figure 7 – Trend analysis of packages shipped to an Hospital in North Italy (1987-2000)</a> .....	125
<a href="#">Figure 8 – Percentage of shipments as function of type of package (1987-2000)</a> .....	126
<a href="#">Figure 9 – Transport Index distribution as % of Total Links (1987-2000)</a> .....	127
<a href="#">Figure 10 – Category of packages as % of total packages shipped (1987-2000)</a> .....	128
<a href="#">Figure 11 – Total Transport Index (TI) (1987-2000)</a> .....	129
<a href="#">Figure 12 –Contribution of different radionuclides to total Transport Index (2000)</a> .....	130



## 1 Introduction

Data on transport of radioactive material are of great importance to evaluate the performances of the system of protection and safety established by the Transport Regulations. Moreover the knowledge of data on the shipments of radioactive materials can help the competent authority in the periodic assessment of the radiation doses to persons arising from transport activities as required by the IAEA Regulations (par. 304 TS-R-1). The data on transport of radioactive materials and their analyses are also useful for other reasons:

- to support compliance assurance by competent authority;
- to assist competent authority for inspection activities;
- to verify the efficacy of the Regulations that govern the transport of radioactive material;
- to identify trends in transport of radioactive materials;
- to assess, in compliance with applicable Regulations, radiation exposure to people that arise from this practice and to verify that the limits prescribed are respected;
- to provide factual data to help meet public concerns.

The Italian contribution to the report, in line with the objectives of the study financed by the European Commission, regards the analysis of data on shipments of radioactive material performed in Italy during the last decade. The results of a survey on the doses received by the transport workers and an evaluation of doses to the population associated to the transport of radioactive material are also presented.

## 2 Background

Fuel cycle and non-fuel cycle material shipments are the two broad categories that can be taken into account in the analysis of data regarding the transport of radioactive material. Fuel cycle shipments had a big decrease after the result of a referendum held in Italy in 1987 on the use of nuclear power plant for electrical production. After the referendum the transport of nuclear materials regarded only irradiated nuclear fuel shipments to Sellafield (UK) reprocessing plant and shipments related to decommissioning activities. Only few shipments are now performed relative to research reactors activities. An increase of fuel cycle material shipments is foreseen for the next future because of the restarting of transport of irradiated nuclear fuel to Sellafield reprocessing plant. Shipments relative to non-fuel cycle material represent large part of the transport of radioactive materials for research, industrial and medical use.

Data on the shipments of radioactive materials are not easily available in the various countries for different reasons: i.e. absence of binding provisions to collect data or difficulties in collecting and processing of the data due to lack of resources or confidentiality of the data. Some countries that have a binding system are facilitated in collecting data by the operators and can organize a system to manage those data. Other countries that do not have such systems collect data generally by consignors or carriers that provide those data on voluntary basis. In many countries more detailed data are available for shipments regarding the nuclear fuel cycle in virtue of an authorization system generally adopted for such shipments. Italian domestic regulations allow to have available very detailed data on shipments of radioactive material. The radiation protection regulations establish that carriers authorized to transport radioactive materials have to provide to the competent authority, on quarterly basis, data regarding each shipment carried out. Since 1987, by the data available, a database was established containing data on the shipments of radioactive material for all modes of transport.

## 3 Data collection

### Shipment data

Data used for the study have been extracted from the national database that contains the data on the shipments performed by authorised carriers. The data are regularly collected by the carriers and sent to the competent authority on CD Rom or diskette. By ad – hoc procedures the data are checked and stored into the database. The kind of data that are provided by the carriers are detailed in Table 4.



**Table 4 – Data collected for each shipment**

Type of Data	Data	Explanation
Carrier	Identification Code (IC)	Code assigned by the Competent Authority
Shipment	No. of Transport Document	
Consignor	Name	
	Address	
	City	
	Province	
	ZIP code	
Consignee	Name	
	Address	
	City	
	Province	
	ZIP code	
	Identification Code	Identification Code = Fiscal Code
Package	No. of packages	Total number of packages of the shipment
	Dimensions	
	Type	Excepted, IP-1, IP-2, IP-3, A, B
	IAEA Identification mark	
	Category	I-WHITE, II-YELLOW, III-YELLOW
	Transport Index	
Radioactive Material	UN Number	
	Radionuclide	
	Type of source	Solid, Liquid, Gas, Liquid + Solid, Special Form
	Activity	Bq
	Mass	Only for fissile material
Link	Place of start	
	Place of end	
	Previous carrier (IC)	Code assigned by the Competent Authority
	Following carrier (IC)	Code assigned by the Competent Authority
	Date of start	
	Date of end	



## Definition of “shipment”

One of the main problems in data analysis is to define which is the meaning of “shipment”. The ADR and RID Regulations define:

- *shipment* as “the specific movement of a consignment from origin to destination”;
- *consignment* as “any package or packages, or load of dangerous goods, presented by a consignor for carriage”;
- *carriage* as “the change of place of dangerous goods, including stops made necessary by transport conditions and including any period spent by dangerous goods in vehicles made necessary by traffic conditions before, during and after the change of place. This definition also covers the intermediate temporary storage of dangerous goods in order to change the mode or means of transport (trans-shipment). This shall apply provided that transport documents showing the place of dispatch and the place of reception are presented on request and provided that packages are not opened during intermediate storage except to be checked by the competent authorities”.

**Therefore taking into account the definition of “carriage” the shipment of one or more packages can be composed of different “links” and modes of transport.**

For example a package can be transported from a manufacturer (A) to an hospital (B) by three “links” (see Figure 6 case No.3) and two modes of transport (road, air, road). In that case if the shipment is carried out without a specific contract for the carriage, the air carrier may be considered as the “consignee” of the first “link” and the “consignor” of the third link. Therefore for that case we can have three shipments, because each link can be considered as one shipment. In the same case when a contract of carriage exists and the transport document reports the name and address of consignor and consignee we can consider the transport as one shipment. Different cases can be found in practice in which the ambiguity of the definition of shipment can cause confusion for the collection and evaluation of the data. Therefore it is important to define, taking into account the kind of data available, what is intended as “shipment” before the analysis of the data.

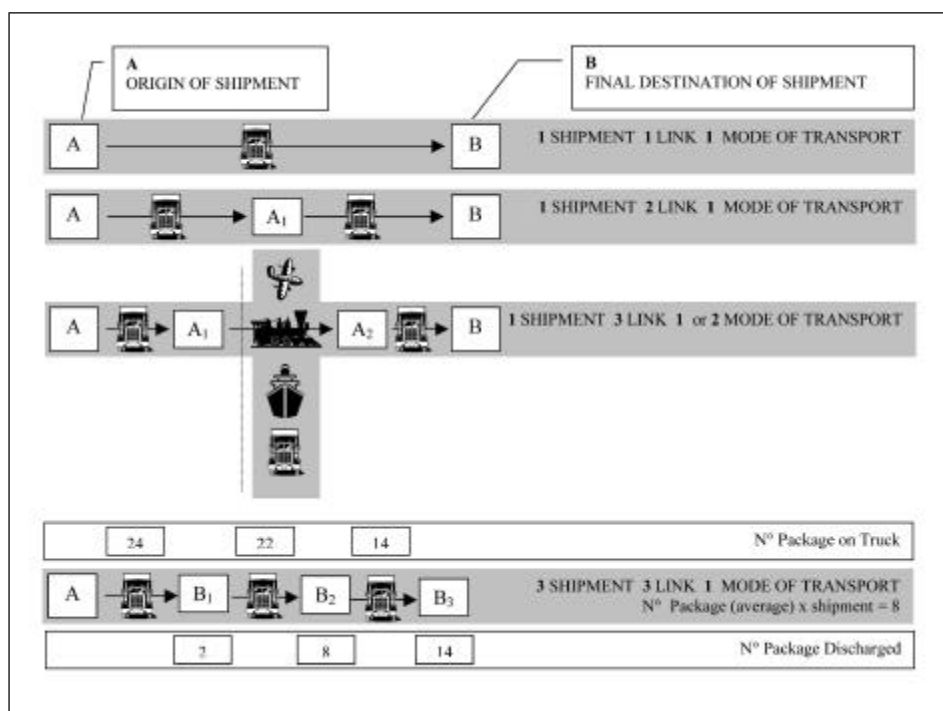

**Figure 6 – Different cases of shipment**

shipment

## Definition for the study

*Shipment:* the specific movement of one or more packages from origin to final destination composed of one or more links and by one or more modes of transport.

*Link:* the specific movement of one or more packages by one means of transport (truck, aircraft, ship or train) and without any intermediate stop.



## Exposure data

Data on radiation exposures to workers were collected by a questionnaire (see Figure 13) that was sent to 75 authorized carriers and operators responsible for the handling of radioactive materials in the main national airports. The questionnaire asked for exposures data during the period 1996 – 2000. 53 (70%) operators including 32 gamma-graphic operators answered to the questionnaire. Evaluations on radiation exposures to the public associated with the transport of radioactive materials were performed by the IAEA INTERTRAN2 computer code. The calculations were based on data of road shipments carried out during the calendar year 2000.

## 4 Analyses of data

### Shipments ( 1987 – 2000 )

The analyses of data are referred to shipments carried out during the period 1987 - 2000 by authorized carriers. The results of the analysis of data are based both on direct elaboration and derived by sampling statistical analyses. Trend analyses have been carried out with the scope to evaluate changes in transport of radioactive materials and to evaluate transport flows from and to abroad and into the national territory. The data regarding the number of shipments and number of packages transported during the period analysed are summarized in Table 5.

**Table 5 – Transport data ( 1987-2000 )**

	1987	1988	1989	1990	1991	1992	1993	1994	1995	1996	1997	1998	1999	2000
No packages	227000	336000	341000	345000	334000	465000	469000	449000	406000	458000	356000	287000	203000	193000
No shipments	61000	81000	78000	92000	83000	90000	148000	144000	134000	155000	134000	118000	99000	86000

Detailed data on shipments of radioactive materials regarding the use both in the nuclear fuel cycle and in medical, research and industrial activities are reported respectively in Table 16 and **Error! Reference source not found.** Table 17.

### Type and number of operators

Shipments of radioactive material are carried out, for all modes of transport, by authorised carriers. The authorisation, issued by the Minister of Productive activities together with the Minister of Infrastructure and Transport, has a validity of seven years and can be renewed on request of the carrier. This authorization is issued on the basis of the technical advice expressed by ANPA. Figure 4 shows the carriers operating in Italy during the period 1987 – 2000 grouped according to the transport mode (the only rail carrier has been considered as road carrier). The number of road carriers has grown in the period 1990 – 1994 after the decision of Italian railways to stop the carriage of small packages of radioactive material. From 1994 to 2000 the number of carriers has decreased in virtue of a merging process among transport undertakings and because some gamma-graphics operators ceased their activity.

### Shipping volume

The number of shipments and packages transported during the period 1987 – 2000 are reported in Figure 4. The maximum number of shipments (155000) was in 1996 with a number of packages transported of 458000. After 1996 the number of shipments and packages transported had a decrease for different causes. This phenomena can be explained taking into account of changes in the production and use of radionuclides particularly in medical field. In medical field has been noted for example: a decrease in the use of radioactive sources, in particular Co-60, for cancer treatment; the increase of the average activity transported for each package with the decrease in the number of packages shipped; the extensive use of Tc99 for medical diagnostic instead of other radionuclides previously used.





## Type of packages shipped

The data regarding the type of packages transported are reported in Figure 6 as percentage of total packages shipped. Figure 7 represents a trend analysis of the number of packages shipped to a hospital located in north Italy in the period 1987 - 2000. This trend analysis is in good agreement with the diagram reported in Figure 5 representing the shipping volume for the same period.

Type A and excepted packages represent the majority of the packages transported. Data of Figure 6 should be analysed taking into account that much more realistic figures in terms of percentage of Type A packages and excepted packages transported are those referred to 1999 and 2000. The packages shipped in these two years were about 55% for Type A packages and 43% for excepted packages. In the previous period it was noted that in many cases the carriers, providing the data, did not distinguish between Type A and excepted packages in the data collection. Type B packages represent only a small percentage of the total packages transported varying from a maximum of 0.6% in 1987 to a minimum of 0.1%. The percentage of Type B packages transported includes shipments of gamma-graphic devices and in many cases they contribute to the total number of shipments as round trip. Industrial packages are a small fraction of the total packages transported varying from a maximum of 5.7% in 1989 to a minimum of 0.4% in 1995. All the data referred to the period 1987 - 2000 confirm that the majority of the packages are transported by road. Air transport is the second mode of transport in terms of packages shipped while only a small percentage of packages are transported by sea.

## Package characteristics

Information on the characteristics of radioactive materials transported in terms of physical state, total activity, kind of radionuclide and other package characteristics that are relevant for the evaluation of doses to the workers and population have been extracted from the database. Radioactive materials, used in particular for radiopharmaceutical delivered to hospitals and to industrial and research establishments, are shipped in large part in Type A and excepted packages as confirmed by the diagram in Figure 8 (range from 90% to 98% of Type A + excepted packages). Radioactive materials shipped are generally in liquid form or solid non special form. The activity of the radioactive material transported in a single package is in the range from a few KBq to a few tens of GBq. The packages used for transport of those radioactive materials are suitable for manual handling by a person and therefore the knowledge of the category and transport index (TI) of the packages allows to evaluate the doses received during transport operations. Figure 9 and Figure 10 report respectively the transport index (TI) and the categories of the packages as percentage of total links and total packages shipped during the period 1987 - 2000. The trend analysis put in evidence an increase in the percentage of packages of category II and III yellow shipped in 1997 - 2000. That increase in transportation of packages of category II and III yellow is also confirmed in Figure 11 that reports the total TI annually transported. The reasons of the increase in the number of packages with categories II and III yellow and the increase of the total TI shipped can be explained with the increase of average activity transported in a single package and the increase in the use of radionuclide with more penetrating radiations, i.e. Tc-99 for medical diagnostic. However in spite of the increase of the average activity in a single package recorded in the period 1997 - 2000 the package activity inventory for excepted packages and Type A packages expressed in units of  $A_2$ , is very low as reported in Table 10 for the year 2000. Data of Tables 11 and 12 confirm that a single excepted package and Type A package generally contain a small fraction of the activity limits, in unit of  $A_2$ , allowed by the Transport Regulations. This element should be taken into account in case of an accident involving excepted packages or Type A packages in virtue of the fact that the radiological consequences of an accident could be more lighter considering that the activity contained into these packages is generally well below the limits established in the Regulations.

## Exposures

### Radiations exposure to the workers associated with the transport of radioactive material for the period 1996 - 2000

The information on transport workers radiation doses have been collected by the carriers and undertakings operating in the main national airports involved in transport and handling of radioactive materials. According to radiation protection regulations workers are classified into two categories taking into account the annual dose limits: category A when the annual dose is greater than 6 mSv/y; category B when the annual dose is in the range 1 - 6 mSv/y. The survey was carried out by a questionnaire (see Figure 13) that was sent to 75 operators including carriers and undertakings responsible for transport and handling of packages. Answers were received from 53 (70%) operators including 32 gamma-graphic operators. Data regarding the gamma-graphics operators were not included in the doses evaluation due to the difficulty for



ANPA

such workers to distinguish between the doses arising from transport of radioactive sources and doses deriving from the gamma-graphic operations. Nevertheless it can be estimated for gamma-graphic operators that only a small percentage of the total annual doses received is related to transport operations including the handling of the packages.

Radiation exposure data of the workers collected for the period 1996 – 2000 are based on a radiation monitoring service adopted for drivers and handlers by the operators. All transport and handling operations are carried out under a radiation protection programme established by the operators. The implementation of operational controls contributes to limit the magnitude of doses to workers and population according to the ALARA principle. Table 3 and Table 4 report the doses arising principally from transport operations associated with radioisotope supply and distribution and with transport of non nuclear waste. The doses arising from transport operations associated with nuclear fuel cycle are negligible due to the very small number of shipments of nuclear materials.

The results of the survey indicate that the occupational average exposure arising from routine transport of radioactive material is generally below of 1 mSv/y for workers. The data are quite homogeneous during all the period examined. For routinely shipments of large number of Type A and excepted packages for transport of radioisotopes, and in particular for the operations at the redistribution centre the occupational exposure can be higher than 1 mSv/y. As reported in Table 3 only in few cases the maximum occupational exposures for single workers have been greater than 6 mSv/y with a maximum of recorded dose of 7.7 mSv/y (1999). Those data confirmed that occupational exposure associated to transport of radioactive materials is well below the limit of 20 mSv/y, established by the radiation protection regulations, for a large part of workers (drivers, handlers).

**Table 6 – Annual effective dose for transport workers (1996 – 2000)**

Year	No. Workers	Annual collective dose man – mSv/y	Average dose mSv/y	Dose	
				min mSv/y	max mSv/y
1996	399	203	0.508	0.024	5.3
1997	445	252	0.567	0.024	4.5
1998	489	341	0.698	0.019	7.2
1999	503	347	0.690	0.024	7.7
2000	456	461	1.011	0.01	5.4

**Table 7 – Annual collective dose and total TI (1996 – 2000)**

Year	Total annual TI	Annual collective dose man – mSv/y	Collective radiation doses per unit TI man – mSv/y
1997	41075	252	0.006
1998	41213	341	0.008
1999	65995	347	0.005
2000	83011	461	0.005



## 5 Analyses of data for calendar year 2000

### Shipments

radionuclides is very limited and the main depots in which radioactive sources for medical and industrial use, imported from abroad, are divided and subsequently dispatched to final destinations are located in the north of Italy.

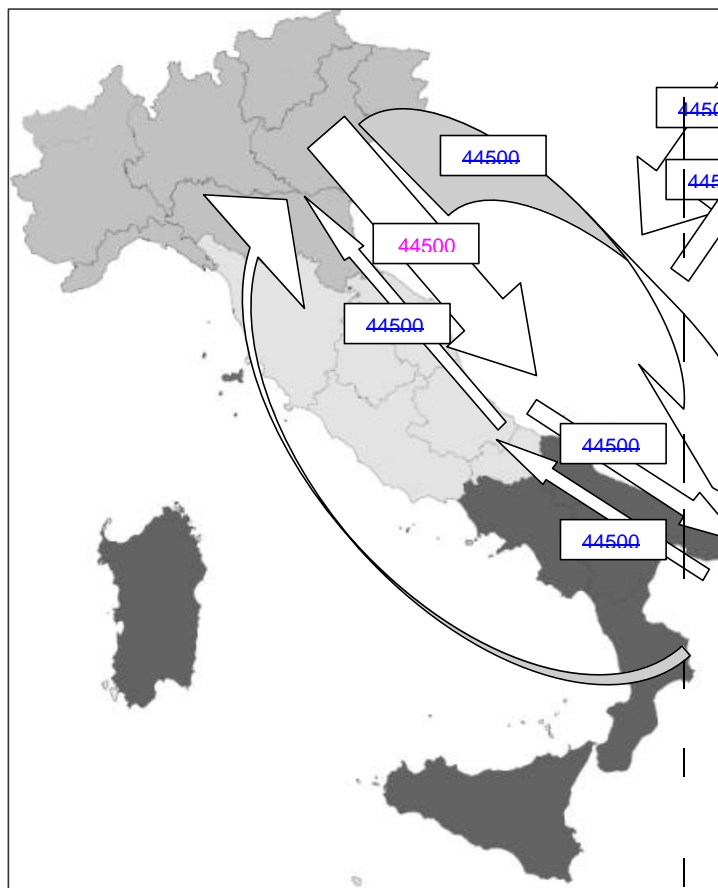

**Figure 7 – Flow of packages shipped inside and outside Italy**

Table 5 reports the number and characteristics of the authorized carriers for road transport operating in Italy in the calendar year 2000.

Table 8 – Authorized carriers for road transport (2000)

Field of use of radioactive material		Carrier on own behalf	Carrier for third party
Medical	Radio-pharmaceutical and diagnostic	1	12
	Medical Waste	2	12
Industrial	γ-graphic operators	68	2
	Industrial waste	6	-
	Measurements	10	-
Nuclear	Fuel cycle and nuclear research	2	7
<b>Total</b>	<b>122</b>	<b>89</b>	<b>33</b>



Tables 6 reports the data on transport of radioactive materials in terms of number of links and number of packages shipped for transport mode; Table 7 reports the number of shipments carried out in the year 2000 and the number of links for the shipments; Table 8 reports the number of shipments performed and the number of different types of package shipped. The data reported in the Tables 6,7 and 8 should be read taking into account of the definitions used for this study reported in 3.3:

*Shipment:* the specific movement of one or more packages from origin to final destination composed of one or more links and by one or more modes of transport.

*Link:* the specific movement of one or more packages by one means of transport (truck, aircraft, ship or train) and without any intermediate stop.

**Table 9 – Number of links and packages for transport mode (2000)**

Mode of transport	Number of links	Number of packages	Number of links %
Road	217000	193000	87
Rail	0	0	0
Air	32000	40000	13
Sea	23	123	0.01

**Table 10 – Link and shipments (2000)**

	Number of shipments	Number of shipments %
One link	71000	84
Three or more links	14000	16

**Table 11 – Number of shipments and packages shipped (2000)**

Type of package	Number of shipments	Number of packages	Number of shipments %	Number of packages %
Type B	2445	440	2.8	0.2
Type A	31431	109037	36.6	56.4
Industrial package	278	1094	0.3	0.6
Excepted package	51651	82804	60.2	42.8

The data shown that Type A packages (56.4%) and excepted packages (42.8 %) are most often transported. Type B packages represent only 0.2% and are related in large part to round trip of radiographic devices for non destructive tests.

**Table 12 – Data regarding the type of packages and the transport mode (2000)**



Mode of transport \ Type of package	Type B	Type A	Industrial package (IP-1, IP-2, IP-3)	Excepted package	Total
Road	440	109037	1094	82804	193000
Rail	0	0	0	0	0
Air	42	28378	21	11332	40000
Sea	18	104	1	0	123

Air transport is the second mode of transport in terms of packages shipped (21%) while only a small percentage of packages are transported by sea

**Table 13 – Statistics on the radiological characteristics of excepted and Type A packages (2000)**

Package characteristic	Package Type	
	Excepted	Type A
Average package activity inventory (GBq)	0.13	14
Average Transport Index (TI)	n.a.	0.5

Table 11 reports the percentage of Type A packages that carry an activity in the range from 1 to 10E-6 of A<sub>2</sub> and less than 10E-6 A<sub>2</sub>.

**Table 14 – Activity of the contents in Type A packages in terms of A<sub>2</sub> (2000)**

Activity	% of Packages
from 1 to 1/10 of A <sub>2</sub>	11
from 1/10 to 1/1000 of A <sub>2</sub>	24
from 1/1000 to 1/100000 of A <sub>2</sub>	41
from 1/100000 to 1/1000000 of A <sub>2</sub>	4
< 1000000 of A <sub>2</sub>	20

Table 12 reports the percentage of excepted packages that carry an activity in the range from 10E-3 to 10E-6 of A<sub>2</sub> and less than 10E-6

**Table 15 – Activity of the contents in Excepted packages in terms of A<sub>2</sub> (2000)**

Activity	% of Packages
from 1/1000 to 1/100000 of A <sub>2</sub>	19
from 1/100000 to 1/1000000 of A <sub>2</sub>	16
< 1000000 of A <sub>2</sub>	65

Data of Tables 11 and 12 put in evidence that the activity contained in a single Type A and excepted package is a very small fraction of Type A package non – special form contents limit (A<sub>2</sub>) indicated in the Transport Regulations.



## Exposures

### Transport workers exposures

Data on transport workers radiation doses, related to calendar year 2000, have been collected by a questionnaire (see Figure 13) sent to carriers and other operators as described in 4.2.1. Those data are based on a radiation monitoring program applied by the operators with a total work force of 456 monitored individuals. The radiation exposures of workers involved in transport of radioactive materials for medical, scientific and industrial activities for the year 2000 are reported in Table 16.

**Table 16 – Annual effective dose for transport workers (2000)**

No. workers	Annual collective dose man-mSv/yr	Average dose mSv/yr	Dose min – max mSv/yr	Total TI	Collective radiation doses per unit TI man-mSv/yr
456	461	1.011	0.01 – 5.4	83011	0.005

The data demonstrate that the annual doses for a large part of transport workers are below 6 mSv/yr. The annual collective radiation dose of 461 man-mSv/yr corresponds to a total Transport Index (TI) of about 83011 and is referred to the volume of radioactive material transported in large part by Type A packages. A TI normalised collective radiation doses for transport workers of 0.005 man-mSv/yr has been determined taking into account that the contribution of excepted packages to the transport workers dose is negligible.

### Population exposures

The evaluation of doses to the public arising from routine (incident free) transport of radioactive material is possible only by calculation considering the impracticability of radiation dose monitoring of individual members of the population. Two different calculations have been performed, by INTERTRAN2 IAEA computer code, to evaluate collective radiation doses to the public arising from transport of Type B and Type A packages with radioactive materials for medical and industrial use. All the data requested by the code regarding the TI per package or vehicle, characteristics and activity of the contents, package dimensions, distances travelled, number of stops are referred to shipments of “large sources” carried out by Type B packages and sources for medical use shipped by Type A packages. An amount of radioactive material is defined as “large source”, by the domestic regulations, when the activity in a Type B package is greater than 30 A<sub>1</sub> for special form radioactive material or 30 A<sub>2</sub> for non special form radioactive material. Domestic transport regulations require an ad-hoc authorization for shipments of these “large sources”, issued by the competent authority.



ANPA

Collective and individual doses associated to road shipments of "large sources" of Cobalt 60 in Type B packages for medical and industrial use for calendar year 2000

**Table 17 – Population exposure from transport of "large sources" in Type B packages**

	No. shipments	Activity min - max TBq	Total activity TBq	TI min - max	Total TI	Total distance travelled km	Individual dose $\mu\text{Sv/yr}$	Collective dose person –mSv/yr
Medical source	17	12 - 220	1503	0 - 2	10.1	5761	0.004	0.43
Industrial source	4	41 - 13300	18586	0.5 - 8	11.5	1290	0.002	0.42

Collective and individual doses associated to road shipments of non special form sources of Iodine 125 for medical use in Type A packages for calendar year 2000

The shipments were regularly performed during the calendar year 2000 from SORIN depot to Turin hospitals (see Figure 3). It was assumed that an average of 14 packages were carried in a commercial van travelling for a distance of 52 km per each shipment.

**Table 18 – Population exposure from transport of Type A packages**

	No. shipments	No. packages	TI package	TI vehicle	Total TI	Total distance travelled km	Individual dose $\mu\text{Sv/yr}$	Collective dose person –mSv/yr
Medical source	244	3420	0.2	2.8	789	12450	1.2	219



Calculations of individual and collective doses to the population arising from transport of radioactive material confirm that the doses to the public are well below the regulatory dose limit of 1 mSv/yr. Moreover the results put in evidence that the highest contribution of the doses to the public is due to the transport and distribution of large quantities of radioisotopes for medical, scientific and industrial applications.



**Figure 8 – Road route for transport of medical sources from producer to Turin Hospitals**

## 6 Discussion

An extensive analysis of the data regarding the shipments of radioactive material has been performed for the period 1987 – 2000. The trend analysis put in evidence the increase from 1987 to 1996 of the number of shipments performed and of the number of packages transported and a decrease in the period 1997 – 2000. This general trend has been confirmed by the analysis performed on the number of packages ( Type A and excepted packages ) shipped in the same period to an hospital in north Italy.

A general increase in the number of packages of category II – yellow and III – yellow, associated to the increase of total annual Transport Index, has been recorded for the period 1996 – 2000. Those increases can be ascribed to an higher value of the average activity transported in a single package and to the increase in transport of technetium generators.

Data on radiation exposures to workers have been collected by a questionnaire for the period 1996 – 2000. The annually received average dose is in most cases less than 1 mSv/y and in few cases in the region of 1 – 8 mSv/y.

Exposures to the public have been estimated by calculation with INTERTRAN2 computer code analysing shipments of radioactive material for industrial and medical use. The elaborations confirm that most part of public exposures arising from transport of radioactive material for medical use with a value estimated of an annual maximum effective dose of 1.2  $\mu$ Sv/y.





## 7 References

- [1] International Atomic Energy Agency (IAEA) – Regulations for the Safe Transport of Radioactive Material – Safety Standards Series 1996 Edition (Revised) No. TS-R-1 (ST-1 Revised)
- [2] International Atomic Energy Agency (IAEA) – International Basic Safety Standards for the Protection against Ionising Radiation and for the Safety of Radiation Sources, Safety Series No. 115, IAEA, Vienna, 1996
- [3] Council Directive 96/29/Euratom of 13 May 1996 laying down basic safety for the protection of the health of workers and general public against the danger arising from ionising radiation
- [4] Lange, F. et al., The evaluation of the situation in the European Community (EC) as regards safety in the transport of radioactive material and the prospects for the development of such type of transport ( EC Research Contract No. 4.1020/D/97-003, DG XVII), February 1999
- [5] Palmieri, G. – Trivelloni, S. , TRARAD: The Italian database on the shipments of radioactive material, RAMTRANS - Vol. 10, No.1, pp. 31-36 (1999), Nuclear Technology Publishing
- [6] AMC Konsult AB, INTERTRAN2, Transportation Risk Assessment Package



ANPA

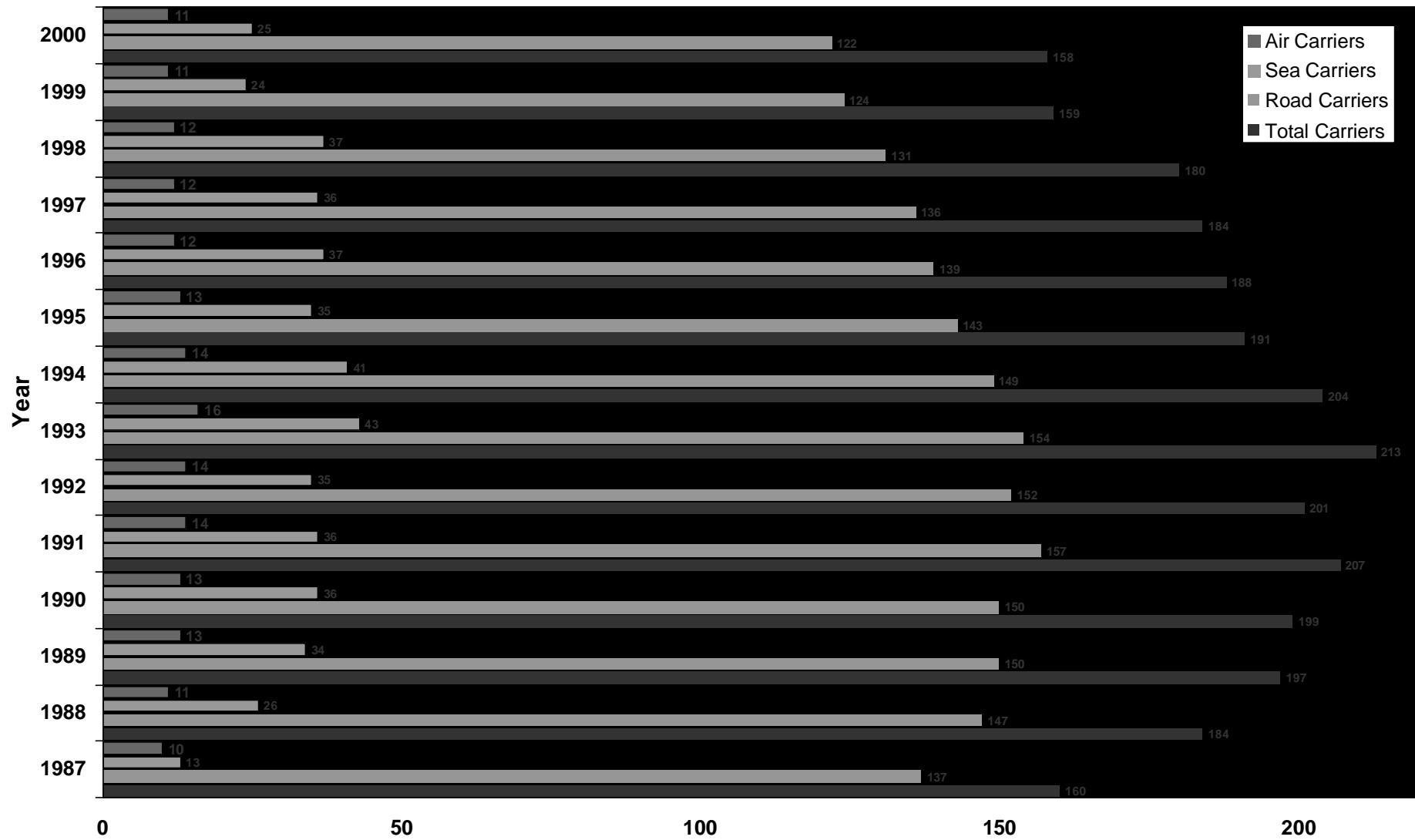

Figure 9 – Authorised carriers in Italy (1987-2000)

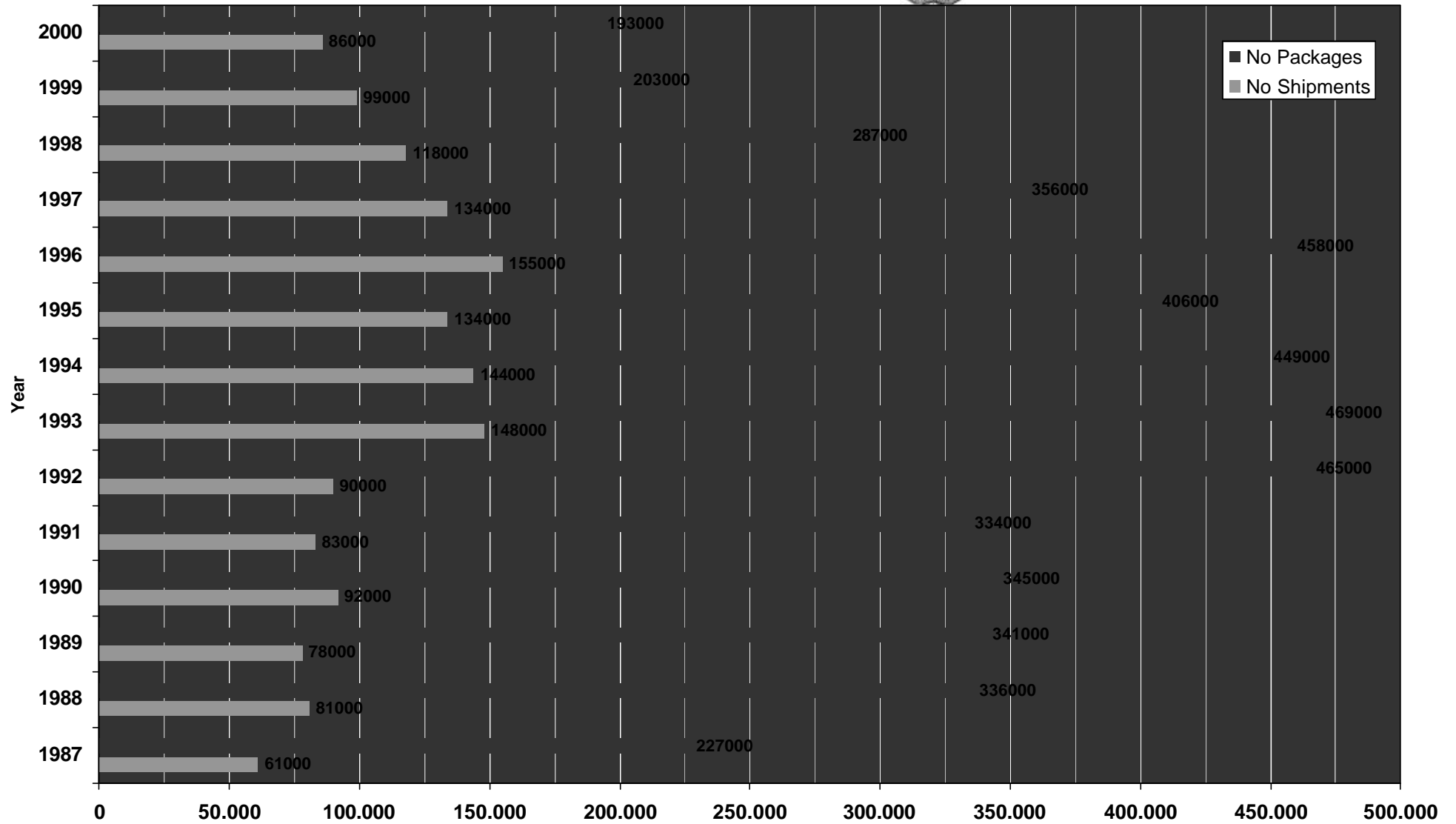

Figure 10 – Shipped volume (1987-2000)



ANPA

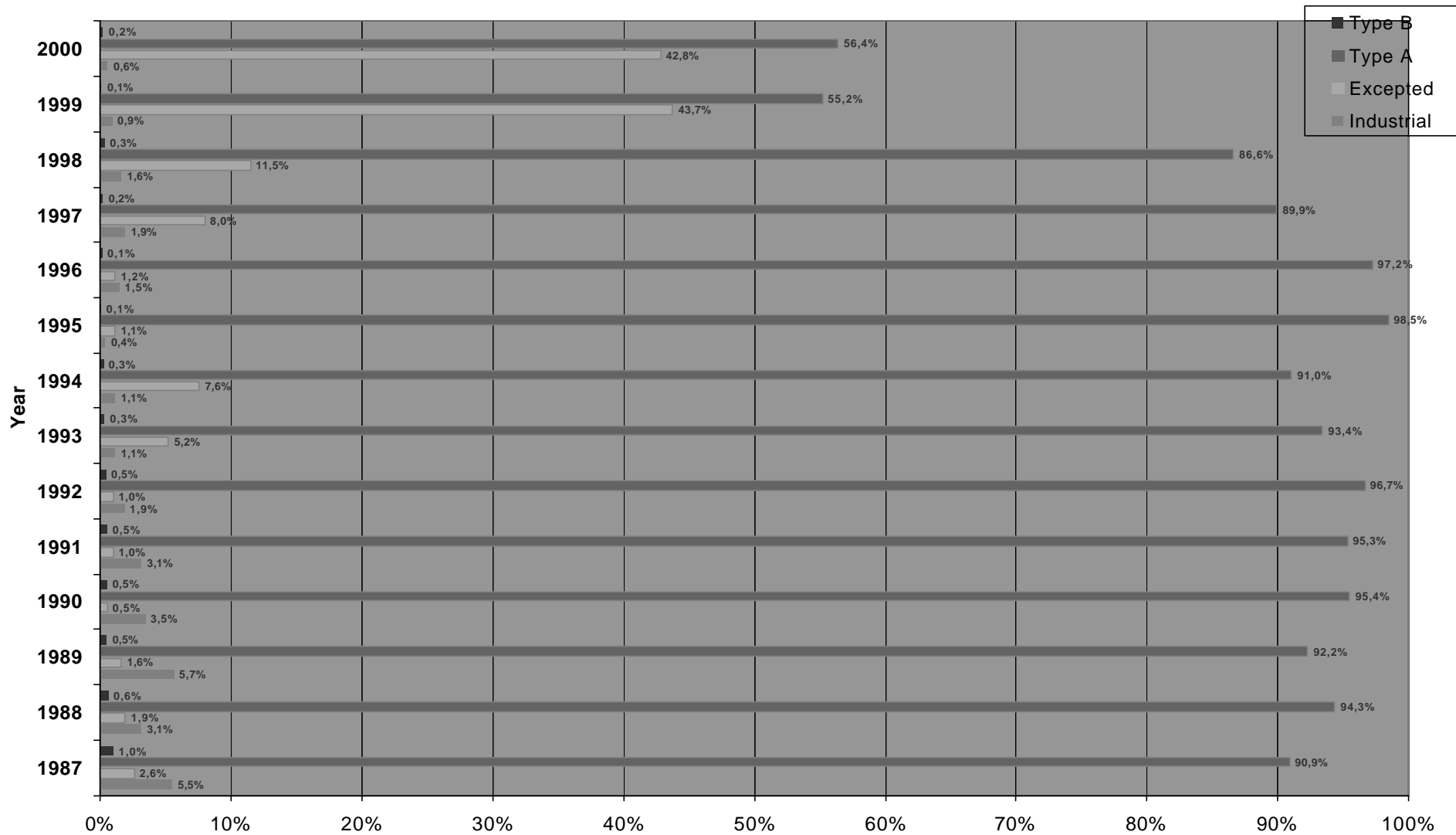

Figure 11 – Package type as % of total packages shipped (1987-2000)



ANPA

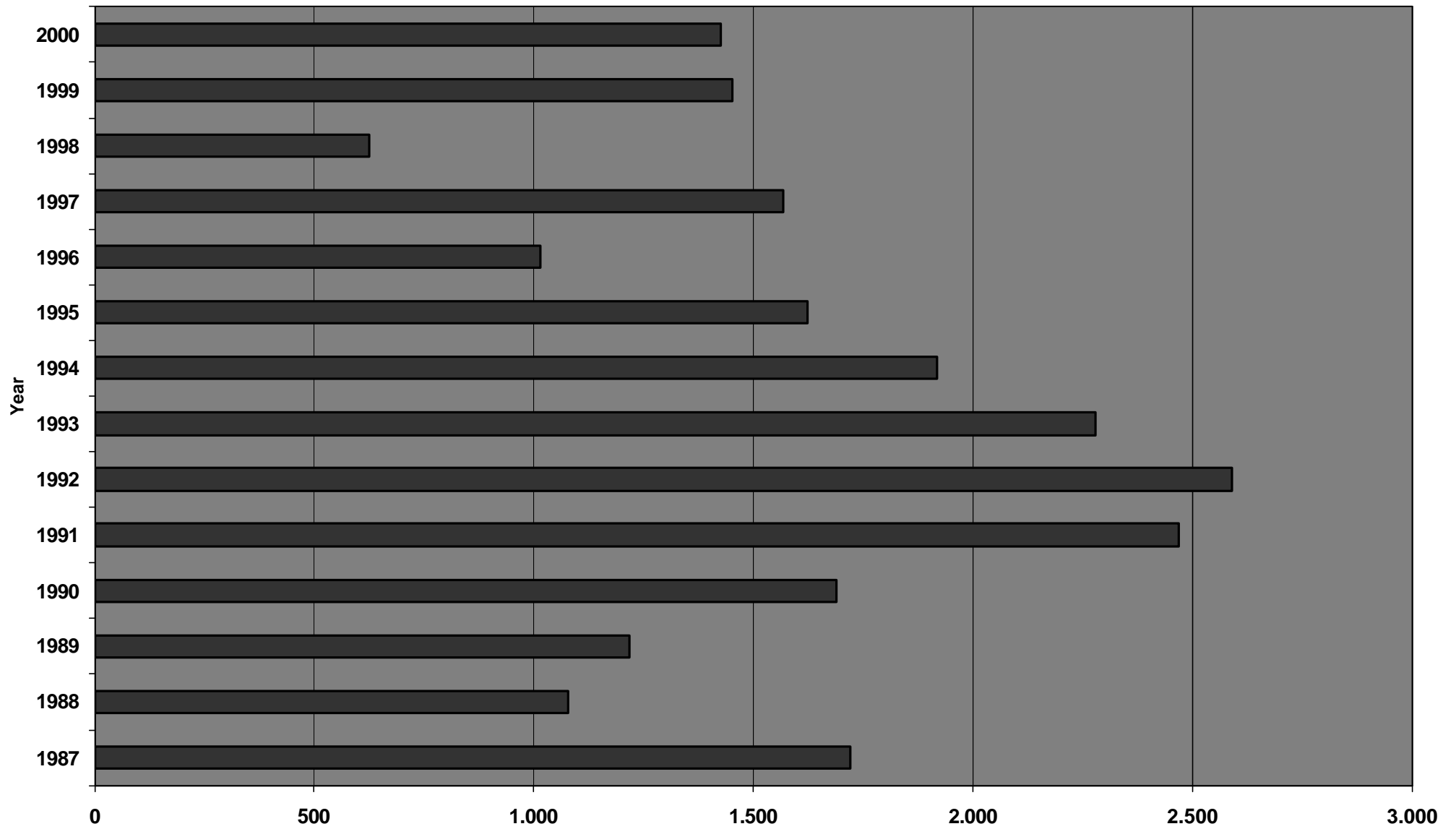

Figure 12 – Trend analysis of packages shipped to an Hospital in North Italy (1987-2000)

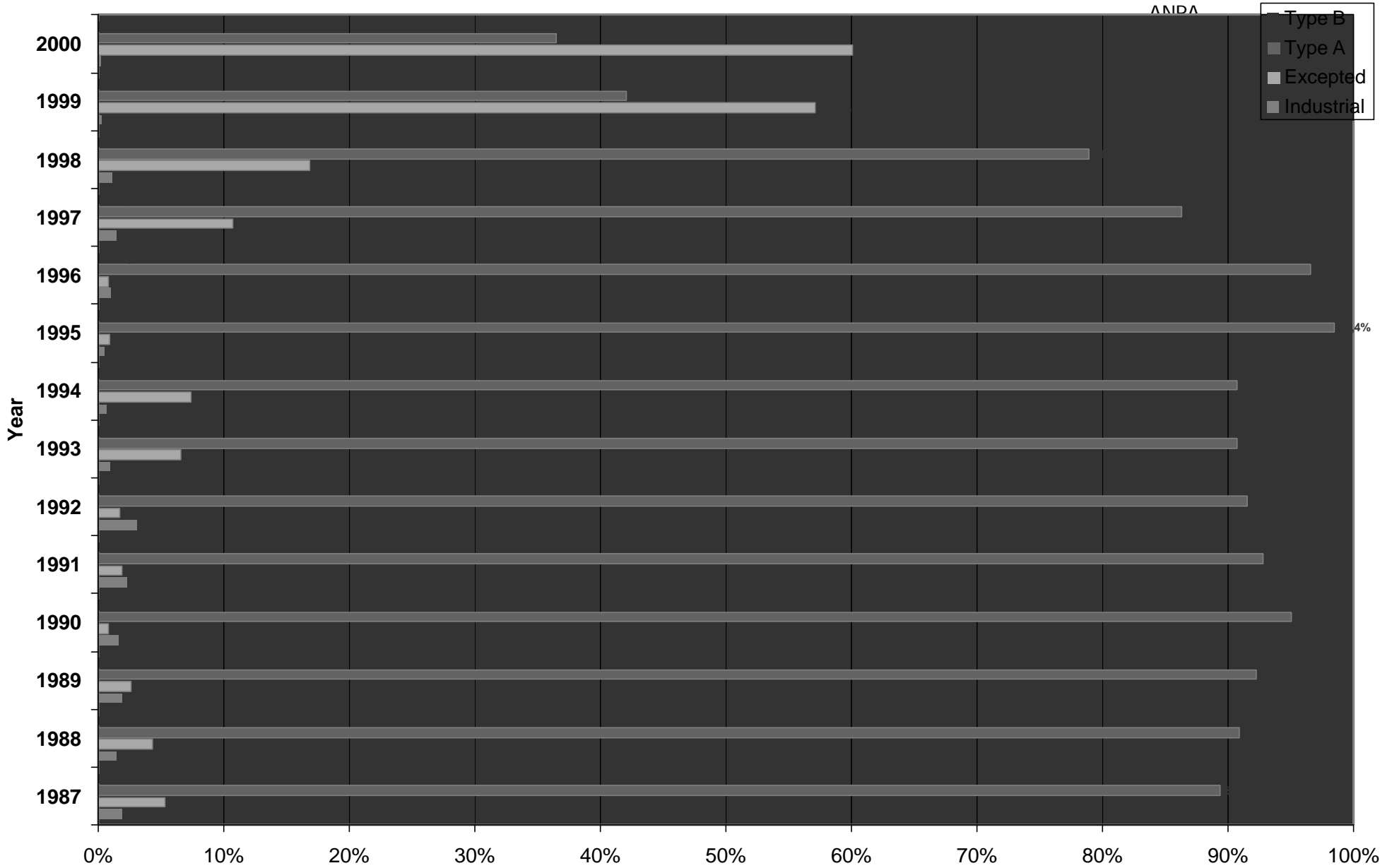

Figure 13 – Percentage of shipments as function of package type (1987-2000)



ANPA

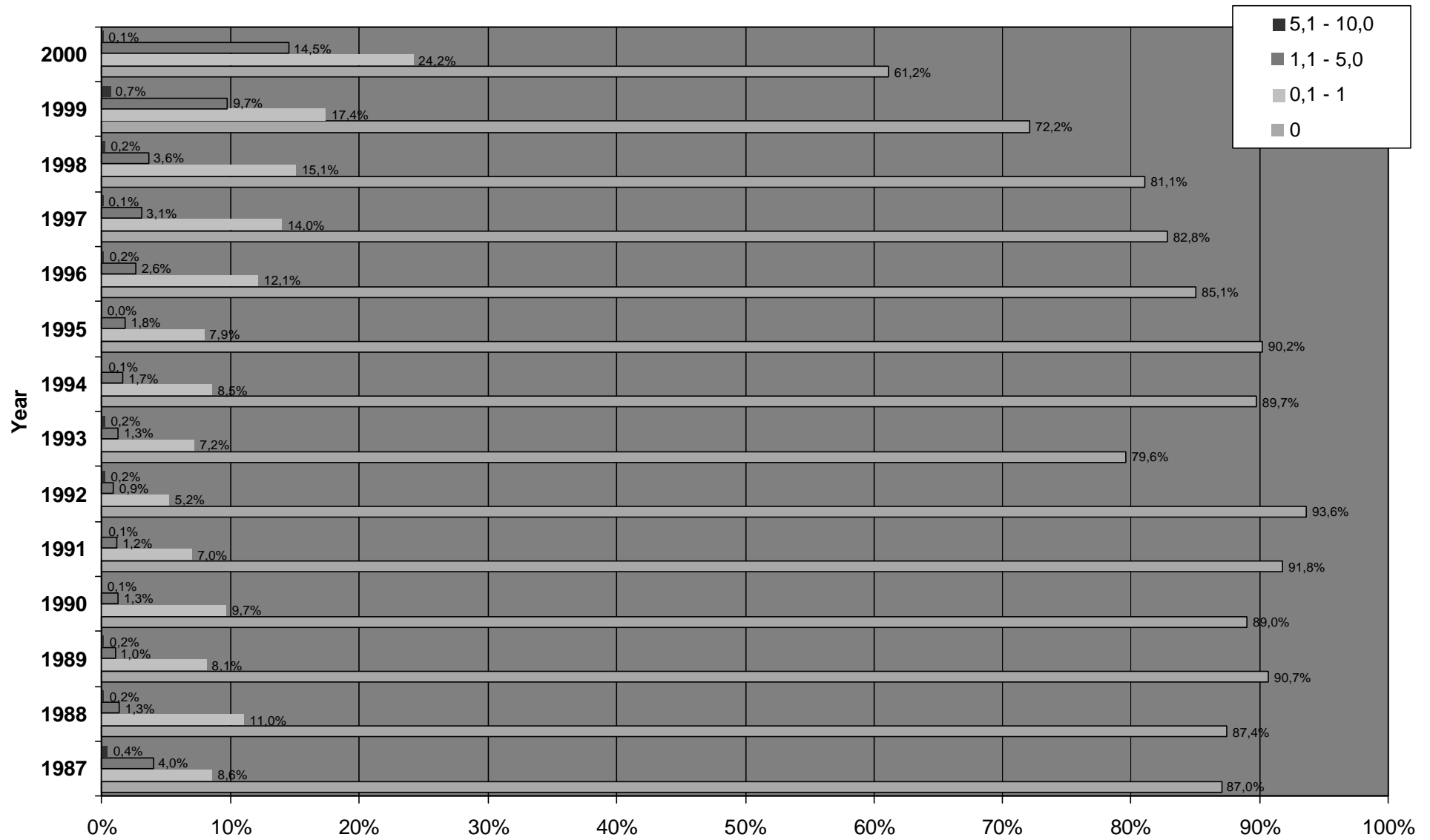

Figure 14 – Transport Index distribution as % of total links (1987-2000)

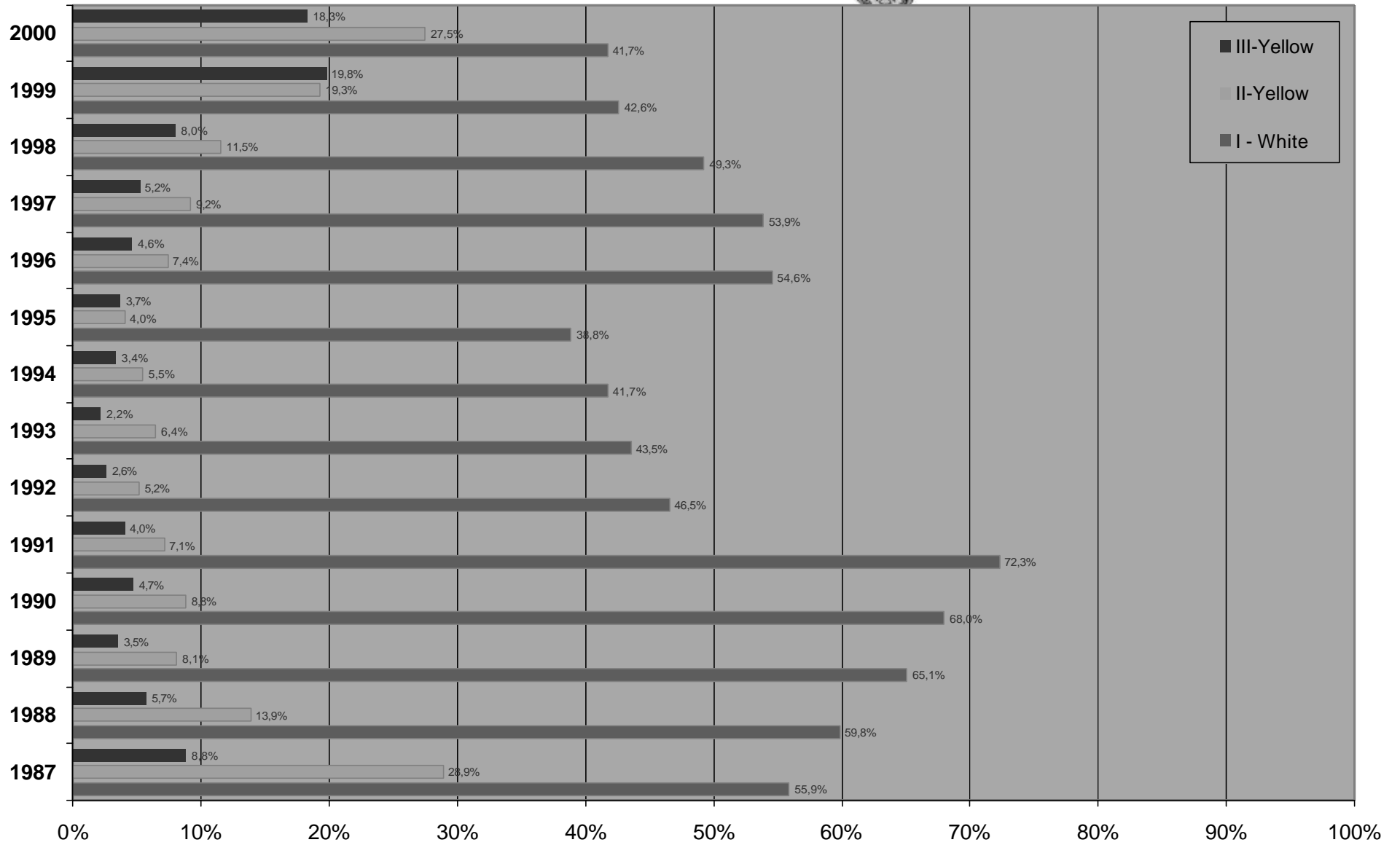

Figure 15 – Category of packages as % of total packages shipped (1987-2000)





ANPA

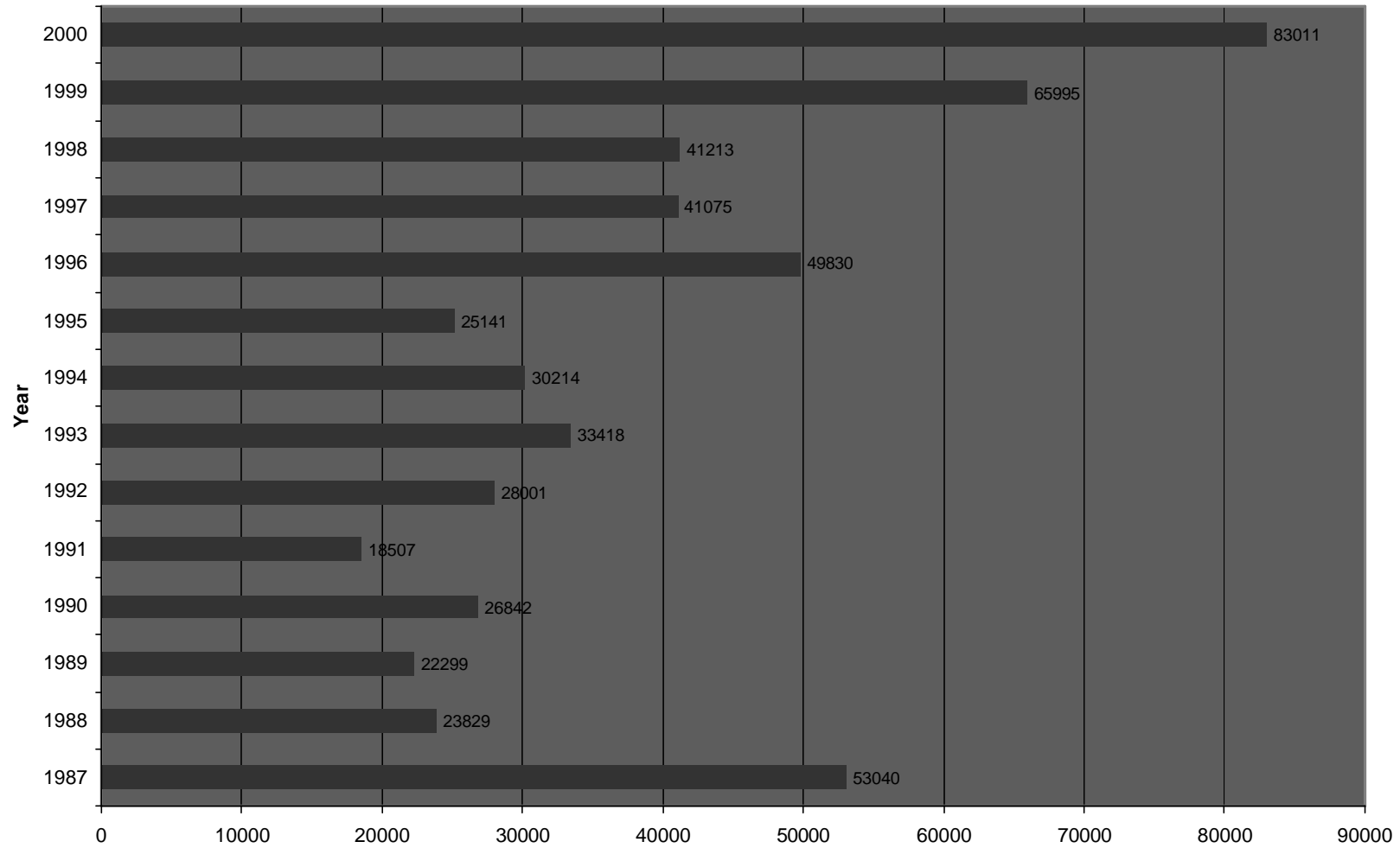

Figure 16 – Total Transport Index (TI) (1987-2000)



ANPA

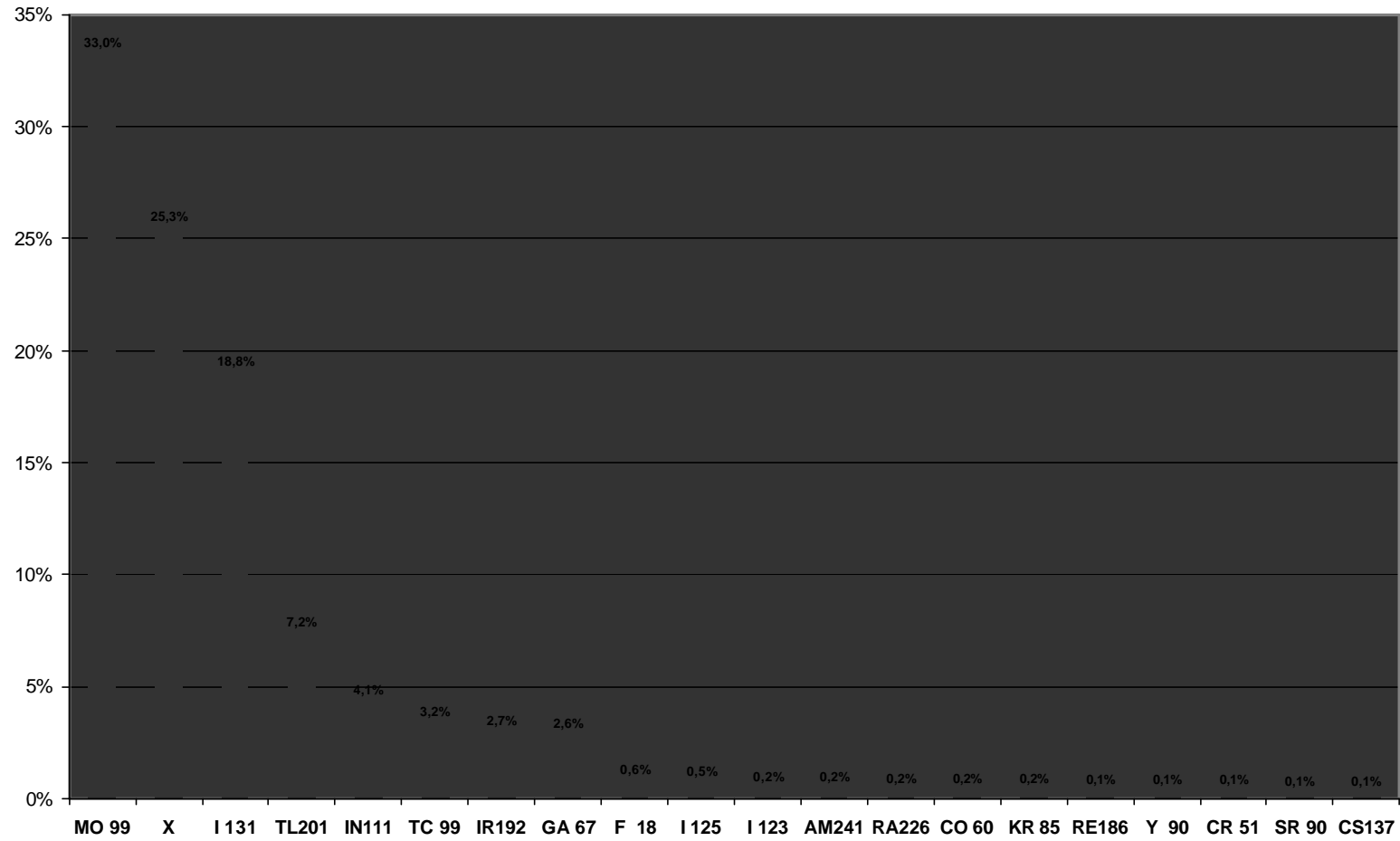

Figure 17 –Contribution of different radionuclides to total Transport Index (2000)



ANPA

*X : Mixture of Radionuclides*



**Table 19 – Data on the transport of fuel cycle radioactive materials (1987 – 2000)**

		Irradiated fuel assemblies, fuel pins (UO <sub>2</sub> , MOX)	Non-irradiated fuel assemblies, fuel pins (UO <sub>2</sub> , MOX)	Uranium/Thorium ore	Pre-fuel material (UOC, U308, UO <sub>2</sub> , MOX, pellets)	Uranium hexafluoride	Vitrified radioactive waste	Low/intermediate-level radioactive waste (LLW/ILW)	Unloaded (empty) flasks	Other (samples, components, monitoring equipment etc)
<b>1987</b>	NoS	49	6	4	30			3		36
	NoP	126	28	1000	3348			3		804
<b>1988</b>	NoS	16			2			1		
	NoP	16			14			22		
<b>1989</b>	NoS	26			9					
	NoP	26			465					
<b>1990</b>	NoS	48		1	7					3
	NoP	79		10	270					3
<b>1991</b>	NoS	37			2	1				1
	NoP	37			119	38				3
<b>1992</b>	NoS	1			4					5
	NoP	1			29					21
<b>1993</b>	NoS				1					1
	NoP				5					6
<b>1994</b>	NoS	1				1				15
	NoP	1				6				29
<b>1995</b>	NoS	1								3
	NoP	1								28
<b>1996</b>	NoS	2								
	NoP	2								
<b>1997</b>	NoS	4	1	1						1
	NoP	4	60	8						1
<b>1998</b>	NoS		1							12
	NoP		2							48
<b>1999</b>	NoS	1	3		1					3
	NoP	1	77		3					3
<b>2000</b>	NoS	1	1							2
	NoP	1	108							2

NoP Number of Packages    NoS Number of Shipments



ANPA

**Table 17 – Data on the transport of non-fissile radioactive materials (1987 – 2000)**

		1987	1988	1989	1990	1991	1992	1993	1994	1995	1996	1997	1998	1999	2000
<b>Radioisotope Supply and Distribution</b>															
	NoS	1910	2457	2199	2058	2242	2700	2539	1741	244	2198	1685	3253	460	2425
Type B packages	NoP	1473	2090	1656	1886	1765	2157	1438	1129	248	647	690	990	223	440
	NoS	54910	73787	72539	87915	77146	82571	134838	131050	132346	149713	115657	93206	41818	31431
Type A packages	NoP	206984	316935	314599	328827	318000	449717	437584	408962	399666	445866	320133	248808	112079	109037
	NoS	3312	3509	2061	818	1574	1622	9764	10695	1211	1380	14472	19957	56682	51651
Excepted packages	NoP	5994	6445	5504	1820	3381	4695	24329	33957	4568	5309	28470	32900	88792	82804
	NoS	1187	1188	1494	1536	1882	2817	1387	907	634	1641	2017	1361	291	278
Industrial package	NoP	12473	10457	19270	11976	10367	8629	5296	5154	1463	6663	6734	4601	1874	1094
<b>Radiation Sources</b>															
	NoS	1462	1759	1772	1648	1830	2335	2339	1629	128	2100	1528	2454	350	2290
Radiographic	NoP	800	784	815	731	820	1328	803	752	98	517	472	705	116	355
	NoS	630	630	630	630	688	651	412	407	93	393	278	308	307	380
Nuclear density/gauge devices	NoP	650	650	650	650	746	772	525	485	103	758	331	323	436	441
<b>Radioactive Wastes</b>															
	NoS	18773	18773	18773	18773	19170	16342	14793	16187	11817	17897	16233	14223	13331	11893
Medical /Research	NoP	36419	36419	36419	36419	31075	26603	22756	23237	15621	26963	24278	22172	18787	16394
	NoS	346	346	346	346	529	507	475	450	783	493	543	648	557	1254
Industrial	NoP	3150	3150	3150	3150	903	1232	874	911	1758	1003	925	1421	786	1828
<b>Consumer Products</b>															
	NoS	610	610	610	610	565	907	635	767	973	1112	865	943	232	253
Smoke detectors	NoP	1317	1317	1317	1317	1392	2336	1697	2286	3454	3892	3682	2694	657	318
	NoS	99	99	99	99	134	133	160	122	147	202	105	461	126	341
Lighting products	NoP	4207	4207	4207	4207	7534	8313	9233	7542	392	469	483	26116	548	548
<b>TOTAL (rounded)</b>															
	NoS	61000	81000	78000	92000	83000	90000	148000	144000	134000	155000	134000	118000	99000	86000
	NoP	227000	336000	341000	345000	334000	465000	469000	449000	406000	458000	356000	287000	203000	193000

Undertaking :

NoP Number of Packages  
NoS Number of Shipments



ANPA

Location: \_\_\_\_\_

- Activity:
- ▲ Transport of radioactive material only
  - ▲ Transport and use of radioactive material
  - ▲ Collecting and transport of radioactive material
  - ▲ Loading and unloading and in transit storage
  - ▲ Others \_\_\_\_\_

Exposure data should be reported for classified workers ( A and B category ) and for non classified workers

Reporting year	No. of classified workers	Annual effective Dose mSv/y	Effective Dose (min / max) mSv/y	Non classified workers	
				No.	Effective Dose mSv/y
1996					
1997					
1998					
1999					
2000					

Figure 13 - Questionnaire form used to collect transport-related exposure data



ANPA

**Survey on the Type and Magnitude of Radioactive Material Shipments in the Public Domain of EU Member States and Applicant Countries: Part I**

Reporting Country: .....**ITALY**.....  
 Reporting Year: .....**2000**.....

Radioactive Material	Annual transport volume		Predominant transport mode			
	Number of Shipments per Year	Number of Packages per Year	Road	Rail	Air	Sea
<b>Fuel Cycle Material:</b>						
- Irradiated fuel assemblies, fuel pins (UO <sub>2</sub> , MOX)	1	1	√			
- Non-irradiated fuel assemblies, fuel pins (UO <sub>2</sub> , MOX)	1	108	√			
- Uranium/thorium ore						
- Pre-fuel material (UOC, U <sub>3</sub> O <sub>8</sub> , UO <sub>2</sub> , MOX, pellets etc.)						
- Uranium Hexafluoride (UF <sub>6</sub> )						
- Vitrified radioactive waste						
- Low-/intermediate-level radioactive waste (LLW/ILW)						
- Unloaded (empty) flasks						
- Others (samples, components, monitoring equipment etc.)	2	2	√			
<b>Radioisotope Supply and Distribution:</b>						
- Type B packages	2425	440	√			
- Type A packages	31431	109037	√		√	
- Excepted packages	51651	82804				
- Others	278	1094	√			



ANPA

**Survey on the Type and Magnitude of Radioactive Material Shipments in the Public Domain of EU Member States and Applicant Countries: Part I (Continued)**

Radioactive Material	Annual transport volume		Predominant transport mode			
	Number of Shipments per Year	Number of Packages per Year	Road	Rail	Air	Sea
<b><u>Radiation Sources:</u></b>						
- Radiographic radiation sources	2290	355	√			
- Nuclear density/portable gauging devices	380	441	√			
- Others						
<b><u>Non-nuclear Radioactive Wastes</u></b>						
- Medical / research wastes	11893	16394	√			
- Industrial wastes	1254	1828	√			
- Others (specify)						
<b><u>Consumer Products</u></b>						
- Smoke detectors	253	318	√			
- Radioluminescent products						
- Lighting products						
- Others (specify)	341	548	√			





ANPA

**Survey of Occupational and Public Radiation Exposures arising from Radioactive Material Package Shipments in EU Member States and Applicant Countries: Part II**

Reporting Country: .....ITALY.....

Reporting Year: .....2000.....

Transport Operations	Annual effective Dose				Remarks
	Transport Workers (mSv/y)		Public (Critical group) (mSv/y)		
	Avg.	min./max.	Avg.	min./max.	
<b><u>Nuclear Fuel Cycle</u></b>					
- Road					
- Rail					
- Air					
- Sea					
<b><u>Radioisotope Supply and Distribution</u></b>					
- Road	1.011	0.01 / 5.4		0.002 / 1.2	
- Rail					
- Air					
<b><u>Radiation Sources</u></b>					
- Radiography					
- Nuclear density/gauging devices					
<b><u>Non-nuclear Wastes</u></b>					
- Medical/research/industry (specify)					
<b><u>Consumer Products</u></b>					
Road/Rail/Air/Sea (specify)					
	If available give additional details, references etc. under remarks or on a separate page				



**Annex 4**

**Statistics on the Transport of Radioactive Materials**

**and Statistical Analyses**

(Contribution from the Netherlands)

**Final Report**

**Work performed under**

**EC Contract No. 4.1020/D/01-003**

J.F.A. van Hienen, R. Jansma

NRG

Westerduinweg 3, P.O. Box 25, NL-1755 ZG Petten, The Netherlands

December 2002

Statistics on the Transport of Radioactive Materials and Statistical Analyses  
(*Contribution from the Netherlands*)

J.F.A. van Hienen  
R. Jansma

Petten, 14 February 2003

20887/03.52056/C

Work performed under contract No: 4.1020/D/01-003 of the European Commission

FINAL REPORT

---

Author : J.F.A. van Hienen  
R. Jansma

Reviewed : F. van Gemert

---

50 page(s)

Approved : R. Huiskamp

nrg52056jvh-rev220203

---

## Preface and acknowledgements

The work presented in this document is part of an international study project 'Statistics on the Transport of Radioactive Materials and Statistical Analyses', performed by institutes of five EU Member States under contract number 4.1020/D/01-003 of the European Commission DG-TREN.

The contractors involved are NRPB Chilton UK (Project co-ordinator), GRS Cologne Germany, ANPA Rome Italy, NRG Petten Netherlands, IRSN Fontenay-aux-Roses France and CEPN Fontenay-aux-Roses France.

The authors gratefully acknowledge the information and advice provided by:

TYCO Healthcare;

Amersham Health BV;

GKN (Dodewaard NPP);

EPZ (Borssele NPP);

COVRA N.V.,

and the support by the Ministry of Economical Affairs of the Netherlands.

## Distribution

NRPB (project co-ordinator)

GRS

ANPA

IRSN

CEPN

NRG

## Abstract

Recent shipment data and exposure data on transportation of radioactive material in the Netherlands have been collected and analysed as part of an international study project. This project 'Statistics on the Transport of Radioactive Materials and Statistical Analyses' was performed in 2002 by institutes of five EU Member States under Contract No. 4.1020/D/01-003 of the European Commission DG-TREN.

The present report on data from the Netherlands is part of the final study report to DG-TREN, which was prepared by the contractors and co-ordinated by the NRPB.

Shipment data are collected for frequent transportation of radioactive material in the Netherlands, during the year 2001, which include the following transport operations:

- Shipments of flasks with irradiated fuel elements from NPP Borssele, NPP Dodewaard and the research reactor HFR at Petten;
- Shipments of intermediate- and low-level radioactive waste to the storage facility of the national organisation for radioactive waste COVRA;
- Shipments of radioisotopes in use for medical, scientific and general industrial applications (for two consignors);
- UF<sub>6</sub> shipments to and from Urenco, Almelo.

The collected data show that most of the shipments in the Netherlands (> 95%) are shipments of radioisotopes for medical applications. The total number of these shipments has not been changed much during the last years.

From the recorded doses of workers involved in transport operations it may be concluded that individual annual doses are less than 10 mSv, during recent years. The highest annual doses received by transport workers are the doses of handlers involved in the preparation of shipments of radiopharmaceuticals. It has been observed that the collective doses of these handlers are decreasing due to operational and technical measures. The average collective dose per TI handled has been reduced from 1 man-microSv/TI (1998) to 0,5 man-microSv/TI (2002).

Dose reductions have also been found for the group of workers involved in the preparation of shipments of irradiated fuel, although presently the monitoring and cleaning operations are more extensive than before 1997, the year in which these shipments were banned.

Exposures of members of the critical groups of the population have been assessed from model-calculations based on actual situations and traffic statistics. Theoretically, the expected highest individual dose could be 20 microSv per year. However, taking into account the actual situations, annual doses of less than 2 microSv have been predicted for the critical group of members of the population.

## Contents

	List of tables	144
	List of figures	144
1	Introduction	145
1.1	Background	145
1.2	Objectives	145
1.3	Scope of work	145
1.4	Outline of this report	146
2	Transport operations for the nuclear fuel cycle	147
2.1	Nuclear fuel cycle facilities in the Netherlands	147
2.2	Shipments of irradiated fuel	147
2.2.1	Shipments and exposures in 2001	147
2.2.2	Radiation exposures in 2001	149
2.2.3	Trends in exposures and shipments	149
2.3	Shipments of radioactive waste resulting from nuclear fuel cycle operations	150
2.4	Shipments of uranium hexafluoride	151
3	Distribution and supply of radioisotopes	152
3.1	Shipments in 2001 of Consignor A	152
3.1.1	Transport operations	152
3.1.2	Trends in shipments and exposures	152
3.2	Shipments in 2001 of Consignor B	153
3.2.1	Transport operations	153
3.2.2	Trends	153
4	Conclusions	154
	References	155

## List of tables

Table 1:	Nuclear fuel cycle facilities in the Netherlands	147
Table 2:	Shipments of irradiated fuel in 2001	148
Table 3:	Estimated exposures of critical groups of the population for shipments of irradiated fuel	149
Table 4:	Shipments of waste packages from nuclear reactors in 2001	150
Table 5:	Shipments of uraniumhexafluoride	151
Table 6:	Trends in exposures of workers involved in shipments with a large number of packages with a high TI-value	153
Table 7:	Trends in exposures of workers involved in shipments with a small number of packages with a low TI-value	153
Table A 1:	Shipments of irradiated fuel from Dodewaard NPP	158
Table A 2:	Collective doses for shipments during 2001 and 2002 from Dodewaard NPP	158
Table A 3:	Collective doses for shipments during 1988 –1996 from Dodewaard NPP	159
Table A 4:	Collective doses for shipments during 1994 –1996 from Borssele NPP	163
Table A 5:	Shipments of radioactive waste to COVRA during 2001	167
Table A 6:	Annual shipments of radiopharmaceutica by consignor A	169
Table A 7:	Trends in exposures of workers of consignor A	171
Table A 8:	Shipment data for Consignor B	172
Table A 9:	Exposure data for shipments of Consignor B	172
Table A 10:	Exposures of workers involved in the preparation of irradiated fuel shipments from the Dodewaard NPP during 2001	174
Table A 11:	Exposures of workers involved in the preparation of irradiated fuel shipments from the Dodewaard NPP during 2002	175

## List of figures

Figure 1:	Control operations at Dodewaard before shipment and NTI-15 fuel flask in barge	148
Figure A 1:	Collective doses of workers involved in the preparation of shipments of irradiated fuel sent from Dodewaard NPP (owner GKN) during 2001 and 2002.	159
Figure A 2:	Collective dose of workers involved in the preparation of shipments of irradiated fuel sent from Borssele NPP (owner EPZ) during 2001	162
Figure A 3:	Facility for interim storage of conditioned low- and intermediate level radioactive waste at COVRA	166
Figure A 4:	Shipping pattern of consignor A presented in percentages of the total number of packages shipped	169
Figure A 5:	Collective doses per week due to handling and driving	171



## Introduction

### Background

Transport of radioactive materials (RAM) in the public domain is a regulated operation such as defined in the EURATOM Directive of 1995 ‘Basic Safety Standards’ [1] and is bound by International Transport Regulations, ADR (road), RID (rail), ICAO TI (air) and IMDG Code (sea). The specific rules for transport of RAM in these regulations are based on the “Regulations for the Safe Transport of Radioactive Material” developed, maintained and disseminated by the International Atomic Agency (IAEA) and published in Safety Standard Series Nos. TS-R-1 [2] and TS-G-1.1 [3].

Compliant to Article 14 of Title IV of the Council Directive 96/29/Euratom [1] national competent authorities are obliged to arrange for periodic assessments of the total radiation dose to members of the public resulting from all practices, including transport of RAM.

Availability of comprehensive and evaluated information on shipments of RAM in the EU Member- States and applicant countries is important for several reasons:

- Demonstration of the efficacy of the international Transport Regulations of the IAEA [2, 3].
- Provision of support for the continuous review and revision process of the international Transport Regulations.
- Provision of support and guidance to assure the compliance to these Regulations.
- Provision of data for assessing and evaluating the doses and risks to workers and to members of the public, compliant to the Council Directive 96/29/Euratom (IV.14) [1].
- Identification of needs and trends in international transport activities.
- Provision of factual information to assist in addressing questions and safety concerns of the European Parliament, the public concerns.

As part of their multiannual programme (1998-2002) [4], the European Commission awarded in 2001 a contract (No. 4.1020/D/01-003 of DG-TREN) to collect, compile and analyse statistical data, including exposure data, of RAM shipments by all modes in the public domain, in EU Member States and EU Applicant Countries. NRPB UK (co-ordinator), GRS Germany, IPSN (subcontractor CEPN) France, ANPA (APAT) Italy and NRG Netherlands performed this study. These organisations are all highly experienced in work associated with radioactive material transport databases and the analysis of transport data.

### Objectives

The objectives of the present contract study for the European Commission (DG-TREN) are to:

- collect and compile information on the type, volume and radiological characteristics of and the doses arising from radioactive material shipments in the European Union and in the countries applying for accession;
- perform statistical analyses of the compiled data by type of package, type of transport and use of the radioactive material shipped;
- perform statistical analyses of radiation exposures to workers and members of the public by type of package and transport, and
- produce a full report to the Commission.

### Scope of work

The present study includes the compilation and analysis of shipment data and exposure data. For this compilation the latest available data should be included, primarily data for the late 1990s. For the Netherlands analysed data on radioactive material shipments were already reported for the years between 1992 and 1998. For the present study, shipment data for the Netherlands have been compiled for the year 2001. This year was the first year with frequent shipments of irradiated fuel, after cancellation of the ban on this kind of shipments imposed in 1997.

Using results of previous compilations, trends in transport have been identified and reported for those shipments where sufficient data were readily available.

The compilation of radioactive material transport data for the Netherlands, reported here, has been included in the main part of the contract report to the Commission, together with the compiled data from the other contractors. Transport data from applicant countries and EU Member States other than those involved in the contract were obtained by a questionnaire survey. The relevant questionnaire forms for this survey covering transport and exposure data were developed as part of the contracted work.

## **Outline of this report**

This report presents the details of shipment data and exposure data on transport operations in the Netherlands, which are used in the main part of the contract report. The present report is added as an annex to this contract report.

Chapter 2 of the report presents transport data and statistical analyses for shipments of nuclear fuel cycle material. Chapter 3 presents data on shipments for the distribution and supply of radioisotopes. Chapter 4 presents data on shipments of radiation sources and radioactive waste material from laboratories and non-nuclear industry. Background information is presented in annex A to this report. Data on shipments before 2001 used in trend analyses have been reported elsewhere, partially in contract reports for the European Commission [5, 6, 7].

Conclusions from the present study are presented in chapter 5. Data on shipments during 2001 have also been inserted in the questionnaire forms, see annex B of this report.

## Transport operations for the nuclear fuel cycle

### Nuclear fuel cycle facilities in the Netherlands

In the Netherlands are several nuclear fuel cycle facilities, including two nuclear power plants (NPP) and an enrichment facility. Information on these facilities is summarised in Table 1. The Dodewaard NPP has been decommissioned and most of the spent fuel has been removed from the site. The High Flux Reactor (HFR), the research reactor owned by the Joint Research Centre of the European Commission, has shipped spent fuel recently.

**Table 1: Nuclear fuel cycle facilities in the Netherlands**

Facility	Additional information	Nuclear fuel cycle materials
Borssele NPP	450 MW <sub>e</sub> PWR, KWU design	Fresh fuel, irradiated fuel and waste
Dodewaard NPP	58 MW <sub>e</sub> BWR, GE design (decom.)	Irradiated fuel and waste
COVRA	Waste storage facility near Borssele	Waste and irradiated fuel
HFR	45 MW <sub>th</sub> research reactor in Petten	Fresh fuel, irradiated fuel and waste
HOR	2 MW <sub>th</sub> research reactor in Delft	Fresh fuel, irradiated fuel and waste
LFR	0.03 MW <sub>th</sub> research reactor in Petten	waste <sup>a)</sup>
Urenco	Enrichment facility near Almelo	UF <sub>6</sub> ; nat.-, enriched and depleted U

a) Irradiated fuel will not be removed until decommissioning of the reactor.

### Shipments of irradiated fuel

Between spring 1997 and autumn 1999, shipments of irradiated nuclear fuel were banned in the Netherlands. Before 1997, there were 10 to 15 transports of irradiated fuel per year per NPP. Shipments of irradiated fuel from the research reactors were also affected by the ban.

### Shipments and exposures in 2001

There were 14 shipments of irradiated fuel in 2001. In this paragraph details of these shipments are discussed per consignor. A summary of the shipments of irradiated fuel in 2001 is presented in Table 2.

#### Dodewaard NPP

In total 19 shipments of irradiated fuel are required to remove all 183 irradiated fuel elements that were left at the fuel storage pond after the final reactor stop of the Dodewaard NPP. After completion of these 19 shipments the next phase of the decommissioning with less constraining regulatory regime can start.

The first shipment after cancellation of the ban on shipments took place in December 2000. This shipment was number 93 since the commissioning of the plant. In total 800 fuel elements were shipped before 2000.

There were seven shipments in 2001 (no. 94 – 100) from Dodewaard NPP to Sellafield (UK). BNFL was the carrier and consignee of these shipments. Irradiated fuel elements as well as the control rods are transported in one fuel flask of type NTL-15. This fuel flask has 10 positions for fuel elements. The first part of the journey to Sellafield is transport by road from Dodewaard NPP to the harbour of Vlissingen-East. The average travel time is 3 ½ hours. At the harbour the flask is moved from the truck to a special barge for the second part of the journey. Transfer and control operations at the harbour take 5 to 6 hours to complete. Travel from Vlissingen to Barrow (West Cumbria, UK) takes about 3 ½ days.

Control of the fuel flask before shipment and position of the flask (with impact limiters) in the barge is shown in Figure 18. Further details of these shipments are presented in Annex A.1.



© Dodewaard NPP: Annual report 2001, July 2002.

**Figure 18: Control operations at Dodewaard NPP before shipment and NTI-15 fuel flask in barge**

#### Borssele NPP

Five shipments of irradiated fuel from Borssele NPP to the reprocessing facilities at Cap-la Hague were prepared in 2001. Each shipment contained three fuel flasks of type TN 17/2 with seven spent fuel elements each. The first part of the journey of these shipments is transport by road from the Borssele NPP to the nearby railway freight station. The second part of the journey is transport by train from the harbour at Vlissingen-East, via a large marshalling yard to the Belgium border. The third part of these shipments is transport by train from the Belgium border to Cap La Hague in France.

#### HFR research reactor

There was only one shipment of irradiated fuel in 2001. With this shipment three flasks of type NAC-LWT were transported from the HFR to the harbour of Den Helder. The three flasks are owned by Transnucleaire and certificated by the US-DOT. In Den Helder the three flasks were loaded for sea transport to Savannah River, USA. Each NAC-LWT flask contains 39 fuel elements.

**Table 2: Shipments of irradiated fuel in 2001**

Parameters	Consigner of the shipment		
	Dodewaard NPP	HFR	Borssele NPP
Consignee			
Number of shipments	7	1	6 <sup>a)</sup>
No of flasks per shipment	1	3	3
Type of flask	NTL 15	NAC-LWT	TN 17/2
Number of fuel elements per Flask	10	39	7
Average collective dose per shipment preparation [man-mSv]	1.46	-	2.26

a) The first shipment in 2001 was prepared in December 2000 and has 6 elements per flask.

## Radiation exposures in 2001

Data on doses of exposed (monitored) workers involved in the preparation of the irradiated fuel shipments have been obtained for Dodewaard NPP and Borssele NPP, see Table 2. In appendix A.1 further details on exposures of workers can be found.

There are no measurements available for doses received by members of the public exposed to shipments of irradiated fuel. However, assessments of the potential dose of members of the public are available from risk-analyses made in support of the transport licence application by the consignor, see Table 3. The methodology of these risk-analyses and parameters used are described elsewhere [6, 8]. The assumed dose rate at 2 m from the outer surface of the transport is 100 microSv/hour. In practice, the dose rates at this distance are smaller than 20 microSv/hour.

**Table 3: Estimated exposures of critical groups of the population for shipments of irradiated fuel**

Parameters	Flasks and maximum received dose per shipment		
	Dodewaard NPP	HFR	Borssele NPP
No of flasks per shipment	1	3	3
Critical group of residents next to road	0.011 microSv	0.014 microSv	-
Critical group of local traffic	0.05 microSv	0.3 microSv	0.029 microSv
Critical group of residents next to railway	-	-	0.006 microSv
Critical group of residents next to yard	-	-	3.2 microSv
Critical group of train passengers	-	-	0.19 microSv

## Trends in exposures and shipments

### Dodewaard NPP

Before 1997, spent fuel from the Dodewaard BWR power plant was also shipped in NTL-15 flasks with 10 BWR fuel elements each. The average values of the collective dose received per flask handling (cleaning, loading, cleaning) was 2.10 man-mSv. Presently, collective doses have been decreased although much more extensive cleaning and monitoring procedures have to be applied. Collective dose per shipment in 2001 and 2002 is respectively, 1.46 and 0.75 man-mSv.

In 2003, there will be three shipments of irradiated fuel from Dodewaard NPP. After these shipments the fuel storage pool is empty and the decommissioning activities will proceed to a next stage.

### Borssele NPP

Before 1997, spent fuel from the Borssele PWR power plant was shipped in one TN 17/2 flask per shipment with 3 irradiated fuel elements pr flask. Exposure data from shipments during 1994 – 1996 show an average collective dose of 1.25 man-mSv per shipment. Presently with 3 flasks per shipment and 7 fuel elements per flask, the average dose per shipment is 2.26 man-mSv. Hence, also for the shipments from Borssele NPP the average dose per flask preparation has been decreased.

In 2003 and in the next years frequent shipments of irradiated fuel from Borssele NPP will take place.

## Shipments of radioactive waste

Radioactive waste generated in the Netherlands is collected by the Central Organisation for Radioactive Waste (COVRA). COVRA is the Dutch national central organisation for collecting, conditioning and storage of radioactive waste. The site of this organisation is in Vlissingen-East, close to the Borssele NPP. The organisation collects the waste using its own trucks and drivers. In 2001, 78 transports of unconditioned and 80 transport with conditioned low- and intermediate level wastes took place. In total 3876 colli/packages were collected in 2001. Presently, COVRA is 100% State owned by the Ministry of Finance, represented by the Ministry of Environment.

## Radioactive waste from the nuclear power plants

The nuclear power plants generate various types of radioactive waste. The low-level solid waste, such as tissues, gloves etc. is compressed in drums. Low-level liquid waste is processed (via filtration and evaporation) to solid waste and also compressed (conditioned) in drums. Intermediate liquid waste such as ion-exchange filters is solidified and packed as conditioned waste in 200 liter- and 1000 liter concrete drums (Industrial Package). Solid intermediate waste (metals, etc.) is cut and conditioned in concrete drums. Data on shipments and packages are presented in Table 4. In total 65 shipments of 876 waste packages related to the fuel cycle have been transported in 2001.

**Table 4: Shipments of waste packages from nuclear reactors in 2001**

Parameters	Consignors	
	Dodewaard NPP	Borssele NPP
Number of shipments of conditioned waste	11	48
No of 1000 l containers	29	2
No of 200 l containers	67	507
No of 100 l containers	0	51
No of 100 l solid waste transported by COVRA	66	154
Estimated shipments	2	4

For further information on shipments of radioactive waste, see Appendix A.2.

## Radioactive waste from the research institutes, hospitals and non-nuclear industry

Packages with solid waste and liquid waste from research institutes and hospitals are collected annually by COVRA. In 2001, 2979 packages have been shipped to COVRA (72 shipments). In addition 21 shipments with one container of conditioned NORM contaminated materials have been transported.

## Shipments of uranium hexafluoride

For the operation of the facility of URENCO in Almelo frequent shipments of uranium hexafluoride ( $UF_6$ ) to and from this facility are carried out by road. Data on these shipments are presented in Table 5. More details on these shipments are presented in Appendix A.3.

Annual doses due to exposures during handling and driving the containers with  $UF_6$  are low.

**Table 5: Shipments of uraniumhexafluoride**

Type of $UF_6$ shipments	Annual number of shipments	Annual number of packages
Natural (in 48Y, type IP)	125	330
Depleted (in 48Y, type IP)	100	280
Enriched (in 30 B, type A)	55	270



## Distribution and supply of radioisotopes

There are several suppliers of radioisotopes in the Netherlands. Some of them have also their own production centre. As a result of this situation there is a large annual number of shipments of radioisotopes in the Netherlands, most of these are international shipments of radiopharmaceuticals shipped by road or by air.

For the present study, data on shipments in 2001, 2002 for two large consignors of radiopharmaceuticals have been evaluated. Consignor A has a radioisotope production centre and ships annually more than 220000 from its distribution centres. This consignor has been evaluated in two previous EC studies. Consignor B mainly imports and distributes radiopharmaceuticals, in about 30000 packages per year. In addition to these radiopharmaceuticals also radioisotopes for industrial application are shipped in the Netherlands. These shipments include the 60 sources in type-B package used by a company for non-destructive testing transported by a van (testing of pipelines with Cs-137 source). Total distance travelled per year is 2000 km.

## Shipments in 2001 of Consignor A

### Transport operations

In 2001 Consignor A transported 220 000 packages of radioisotopes from its production site in Petten. These packages are mostly type A packages, of which 55000 are A-packages with Tc-generators (Mo-99). Activity in the other 165 000 packages are more or less equally distributed over the radioisotopes Ga-67, I-131, I-123, In-111, Ir-192 and Tl-201. In addition ca 50000 packages with miscellaneous non-radioactive accessories are shipped.

Consignor A ships 50% of its packages to Germany (two vehicles in one day, five days a week), 11% to Belgium, 6% to France (five times a week) and 33% to Schiphol airport (about twenty times a week). From Schiphol airport the packages are flown to many destinations. A part of inventory shipped to Schiphol is not loaded into an aircraft but is shipped by truck to a distribution centre (4%) in the city of Zaandam (twenty times a week). Also a large part of the shipments to the UK is transported by road. The cargo for all destinations is a mix of type A packages with Mo-generators, I-131, I-123, Ga-67 and In-111. Five times a week 90% of the Mo-generators for Germany returns to Petten after being used, resulting in a volume of 24700 colli per year. Furthermore five times a week a truck with I-131 and Ir-192 sources travels from Schiphol airport to Petten, resulting in 5460 colli per year.

In 3400 journeys, a 260 000 kilometers are travelled on Dutch roads by consignor A, shipping a total activity of some 2500 multiples of A2. The average number of packages per shipment (120) and average TI-value per package are relatively high (0.8). For details and exposures, see appendix A.4.1.

### Trends in shipments and exposures

Data and discussions of shipments of radioisotopes by consignor A before 2001 and exposures resulting from these shipments have been presented in a number of studies [5, 6]. Data from these studies have been compared with data of recent shipments in Table 6. The conclusion is that the use of a mechanical sorting system, additional shielding and further improvements of procedures have reduced the average dose per package handled. The average annual individual dose of the handlers is about 6 mSv. The maximum value recorded for the annual individual dose is just below 10 mSv. Also for the drivers the present average dose per shipment has been decreased in comparison with the average doses in 1998.

Because the number of shipments has been increased only by 9% since the last evaluation in 1998, the estimated maximum individual dose of the critical group of members of the public has not been changed. For exposures to the shipments in 1998, a maximum value of 1,6 microSv/year has been estimated.



**Table 6: Trends in exposures of workers involved in shipments with a large number of packages with a high TI-value**

Parameter	Value in 1997	Value in 2001
Cumulated TI-value handled	140000 TI	168000 TI
Recorded annual dose of handlers	125 man-mSv	91 man-mSv
Cumulated TI-value shipped	52000 TI	52000 TI
Recorded annual dose of drivers	41 man-mSv	30 man-mSv

## Shipments in 2001 of Consignor B

### Transport operations

In 2001 Consignor B transported about 28 000 packages of radioisotopes from its distribution centre at Eindhoven. These packages are mostly type A packages, with a low TI-value. Per vehicle movement (shipment) 2 to 12 packages are shipped. About 40% of the packages are shipped to destinations outside the Netherlands. Shipments with destinations within the Netherlands include mostly type A-package. Less than 5% of these shipments are excepted packages.

In 2001, effectively 23 monitored workers were continuously involved in the transport operations. The total collective dose of this group of workers was 9.2 man-mSv. This means about 0.3 man-microSv/per package. The maximum individual dose in 2001 was 2.1 mSv.

### Trends

*In 2002 more packages were shipped. From the total 31000 packages 50% were shipped abroad. The average number of packages per shipment was less than 10.*

*The effective number of monitored workers dropped from 23 to about 17 persons. The collective doses of this group is 10 man-mSv. This means that the collective dose per package was equal to the value in 2001. The maximum individual dose in 2002 was 2.9 mSv.*

*A summary of shipments of Consignor B and exposure data are presented in Table 7.*

*It may be concluded that, with increasing transport operations, exposures are not increasing.*

**Table 7: Trends in exposures of workers involved in shipments with a small number of packages with a low TI-value**

Parameter	Value in 2001	Value in 2002
Total packages handled and shipped	28000	31000
Average number of package per shipment	2.8	3.0
Annual collective dose	9.2 man-mSv	10 man-mSv
Maximum individual annual dose	2.1 mSv	2.9 mSv

## Conclusions

Data on shipments of radioactive material in the Netherlands during 2001 have been collected and compared with data from previous years. Doses of workers and members of the public exposed to these shipments have been assessed.

Data collected on transport operations in the Netherlands during 2001 include:

- Shipments of flasks with irradiated fuel elements from NPP Borssele, NPP Dodewaard and the research reactor HFR at Petten;
- Shipments of intermediate- and low-level radioactive waste to the storage facility of the national organisation for radioactive waste COVRA;
- Shipments of radioisotopes in use for medical, scientific and general industrial applications;
- UF<sub>6</sub> shipments to and from Urenco, Almelo.

The collected data show that most of the shipments in the Netherlands (> 95%) are shipments of radioisotopes for medical applications. The total number of these shipments has not been changed much during the last years.

From the recorded doses of workers involved in transport operations it may be concluded that individual annual doses are less than 10 mSv, during recent years. The highest annual doses received by transport workers are the doses of handlers involved in the preparation of shipments of radiopharmaceuticals. It has been observed that the collective doses of these handlers are decreasing due to operational and technical measures. The average collective dose per TI handled has been reduced from 1 man-microSv/TI (1998) to 0,5 man-microSv/TI (2002).

Dose reductions have also been found for the group of workers involved in the preparation of shipments of irradiated fuel, although presently the monitoring and cleaning operations are more extensive than before 1997, the year in which these shipments were banned. The estimated annual individual dose only due to preparation of shipments is about 2 mSv.

The maximum value of the annual individual dose of workers involved in the collection of waste packages is 1 mSv.

Exposures of members of the critical groups of the population have been assessed from model-calculations based on actual situations and traffic statistics. Theoretically, the highest expected individual dose is about 20 microSv per year. This value is found for the hypothetical group of residents living near the freight station where flasks are transferred from truck to train wagon (15 microSv per year) and for the hypothetical group of drivers which use the same route and driving at the same time as shipments of radiopharmaceuticals. However, taking into account the actual situations, annual doses of less than 2 microSv have been estimated for the critical group of members of the population.

## References

- [1] Council Directive 96/29/Euratom of 13 May 1996 laying down basic safety for the protection of the health of workers and general public against the dangers arising from ionising radiation.
  - [2] International Atomic Energy Agency, Regulations of the Safe Transport of Radioactive Material, Requirements, Safety Standards Series No. TS-R-1 (ST-1, Revised), IAEA, Vienna (2000).
  - [3] International Atomic Energy Agency, Advisory Material for the IAEA Regulations of the Safe Transport of Radioactive Material, Safety Guide, Safety Standards Series No. TS-G-1.1 (ST-2), IAEA, Vienna (2002).
  - [4] Multiannual programme (1998-2002) for actions in the nuclear sector as adopted by the European Commission with the Council Decision 1999/25/EC, Euratom of 14 December 1998.
  - [5] Final contract report for EU/DG-TREN, contract no. 4.1020/D/96-002: Assessment of the Radiological Risks in Transport Accidents Involving Type A Packages (GRS, NRPB, CEPN, SSI, NRG), 1998.
- 
- [6] Final contract report for EU/DG-TREN, contract no. 4.1020/D/97-003: The Evaluation of the Situation in the EC as Regards Safety in Transport of Radioactive Material and the Prospects for the Development of such Type of Transport (GRS, NRPB, SSI, NRG), 1999.
  - [7] Final contract report for EU/DG-TREN, contract no. 4.1020/D/99-004: Application of the ALARA principle to the decontamination of transports of irradiated fuel (NRPB, GRS, TRANSNUCLEAIRE/ NUSYS, NRG, CEPN), 2001.
  - [8] Public exposures due to frequent shipments of radioactive material by road, RAMTRANS, Vol 10, No. 1, pp. 45 –49, Nuclear Technology Publishing (1999).
  - [9] COVRA, quarterly report nr. 57, October, November, December 2001.



## APPENDIX A: Details of RAM transport in 2001 and trends

### Shipments of irradiated fuel

#### A.1.1 Shipments from Dodewaard NPP

##### **Recent fuel shipments**

The Dodewaard NPP has a BWR reactor with an output of 58 MWe and is owned by GKN. Dodewaard NPP ended operation in 1997 and decommission activities were started. At that time, 19 shipments of irradiated fuel would be required to remove all 133 spent fuel elements left at the reactor basin. After removal of these elements the next phase of the decommissioning could start within a less constraining regulatory regime.

In December 2000 after cancellation of the ban on irradiated fuel shipments the first shipment from Dodewaard NPP was sent to Sellafield in the UK. This shipment was number 93 since the commissioning of the plant. In 2001 and 2002 another 15 shipments were sent.

British Nuclear Fuel plc (BNFL) is the carrier en consignee of these fuel shipments. Irradiated fuel elements as well as the irradiated control rods are transported in the same fuel flask of type NTL-15. The length and diameter of the flask including the impact limiters are 3.92 m and 1.7 m, respectively. The NTL-15 flask has ten positions for fuel elements. During the transport by road from the plant to the Harbour of Vlissingen-East the flask is positioned at the centre of large trailer with a width of 2.5 m and is enclosed in a canvass hood. This hood extends at a distance of 2 m behind the end of the container. The outside of the hood/skirt is considered as being the external surface for the transport, for which the contamination levels and radiation levels should comply to national regulations in accordance with the ADR.

At the harbour the NTL-15 fuel flask is moved from the truck to a special barge for the second part of the transport to Sellafield in the UK. The average burn-up of fuel elements in these shipments varies between 14.2 to 28.7 GWd/tHM. The initial maximum amount of heavy metal per element is 58,5 kg Uranium.

During the first shipment in December 2000, one NTL-15 flask with three irradiated fuel elements was sent to Sellafield. In 2001 and 2002, respectively, seven and eight shipments were sent. These shipments involved one NTL-15 flask with seven irradiated fuel elements. Table A 1 presents the details of these 15 shipments. In 2003, the three last shipments will be organised.

Before each shipment of irradiated fuel, there was a shipment of an empty NTL-15 flasks to Dodewaard NPP. These shipments in principle do not carry radioactive material. No contamination above the regulatory limit was observed on these empty flasks.

##### **Monitored exposures of workers during recent shipments**

The group of reactor operators of the Dodewaard NPP is also involved in loading of the fuel and the remote handling of the flask. The service group of the NPP staff cleans the flasks before contamination control and, when needed, also after contamination control. The monitoring group performs the wipe test and the dose rate measurements.

Members of the service group and monitoring group are plant personnel. The average collective doses received per shipment for different operations are presented in Table A 2 for the years 2001 and 2002. A graphical display of these doses per shipment is shown in Figure A 1. The details of the data are presented in Table A 10 and Table A 11. The average value of the total collective dose per shipment for these two years is respectively, 1.46 and 0.75 man-mSv. The effect of the introduction of these new procedures is visible during the first two shipments, see Figure A 1. The first seven shipments shown in this figure were organised in 2001.

**Table A 1: Shipments of irradiated fuel from Dodewaard NPP**

Shipments in 2001		Shipments in 2002	
No. Shipment	Date	No. Shipment	Date
94	25 January	101	19 February
95	1 March	102	3 April
96	9 May	103	15 May
97	12 June	104	19 June
98	5 September	105	4 September
99	17 October	106	8 October
100	28 November	107	5 November
		108	10 December

**Table A 2: Collective doses for shipments during 2001 and 2002 from Dodewaard NPP**

Stage	Operation	Collective dose [man-mSv]	
		2001	2002
Loading	Plant operators loading the flask	0.69	0.30
	Service group cleaning the flask	0.41	0.14
Cleaning & preparation	Monitoring personnel	0.10	0.11
	Non-plant staff involved in preparation	0.26	0.20
All stages		1.46	0.75

The plant operators are relatively more exposed than the other groups. The total collective dose for this group for preparation of 7 shipments only is about 5 man-mSv. With a group of 4 persons the maximum annual individual dose to loading fuel flasks only is less than 2 mSv.

#### Assessment of exposures of members of the public

Dose assessments have been made for the critical group of residents living near the road used for the transportation of the shipments and for the hypothetical critical groups of drivers involved in local traffic and be exposed to each shipment. A relevant parameter for the dose assessment of members of the public is the dose rate at 2 meter from the outside of the trailer (outside of the hood). In practice, the actual dose rates at 2 m distance from the trailer and hood during shipments are far less than the regulatory limit of 100 microSv/uur. It often varies between 10 to 20 microSv/uur.

Calculating with the conservative assumption that the dose rates at 2 m distance from the trailer are equal to 100 microSv/hour for all 7 shipments, the maximum individual annual effective dose of the critical group of local residents is equal to 0.08 microSv. The calculated maximum individual effective dose of the hypothetical critical group of drivers is equal to 0.35 microSv.

#### **Trends in shipments and workers exposures at Dodewaard NPP**

Between 1988 and 1996, there were 37 shipments of empty flasks and 37 shipments of loaded flasks from and to BNFL. In each shipment 10 irradiated fuel elements were packed in a NTL-15 fuel flask. The average value of the collective dose received per shipment (cleaning, loading, cleaning of the flask) for these 37 shipments is 2.10 man-mSv. It was assumed that during the handling of the empty flask no transport related exposure takes place. The average collective doses received per shipment for different operations during the shipments between 1988 and 1996 are presented in Table A 3.

From a comparison of the collective doses for shipments before 1997 (2.10 man-mSv) and those for recent shipments (1.10 man-mSv), we observe a trend of decreasing doses. This decrease may be explained by the

ALARA awareness of the staff because the present extensive cleaning and monitoring procedures require longer exposures of the staff to the loaded fuel flask.

**Table A 3: Collective doses for shipments during 1988 –1996 from Dodewaard NPP**

Stage	Operation	Collective dose [man-mSv]
Loading	Plant operators loading the flask	0.72
	Service group cleaning the flask	0,76
Cleaning & preparation	Monitoring personnel	0,11
	Non-plant staff involved in preparation	0,51
All stages		2.10

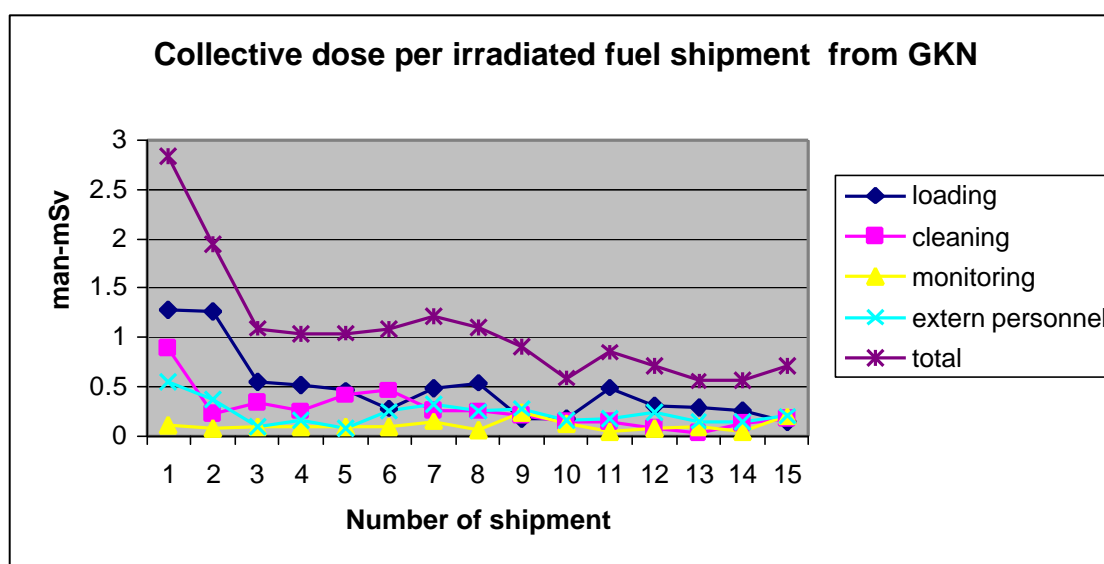

**Figure A 1: Collective doses of workers involved in the preparation of shipments of irradiated fuel sent from Dodewaard NPP (owner GKN) during 2001 and 2002.**





## A.1.2 Shipments from Borssele NPP

### **Recent fuel shipments**

The Borssele NPP has a PWR reactor with an output of 450 MWe. Borssele NPP is owned by EPZ and is expected to operate till 2013. After lifting of the ban on irradiated fuel shipments, transport operations at Borssele NPP started in 2000 with the arrival of an empty fuel flask from Cogema and the preparation of the first shipment of three TN17/2 flasks with irradiated fuel. Early January 2001 this shipment was transported to Cogema's reprocessing facility (Cap La Hague). Later that year, additional 5 shipments also with three TN17/2 flasks were prepared and transported. In 2002 also several shipments were transported to Cap La Hague.

During these transport operations the fuel flasks are carried by truck from the Borssele NPP to the nearby railway freight station, which is located at the harbour in Vlissingen. After transfer to a train wagon, the fuel flasks are transported by railway to a large marshalling yard. From this yard the fuel flasks are transported by train via Belgium to Cap La Hague.

During the first shipment, prepared in December 2000, 6 fuel elements per flask were loaded. During the next shipments up to 7 elements per flasks were loaded. In 2001, in total six shipments, including the one prepared in 2000 were transported to Cap La Hague.

### **Monitored exposures of workers during recent shipments**

The staff of the Borssele NPP mainly performs the preparation of the irradiated fuel shipments. The collective dose of the exposed workers has been differentiated for various operations during the subsequent stages of the preparation of a shipment, i.e. receiving the empty flask, loading the fuel elements (wet loading) and cleaning the flask before transport. It was assumed that during the reception of the empty flask no transport related exposure took place. The group of reactor operators was involved in loading of the fuel and the remote handling of the flask. The service group performed the wet cleaning of the flask and attaching protective foils to it for protection against contamination during loading. This group cleaned the loaded flasks before contamination control and, when needed, also after contamination control. The monitoring group performed the wipe tests and the dose rate measurements. Members of the service group and monitoring group are plant personnel. These preparations for one shipment normally take about 3 days (day-time shift) with two groups of two men each.

The recorded collective dose due to exposures during the preparation of the first shipment in 2000 was about 5 man-mSv. The collective doses received during the preparation of the next shipments in 2001 were smaller than this high value, see Figure A 2. The main cause for the high value of the collective dose for the first shipment and the fluctuation of the doses for the next shipments is the stringent and extensive decontamination procedures, which were put in place by the Responsible Authorities after the ban on shipments was lifted. Therefore the collective dose received per shipment, which depends on exposure time, is very depending on the problems met during preparation. For example, cleaning of the (7000) cooling fins of the TN 17/2 flask, after discovering a contamination, costs about 24 hours of work for 5 man.

The average collective dose per shipment prepared in 2001 is 2.3 man-mSv. The estimated maximum annual individual dose due to preparation of shipments only is about 2 mSv.

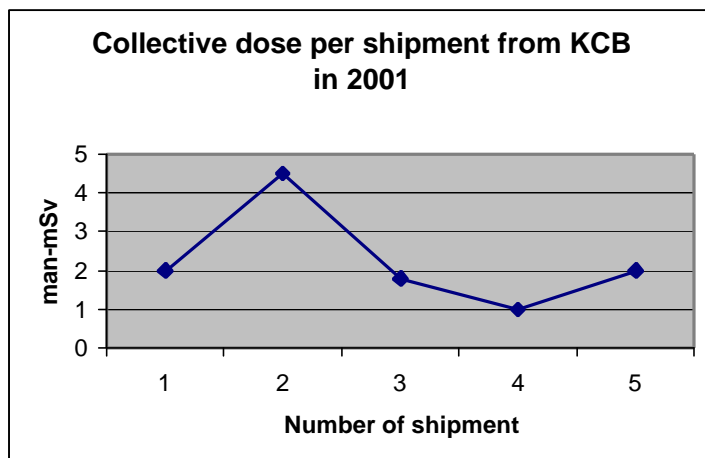

Figure A 2: Collective dose of workers involved in the preparation of shipments of irradiated fuel sent from Borssele NPP (owner EPZ) during 2001

#### Assessment of exposures of members of the public

Dose assessments have been made for the critical groups of the population exposed during the transportation of the 6 shipments during 2001. During the journey of the fuel flasks from the NPP to the nearby railway freight station, no residents were exposed, because no people are living near the road from Borssele NPP to the freight station. However, there is a critical group of local traffic drivers and passengers using this road, who could have been exposed to all six shipments. The maximum calculated value of the individual dose for this critical group is 1.8 microSv.

Also an assessment has been made of the exposures of members of the critical group of residents living near the railways and exposed to shipments travelling by rail from the freight station to the Belgian border. The maximum of the calculated value of the individual dose of members exposed to all six shipments is less than 0.034 microSv. In case each shipment should have stayed during two hours on the large marshalling yard, the calculated maximum annual individual dose of residents living near this marshalling yard would be 19 microSv.

There is another unspecified group of train passengers who could have been waiting at stations' platform when the shipments were passing. The calculated maximum individual dose for this group is 1.1 microSv, if these passengers would have been exposed to all six shipments.

Based on assessment studies for similar type of shipments in the UK, the estimated dose for workers involved in loading the containers from the truck to the train would be 4 à 6 microSv for these six shipments.

#### **Trends in shipments and workers exposures at Borssele NPP**

Between 1988 and 1996, there were 110 shipments of empty flasks and 110 shipments of loaded flasks from and to Gogema. In each shipment 3 irradiated fuel elements are transported in one flask of type TN 17/2. Exposure data are available for shipments during 1994 – 1996. The average value of the collective dose received per shipment (cleaning, loading and cleaning of the flask) is 1.25 man-mSv. This average dose value has been differentiated for various operations during the subsequent stages of the preparation of a shipment, i.e. receiving the empty flask, loading the fuel elements (wet loading) and cleaning the flask before transport, see Table A 4. It was assumed that during the reception of the empty flask no transport related exposure took place.

From a comparison of the collective doses for shipments before 1997 (1.25 man-mSv) and those for recent shipments (2.3 man-mSv), an increase of the collective dose is observed. However, taking into account the number of fuel flasks per shipment and number of fuel elements per flask, before and after 1997, one concludes to a trend of decreasing doses. As mentioned before, the collective dose may vary per shipment

because any contamination could lead to longer exposures to the loaded flasks due to the present extensive cleaning and monitoring procedures.

**Table A 4: Collective doses for shipments during 1994 –1996 from Borssele NPP**

Stage	Operation	collective dose [man-mSv]
Loading	Plant operators loading the flask	0.55
Cleaning & monitoring	Service group cleaning the flask Monitoring group	0.45 0.25
All stages		1.25

### A.1.3 Shipments from the HFR

#### **Recent fuel shipments**

The High Flux Reactor (HFR) at Petten has an output of 45 MWth and is owned by the Joint Research Centre of the European Commission (JRC). The HFR uses highly enriched fuel (HEU). Before the ban on irradiated fuel shipments in 1997, irradiated HEU fuel was returned to the USA. However as a result of the non-proliferation policy of the US, these return shipments were suspended till 2001, when JRC decided to transfer from HEU to LEU fuel. Therefore after lifting of the ban in autumn 1999, the irradiated fuel was shipped to the national waste storage facility of COVRA. During early 2000 another three shipment were carried out. Each shipment carried one CASTOR MTR-2 flask with irradiated HEU fuel to COVRA for temporary storage.

In 2001, after return shipments to the USA were permitted again, one shipment of spent fuel was transported by road to the harbour of Den Helder. During this shipment 3 flasks of Type NAC-LWT, owned by Transnucleaire were used. In the harbour the flasks were loaded into a ship for further transport to Savannah River, USA. Each NAC-LWT flask contained 39 fuel sections (a maximum of 42 fuel sections could be shipped). During the transport each flask was placed inside a ISO-container mounted on a drop frame trailer. The length of the NAC-LWT container, inclusive impact limiters, is 5.89 m, with a diameter (inclusief impact limiters) of 1,65 m. Each fuel section has a weight of about 300 gram and has an average burn-up of 143 MWd. The average storage time in the HFR before shipment was 7 years.

#### **Monitored exposures of workers during recent shipments**

The staff of the HFR performed the preparation of the irradiated fuel shipments. The collective dose of the exposed workers involved in the preparations of the shipments in 1999 and 2000 is very small because of the very low external dose rates at the loaded MTR-2 flasks.

The collective doses during the preparation of the shipment in 2001 were larger than those received in 2000. However, no quantified data are available.

#### **Assessment of exposures of members of the public**

Dose assessments have been made for the critical groups of the population exposed during the transportation of the shipment in 2001. The calculated maximum dose of the critical group of residents living near the road from Petten to Den Helder is 0.014 microSv. Here an external dose rate at 2 m from the outside of the conveyance of 100 microSv/hour has been assumed.

The calculated maximum dose of the critical group of traffic participants (drivers and passengers) driving on the road during the shipment is 0,3 microSv.

## Shipments of radioactive waste

### A.1.4 Collecting of radioactive waste in the Netherlands

In according to national regulations, all radioactive waste released in the Netherlands should ultimately be shipped to the national site for intermediate storage of radioactive waste, which is owned by the national central organisation for collecting, conditioning and storage of radioactive waste (COVRA). The national site is located in Vlissingen-East, close to the Borssele NPP. COVRA collects radioactive waste using own trucks. During collecting, transfer of ownership of the radioactive waste takes place. Presently, COVRA is 100% state owned by the Ministry of Finance, represented by the Ministry of Environment. The former other share holders, the utilities of Borssele NPP, Dodewaard NPP and the national energy research centre (ECN) have transferred their shares to the State. For each of these three organisations a specific volume in the HABOG facility of COVRA has been reserved for future storage of their high-level waste. In 2004 is the HABOG facility in operation and will provide long-term interim storage of conditioned high-level heat generating waste in dry vaults. In addition, large and unconditioned, highly radioactive materials can be stored in shielded basements.

In addition to the HABOG facility, the COVRA site has also facilities for conditioning of radioactive waste, storage of radioactive bulk-material and interim storage of conditioned low- and intermediate level waste. In the latter facility 200-liter drums (stacked horizontally) and 1000- and 1500-liter (concrete) containers (vertical) are stored, see Figure A 3.

Presently, about 26 thousands of 200-l drums with different categories of waste are stored. Conditioned waste received from the nuclear power plants such as cemented ion-exchangers is packed in 1000-liter and 1500-liter containers. About 2000 of these containers are stored.

Presently, COVRA stores also four MTR-2 containers with irradiated fuel elements, which were shipped in 1999 and in 2000 from the HFR research reactor at Petten.

### A.1.5 Categories of waste shipments

There are two categories of waste shipments:

- Shipments of conditioned low- and mediumlevel wastes
- Shipments of unconditioned conditioned low- and mediumlevel wastes.

The waste is transported in industrial packages with in general low TI-values, because of the policy of COVRA to charge the consignors depending on the TI value of their packages. The TI value per shipment varies between 0 and 40.

In 2001, 677 packages with conditioned waste were transported in 80 shipments, mainly from the Borssele and Dodewaard NPP. In total 3199 packages with unconditioned waste (2366 packages with solid waste) were collected in 78 shipments by COVRA, mainly from research institutes.

Information on the consignors of the waste packages is presented the following paragraphs.

For an overview of the packages received in 2001 by COVRA, see Table A 5.

In 2001 in total 3876 colli were received by COVRA.

### A.1.6 Waste shipments from the Dodewaard NPP

In 2001, 11 shipments with 96 packages of conditioned waste were sent from Dodewaard NPP (GKN) to COVRA. These packages are 200-l drums (67) and concrete 1000-l containers (29).

In addition, COVRA collected in 2001, (in 2 shipments) 100-l drums (66) with solid unconditioned waste. These drums are supercompacted at COVRA and the pucks are cemented and stored in 200-l drums.

The annual number of shipments of waste from Dodewaard NPP is decreasing. In 1999, for example, 126 concrete containers (1000-l) with conditioned waste were sent to COVRA. Also 219 drums with compactible solid waste (12 of type 200-l drum and 207 of type 100-l drum) were sent to COVRA, including 30 radioactive spent sources in special containers. When the present phase of the decommissioning of Dodewaard NPP is completed, the annual number of waste shipments will further drop.

#### *A.1.7 Waste shipments from the Borssele NPP*

In 2001, 48 shipments with 560 packages of conditioned waste were sent from Borssele NPP (KCB) to COVRA. These packages are 200-l drums (507), 100-l drums (51) and concrete 1000-l containers (2). In addition, COVRA collected in 2001, (in 4 shipments) 100-l drums (154) with solid unconditioned waste. These drums are compacted at COVRA and stored in 200-l drums.

#### *A.1.8 Collecting unconditioned waste from laboratories and other sources*

In 2001, COVRA collected 2146, 100-l drums with unconditioned solid waste, such as dried sludge from water treatment systems and contaminated or activated material. From the laboratories various types of waste were collected. In total 753 packages with all kinds of liquid waste and 25 boxes with solid waste (frozen carcasses) were collected.

#### *A.1.9 TENORM waste and intermediate-level liquid waste*

In 2001, TENORM containing calcinate was shipped in 21 shipments to COVRA, each with one 20 ft IP-1 container. In addition 55 containers with medium-level liquid waste from radioisotope production were shipped to COVRA for conditioning and storage.

#### *A.1.10 Exposures of personnel of COVRA*

Annual collective dose of the COVRA personnel of 47 monitored workers received during 2001 is 20.6 man-mSv. This group also includes the drivers of COVRA. The highest 3-months individual dose of this group is 0.32 mSv. The total collective dose of others (non-radiological workers, visitors) is 0.299 man-mSv for 131 persons.

The transportation of shipments of radioactive waste is handled by a group of two drivers and personnel for monitoring and quality assurance of the waste packages received from the consignors. In general, there are two persons in the transport vehicle. They are also involved in the loading of the packages. Individual doses are about 1 mSv.

#### *A.1.11 Trends*

The annual number of shipments to COVRA has been increased from 130 (our last survey in 1998) to 158 in 2001. The main factor for this increase is the decommissioning of Dodewaard starting in 1997. Annual exposures of the drivers have not been increased.

It has been estimated that the annual exposure of the critical group of residents living close to the road to COVRA and exposed to all shipments is less than 0.2 microSv.



Figure A 3: Facility for interim storage of conditioned low- and intermediate level radioactive waste at COVRA

**Table A 5: Shipments of radioactive waste to COVRA during 2001**

Source	No. of Shipments	No. of colli	Type of collo / material
GKN	a)	66	100 liter drums/ solid
		67	200 liter drums/ (conditioned)
		29	1000 liter containers (conditioned)
	11		
KCB	a)	154	100 liter drums/solid
		51	100 liter geconditioned
		507	200 liter drums/ (conditioned)
		2	1000 liter containers (conditioned)
	48		
Covra collect	a)	2146	100 liter drums /solid
ECN	a)	55	Liquid Mo-production 1 and 2
Laboratories	a)	203	30 liter containers with organic liquids
„	a)	128	60 liter containers with organic liquids
„	a)	174	Container with liquid samples
„	a)	207	30 liter containers with anorganic liquid
„	a)	41	60 liter containers with anorganic liquid
„	a)	25	Coolboxes
TENORM	21	21	20 ft containers with calcinate
Total	80 + a)	3876	

a) These colli have been transported in 78 shipments. In 2001, COVRA collected 2417, 100-liter drums with solid waste.

## Shipments of uraniumhexafluoride

### Recent shipments

For the operation of the facility of URENCO in Almelo frequent shipments of uraniumhexafluoride ( $UF_6$ ) are carried out. Annually, about 125 shipments of natural  $UF_6$  in type 48Y industrial package are transported from the harbour of Rotterdam to Almelo by trucks. The 48Y packages (containers) arrive on trucks brought in by ship via a roll-on/ roll-off system (50 shipments per year) or arrive in ISO-freight containers (50 – 100 shipments per year). Incidentally, shipments of natural  $UF_6$  are also transported by road from France (less than 20 shipments). One shipment contains three 48Y containers, each with 12500 kg of  $UF_6$ . Annually about 330 of these containers with natural  $UF_6$  arrive in Almelo.

The depleted uranium left over from the enrichment process is also shipped as  $UF_6$  in 48 Y containers. Annually, about 280 of these containers return by road transport in about 100 shipments. Most of these shipments (> 90) are transported to the harbour of Rotterdam for further transport by ship (about 45 shipments by trucks and 45 to 90 shipments in ISO-freight containers). Incidentally, there are also shipments by road (10) to France

The enriched uranium is shipped as  $UF_6$  in containers. Depending on the degree of enrichment, these containers are type A or type B packages.

In general, the enriched  $UF_6$  is shipped by road in 30 B containers (type A-packages) with 6 containers per truck (shipment), each containing 2250 kg  $UF_6$ .

Annually, about 270 containers with enriched material are transported by road, to Rotterdam, France and Germany. In total about 55 shipments.

### Exposure of workers

The external dose rates of the 48 Y and 30 B containers is low (0.1 microSv/hour). For this reason the annual doses of the drivers and handlers are small in comparison with the doses received during shipments of other type of radioactive material.



## Shipments for distribution and supply of radioisotopes for medical, scientific and industrial application

### A.1.12 Shipments of radiopharmaceutica by Consignor A

#### Recent shipments

Consignor A transported 220 000 packages of radioisotopes from its production site in Petten. These packages are mostly type A packages, of which 55000 are A-packages with Tc-generators (Mo-99). Activity in the other 165 000 packages are more or less equally distributed over the radioisotopes Ga-67, I-131, I-123, In-111, Ir-192 and Tl-201. In addition ca 50000 packages with miscellaneous non-radioactive accessories are shipped.

Consignor A ships 50% of its packages to Germany (two vehicles in one day, five days a week), 11% to Belgium, 6% to France (five times a week) and 33% to Schiphol airport (twenty times a week). From Schiphol airport the packages are flown to many destinations. A part of inventory shipped to Schiphol is not loaded into an aircraft but is shipped by truck to a distribution centre (4%) in the city of Zaandam (twenty times a week). Also a large part of the shipments to the UK is transported by road. The cargo for all destinations is a mix of type A packages with Mo-generators, I-131, I-123, Ga-67 and In-111. Five times a week 90% of the Mo-generators for Germany returns to Petten after being used. Furthermore five times a week a truck with I-131 and Ir-192 sources travels from Schiphol airport to Petten. The shipment pattern of consignor A is illustrated in Figure A 4. The pie chart shows that the major part of the products of consignor A is exported.

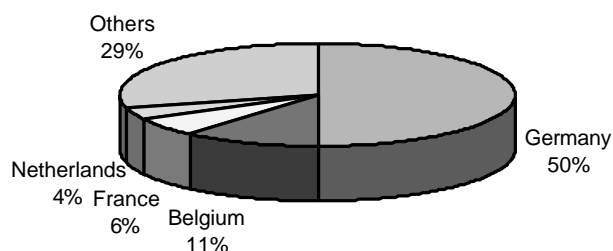

**Figure A 4: Shipping pattern of consignor A presented in percentages of the total number of packages shipped**

About 3400 journeys per year are made for company A, shipping a total activity of some 2500 multiples of A2. The activity in packages with Tc-generators is about 0.01 A2. Details of the different type of shipments are shown in Table A 6.

**Table A 6: Annual shipments of radiopharmaceutica by consignor A**

Traject <sup>(1)</sup>	Km/trip	colli/ journey	A <sub>2</sub> /journey	Journey/yr
P – Germany <sup>(2)</sup>	179	423	4.23	260
P – Belgium	179	93	0.93	260
P – France	179	51	0.51	260
P – Schiphol	63	67	0.67	1090
Schiphol-Zaandam	21	8	0.08	1040
Germany – P	179	95	0.18	260
Schiphol – P	63	21	1.02	260
<b>Total:</b>				<b>3430</b>

<sup>(1)</sup> P indicates location production center 50 kilometers North of Amsterdam.

<sup>(2)</sup> Two vehicles per day

In total about 220000 colli are shipped per year from Petten.

#### Exposures of workers

From an earlier EC study, completed in 1998 [6] it was known that workers involved in transportation of radionuclides for medical and industrial application are receiving higher annual doses than workers involved in other type of radioactive material transports. One of the reasons for these higher doses is large number of shipments and packages handled each year by these workers.

For shipments in 1997 of Consignor A it was found that the annual dose of their own drivers did not exceed 6 mSv/year, even with a high TI-load per vehicle. The measured exposure rates at the drivers' seat during shipment of high TI-load, such as shipments of Mo-generators, are in general less than 10 µSv/hour.

For shipments in 2001 the collective doses of the drivers of the company have been evaluated again. It has been found that the annual collective dose of these drivers was decreased to 30 man-mSv for annual shipments with a cumulative value of 52000 TI. This relatively low collective dose may be explained by the self-shielding of the large numbers of packages often stacked on several pallets varying from 200 to 350 or even more packages per vehicle.

At present there is no information available at NRG on the doses of Belgian and German drivers of the shipments to and from Petten.

In addition to the information on exposures of the drivers, also data is available on exposures of the workers who are daily involved in the packing and staging of packages in preparation of their shipment. The packages to be included for the different consignments are mechanically sorted. The sorted packages are manually stacked on lorries, which are shielded at three sides. The use of these lorries and other shielding arrangements around the mechanical sorting system, reduces the ambient radiation field in the working area to values of about 1 µSv/hour or slightly higher when a large number of packages are handled by the sorting system.

The collective doses of these workers in 2001 was 91 man-mSv for handling packages with a cumulative value of 168000 TI. The maximum individual dose of these workers was below 10 mSv. Data on the collective doses of drivers and handlers received in one week in 2001 are displayed in Figure A 5. The number of handlers is 15. The number of drivers involved varies per week.

**Recorded Transport Worker Doses arising from the shipment of radio-isotopes for medical use from Petten in 2001**

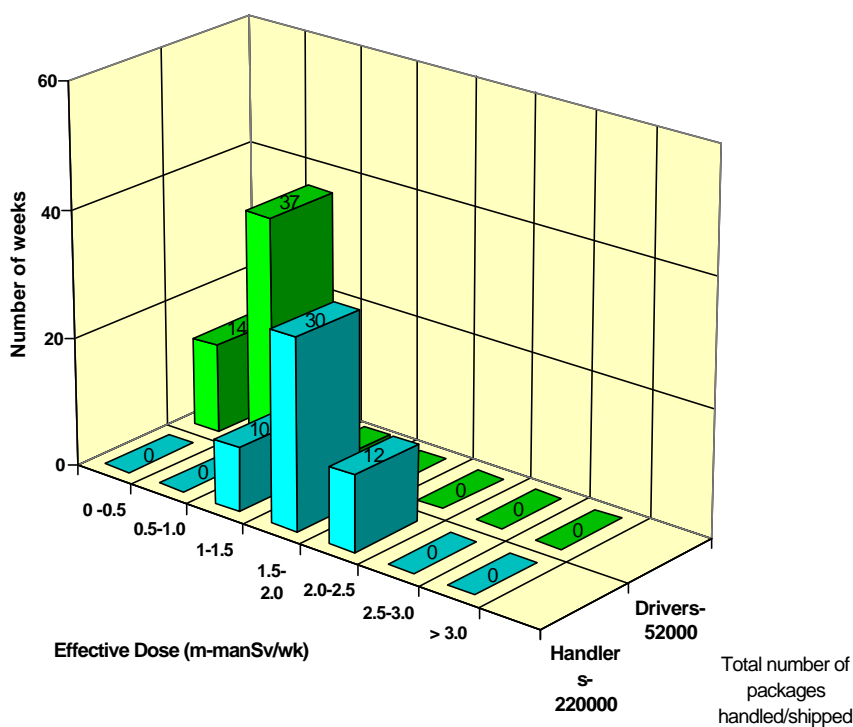

**Figure A 5: Collective doses per week due to handling and driving**

**Trends in exposures of workers**

In 2001 about 220,000 colli with radio-isotopes for medical use have been shipped from Petten. The total TI shipped is 168000, i.e. in average 0.76 TI per collo. The total annual collective dose in 2001 of personnel involved in packaging and storage of these colli is 91 man-mSv. This means that the average dose per TI handled is 0.54 man- $\mu$ Sv/ TI. This value is a factor two lower than the average dose of 0.8 – 0.9 man- $\mu$ Sv/ TI, reported for Consignor A in the 1998 EC study [6]. In 2002, the recorded annual collective dose of the group of 15 handlers was 94 man-mSv with a somewhat larger total TI handled. The maximum value recorded for the annual individual dose of the group of handlers is just below 10 mSv.

The collective dose of the drivers in 2001 is 30 man-mSv, which value is also lower than the value reported in 1998. Table A 7 shows a comparison between the data in 1997 and 2001.

**Table A 7: Trends in exposures of workers of consignor A**

Parameter	Value in 1997	Value in 2001
Cumulated TI-value handled	140000 TI	168000 TI
Recorded annual dose of handlers	125 man-mSv	91 man-mSv
Cumulated TI-value shipped	52000 TI	52000 TI
Recorded annual dose of drivers	41 man-mSv	30 man-mSv

### Exposures of members of the public

In the EC study of 1998 [6] also exposures to shipments of consignor A for members of the public have been evaluated. These exposures have been assessed from model calculations and monitored dose rates of vehicles. The predicted doses are (conservatively biased) upper estimates for hypothetical individuals (generally known as the critical group) such as a permanent group of residents living near, or commuters frequently travelling on roads used for the transport of large volumes of radioisotopes package shipments. The upper predicted annual doses for these groups are up to 10 - 20 microSv per year. However, the annual maximum dose for actual residents based on measured conveyance radiation levels at 2 m distance has been estimated as 1,6 microSv.

Because the number of annual shipment and shipment route have not been changed since 1998, also the same value of the maximum annual dose for members of the public is expected for the 2001 shipments.

### *A.1.13 Shipments of radiopharmaceutica by Consignor B*

#### Recent shipments

Consignor B distributes packages with radioisotopes for medical applications. Several shipments leaving daily from the distribution centre in the city of Eindhoven. A few packages are shipped daily from a distribution centre in the city of Zaandam. In addition to distribution within the Netherlands there are shipments of radioisotopes to other countries, by air and road. Most of the packages in these shipments are of Type A, with a low TI-value. This means that annual exposure of handlers and drivers is limited. The annual shipments are presented in Table A 8.

The packages shipped for export are all of Type A (UN 2915). Most of the packages shipped within the Netherlands are of Type-A. A small part (< 5%) of the packages is excepted packages (UN 2910).

**Table A 8: Shipment data for Consignor B**

Parameter	Value in 2001	Value in 2002
Annual number of transports within the Netherlands	8000	8000
Annual number of packages within the Netherlands	16000	16000
Annual number of international transports by road <sup>a)</sup>	605	1149
Annual number of packages shipped by road	7276	11325
Annual number of international shipments by air <sup>b)</sup>	1223	1482
Annual number of packages shipped by air	4374	4153

<sup>a)</sup> Shipments to Germany, Belgium, UK, France, Austria and Switzerland.

<sup>b)</sup> ca. 500 transports to Schiphol (Amsterdam) and Brussel airport each.

#### Exposures of workers

The exposures of the drivers are monitored by the radiation protection service of the TU of Eindhoven. Before departure of each shipment, the dose rate at the driver's seat is measured. Due to shipments of packages of low TI-values measured dose rates are very low. Exposure data for the staff involved in driving and handling the packages are presented in Table A 9.

**Table A 9: Exposure data for shipments of Consignor B**

Parameter	Value in 2001	Value in 2002
Total staff involved in shipments (handling, driving)	31	19
Effective number of staff [man-years]	23	16.5
Collective dose of the staff [man-mSv]	9.2	10
Average dose per man-year [man-mSv/man-years]	0.40	0.6
Maximum individual annual dose [mSv]	2.1	2.9



**Table A 10: Exposures of workers involved in the preparation of irradiated fuel shipments from the Dodewaard NPP during 2001**

Transport	No.	Operators involved in loading	Personnel involved in cleaning	Ext. Transport personnel	Monitoring personnel	Total operation
25 January	94	1,28 man mSv	0,89 man mSv	0,55 man mSv	0,11 man mSv	2,83 man mSv
1 March	95	1,26 man mSv	0,23 man mSv	0,37 man mSv	0,08 man mSv	1,94 man mSv
9 May	96	0,55 man mSv	0,34 man mSv	0,10 man mSv	0,10 man mSv	1,09 man mSv
12 June	97	0,52 man mSv	0,25 man mSv	0,16 man mSv	0,10 man mSv	1,03 man mSv
5 September	98	0,46 man mSv	0,41 man mSv	0,08 man mSv	0,09 man mSv	1,04 man mSv
17 October	99	0,28 man mSv	0,46 man mSv	0,25 man mSv	0,09 man mSv	1,08 man mSv
28 November	100	0,48 man mSv	0,26 man mSv	0,32 man mSv	0,15 man mSv	1,21 man mSv
<i>Average doses</i>		<i>0,69 man mSv</i>	<i>0,41 man mSv</i>	<i>0,26 man mSv</i>	<i>0,10 man mSv</i>	<i>1,46 man mSv</i>

**Table A 11: Exposures of workers involved in the preparation of irradiated fuel shipments from the Dodewaard NPP during 2002**

Transport	No.	Operators involved in loading	Personnel involved in cleaning	Ext. Transport personnel	Monitoring personnel	Total operation
19 February	101	0,54 man mSv	0,25 man mSv	0,25 man mSv	0,06 man mSv	1,10 man mSv
3 April	102	0,18 man mSv	0,21 man mSv	0,28 man mSv	0,24 man mSv	0,91 man mSv
15 May	103	0,17 man mSv	0,14 man mSv	0,16 man mSv	0,12 man mSv	0,59 man mSv
19 June	104	0,49 man mSv	0,14 man mSv	0,17 man mSv	0,05 man mSv	0,85 man mSv
4 September	105	0,31 man mSv	0,08 man mSv	0,24 man mSv	0,08 man mSv	0,71 man mSv
8 October	106	0,29 man mSv	0,03 man mSv	0,15 man mSv	0,09 man mSv	0,56 man mSv
5 November	107	0,26 man mSv	0,13 man mSv	0,14 man mSv	0,04 man mSv	0,57 man mSv
10 December	108	0,14 man mSv	0,17 man mSv	0,20 man mSv	0,20 man mSv	0,71 man mSv
<i>Average doses</i>		<i>0,30 man mSv</i>	<i>0,14 man mSv</i>	<i>0,20 man mSv</i>	<i>0,11 man mSv</i>	<i>0,75man mSv</i>

During the transport operations in 2001 and 2002, no notifiable surface contamination was found on the empty NTL-15 flasks from the UK after arrival at Dodewaard NPP. During the inspections of the irradiated fuel shipments in 2001 and 2002 also no notifiable surface contamination was found.

**APPENDIX B: Completed questionnaire for the Netherlands (2001)**

**Survey on the Type and Magnitude of Radioactive Material Shipments in the Public Domain of EU Member States and Applicant Countries: Part I**

Reporting Country: ....Netherlands.....  
 Reporting Year: .....2001.....

Radioactive Material	Annual transport volume		Predominant transport mode			
	Number of Shipments per Year	Number of Packages per Year	Road	Rail	Air	Sea
<b>Fuel Cycle Material:</b>						
- Irradiated fuel assemblies, fuel pins (UO <sub>2</sub> , MOX)	14	28	!	!		!
- Non-irradiated fuel assemblies, fuel pins (UO <sub>2</sub> , MOX)	-	-				
- Uranium/thorium ore	0	0				
- Pre-fuel material (UOC, U <sub>3</sub> O <sub>8</sub> , UO <sub>2</sub> , MOX, pellets etc.)	0	0				
- Uranium Hexafluoride (UF <sub>6</sub> )	280	880	!			!
- Vitrified radioactive waste	0	0				
- Low-/intermediate-level radioactive waste (LLW/ILW)	65	876	!			
- Unloaded (empty) flasks	13	25	!	!		!
- Others (samples, components, monitoring equipment etc.)	-	-				
<b>Radioisotope Supply and Distribution:</b>						
- Type B packages	-	-				
- Type A packages	13300	286000	!		!	
- Excepted packages	400	800	!			
- Others	-	-				



**Survey on the Type and Magnitude of Radioactive Material Shipments in the Public Domain of EU Member States and Applicant Countries: Part I (Continued)**

	Radioactive Material	Annual transport volume		Predominant transport mode			
		Number of Shipments per Year	Number of Packages per Year	Road	Rail	Air	Sea
	<b><u>Radiation Sources:</u></b>						
	- Radiographic radiation sources	-	-				
	- Nuclear density/portable gauging devices	60	60	!			
	- Others	-	-				
	<b><u>Non-nuclear Radioactive Wastes</u></b>						
	- Medical / research wastes	72	2979	!			
	- Industrial wastes	21	21	!			
	- Others (specify)	-	-				
	<b><u>Consumer Products</u></b>						
	- Smoke detectors	-	-				
	- Radioluminescent products	-	-				
	- Lighting products	-	-				
	- Others (specify)						
X	Data available , but yet to be analysed						

The Netherlands, RAM shipments in 2001



**Survey of Occupational and Public Radiation Exposures arising from Radioactive Material Package Shipments in EU Member States and Applicant Countries: Part II**

Reporting Country: .....Netherlands.....  
 Reporting Year: .....2001.....

	Transport Operations	Annual Individual effective Dose per year				Remarks
		Transport Workers [milliSv]		Public (Critical group)[microSv]		
		Avg.	min./max.	Avg.	Min./max.	
<b><u>Nuclear Fuel Cycle</u></b>						
	- Road	-	-/2	< 1	0.08/1.8	
	- Rail	-	-	< 1	0.03/19	
	- Air	-	-			
	- Sea	-	-			
<b><u>Radioisotope Supply and Distribution</u></b>						
	- Road	6	0.1/10	1.6	-/20	
	- Rail	-	-			
	- Air	-	-			
<b><u>Radiation Sources</u></b>						
	- Radiography	-	-			
	- Nuclear density/gauging devices	-	-			
<b><u>Non-nuclear Wastes</u></b>						
	- Medical/research/industry (specify)	1	1	-	-/0.2	
<b><u>Consumer Products</u></b>						
	Road/Rail/Air/Sea (specify)	-	-	-	-	
If available give additional details, references etc. under remarks or on a separate page						

## Annex 5

### **“STATISTICS ON THE TRANSPORT OF RADIOACTIVE MATERIALS IN FRANCE AND STATISTICAL ANALYSES”**

EC Contract N° 4.1020/D/01-003 (DG TREN)

Final Report

December 2002

M.T. Lizot (1), G. Sert(1), J. Brenot (1), K. Ben Ouaghrem (1), M. Valero (1)  
S. Lopicard (2), T. Schneider (2)

(1) Institut de Radioprotection et de Sûreté Nucléaire (IRSN)  
BP 17, F-92265 Fontenay-aux-Roses Cedex, France

(2) CEPN  
BP 48, F-92263 Fontenay-aux-Roses Cedex, France

## TABLE OF CONTENTS

Abstract

Introduction

1. Data collection

1.1 French transport flow in 1997

1.2 Occupational doses

1.3 Dose to the public

2. Data Analyses

2.1 Transport flows in 1997

2.2 Occupational doses for 1997 and 2000

2.3 Doses to the public

3. Conclusion

4. References

Annex 1 : Statistics on radioactive material transport flows of year 1997 reported to IRSN

Annex 2 : Modified tables of the report given in annex 1

Annex 3 : Questionnaire sent to the radiographers

Annex 4 : Report from CEPN on doses to the public

## Abstract

In 1997, French carriers and consignors have declared 345 000 packages transported through 31 000 transports. The number of transports of gammagraphs, gamma density gauges and lead analysers were underestimated and the total number of packages transported could be 700 000 according to our estimation taking into account a 2002 questionnaire sent to the main users of gammagraphs. The work performed has highlighted that a significant number of users of packages for civil industries had been forgotten; in addition due to a new regulation concerning the trade of ancient lodgings (ministerial order dated 12<sup>th</sup> of july 1999 requiring mandatory check of presence of lead in wall paintings) a new category of transport now exists which corresponds to an annual flux of 260 000 transports approximately.

The transport mode was quite well populated (0.01% unspecified only), 83.3% of packages are transported by road, 7.7% of packages are transported by rail, 6.9% of packages are transported by air, and 2.1% of packages are transported by sea.

For the transported packages, 30% are type A packages, 14% are industrial packages, 46% are excepted packages, and 7% are type B packages. In 0.4% of cases, the package type has not been declared.

The most frequent package transports are, in decreasing order, excepted packages by road (44%), type A packages transported by road (26%), type B packages by road (7%), type A packages by air (6%), industrial packages by rail (6%), industrial packages by road (6%), excepted packages by air (2%), and industrial packages by sea (2%).

The material category is not well populated, 68% of transports and of packages are declared as unspecified. Nevertheless, it appears that the number of LSA I material packages represents 32% of the specified packages. Few LSA II (0.2%) are listed and even less LSA III. The transport of special source packages (gammagraphs and gamma density gauges) represents 53% of the specified packages. Transports for medical industry represents 4% of the total number of transports, transports for the nuclear fuel cycle represent 1% and transports for civil industry and nuclear research represents 95% of the total number of transport.

The occupational doses are 37.5 mSv/year for the transport of radiopharmaceutics, 4 mSv/year for the transport of the nuclear fuel cycle, 0.7 mSv/year for the transports for the civil industry and 2 mSv/year for the transports for the civil and nuclear research. The study indicates that for year 2002 the maximal dose for the transport of radiopharmaceutics is 17 mSv/year. All the doses are less than or in few cases of the order of magnitude of the actual limits of doses recommended by the European directive 96/29 which set a limit on effective dose for workers of 20 mSv/y averaged over five consecutive years.

Further improvements in the radiopharmaceutics transport aiming at reducing the occupational dose are recommended; they would involve a study of the drivers working conditions and an assessment of their protections.

To improve the knowledge of the doses received by the public, a systematic study would be necessary, and particularly dealing with the areas near the nuclear sites or along the ways frequently used by the conveyances. Such studies are expected to be included in the RPP of the operators.

The associated annual collective dose for the public is about 5 man.Sv mainly due to the transport of radiopharmaceutics and to the transport for civil industry and the maximum public exposure associated to a given scenario is 200  $\mu$ Sv/year.

## INTRODUCTION

This document presents the work carried out with the prime objective to describe the transport flow in France in 1997, to know the associated occupational doses and to estimate the associated doses received by the public. This paper deals with the transport of radiopharmaceutics and the transport related to the nuclear fuel cycle, the civil industry and the civil nuclear research. This work was undertaken within a multi-lateral research project performed on behalf of the European Commission, Directorate-General Energy and Transport (EC Contract No. 4.1020/D/01-003. The project entitled “**Statistics on the transport of radioactive materials and statistical analyses**”) is co-ordinated by the National Radiological Protection Board (NRPB). IRSN/DSMR was responsible for the management of the work and for the collection and compilation of the transport flows and for the evaluation of the civil industry occupational doses. CEPN, subcontractor of IRSN was in charge of the evaluation of the doses for the public and IRSN/DPHD was in charge of the collection of the doses to workers involved in the transport of radioactive material.

## 1. DATA COLLECTION

### 1.1 French transport flow in 1997

A request for “Declaration of radioactive material transport flows for the year 1997” was sent to 56 French companies. These 56 companies represented all the companies known by IRSN to transport radioactive materials. See appendix 1 of annex 1 the questionnaire and appendix 4 of annex 1 for the list of these companies. The following informations were requested :

- Material
- Location of departure
- Location of arrival
- Transport mode
- Type of package
- Name of package
- Number of transports (number of transports performed between the place of departure and the place of arrival)
- Number of packages (total number of packages transported during the x above-mentioned transports)
- Weight (total weight transported during the x transports)
- Fissile weight (total fissile weight transported during the x transports)
- Total activity
- Material category
- Use of the material

Among the 56 companies contacted, 30 returned a flow description. Among the 26 companies that didn't reply some are subcontractors of others; these missing replies thus do not affect the overall result. The companies for which the flow was not reported at all should not be among the most important regarding the quantities transported. However the results should be considered with care, due to the non-exhaustiveness of the transports reported and because certain transports may have been reported by two different companies and thus counted twice.

This work based on the study made on the analysis of radioactive material transport flows in 1997 concerning French companies has been completed to identify some unspecified datas. Moreover some data have been added to give a scope of the 2002 flows of gammagraphs, lead analysers and gamma density gauges, which, in the mean time, were found to represent a great number of transports.

The original 1997 report is given in annex 1 and the modified tables are presented in annex 2. The main results are recalled in the following paragraphs.

One transport corresponds to one consignment between one consignor and one consignee. One transport may involve several modes of transport (combination: Road + Air or Road + Sea,...). This definition has been chosen because the consignor gives the most relevant and most precise data.

## 1.2 Occupational doses

The doses of workers were collected by two ways.

The first way is using the national worker individual dose database of IRSN. For the workers with individual dosimetry the dose recorded must be sent to IRSN which must keep records during the whole life of the workers.

Some workers in nuclear facilities may also be involved in operations not related to transport. Their dose is not only due to transport. A questionnaire was sent to transport companies in order to distinguish the workers not only involved in transport and to obtain their doses.

Occupational doses are available for 1997 and 2000.

For the gammagraphs, a sample survey on radiographer doses has been made in order to estimate the rate of the transport dose on the total worker dose.

## 1.3 Dose for public

Data on transport flows in France for the year 1997 were considered. Complementary information were also taken from the year 2000 datas. Assessments were performed separately for the different types of transported materials, namely:

- Radioactive materials being a matter of the nuclear fuel cycle,
- Radioactive materials used for medical purposes,
- Radioactive materials used in civil industry,
- Radioactive materials used civil nuclear research.

For practical reasons relating to the lack of information on the available data on transport flows in France, it was not always possible to clearly differentiate between these four major categories, and some overlapping might have occurred in the calculations by reporting the same transport several times in different categories, resulting in a general overestimation of the collective doses.

Complementarily, individual doses of the public have been estimated for some relevant transport types, considering different hypothetical scenarios of exposure.

## 2. ANALYSES OF DATAS

### 2.1 Transport flow in 1997

The survey given in annex 1 inventoried 345,448 transported packages for 1997 on the French territory. The previous assessment performed about the transport fluxes declared in 1993, resulted in a value of 300,000 packages transported each year. The rank order was the same and the number of packages actually transported each year in France was estimated higher but not exceeding 400,000 packages. However a recent survey about transport for civil industry and research, described in paragraph 2.1.3, suggests that a more realistic figure would be in the range of 700,000 packages transported per year in France. The inventoried packages include exports, imports, domestic transports, but not transits.

#### 2.1.1 Analysis per mode of transport

Table 1 presents the number of transports and the number of packages per transport mode. The transport mode was quite well populated (0.01% unspecified only), 91.4% of packages are transported by road, which is the most frequent transport mode, 8.5% of packages are transported by rail, 7.6% of packages are transported by air, and 2.3% of packages are transported by sea.

Table 1. Number of transports and transported packages per transport mode

Mode of transport & combination	Number of transports (rounded)	Number of packages (rounded)	Number of transports %	Number of packages %
Road only	405 000	60 000	98.99	83.6
Rail only	910	46000	0.22	6.41
Sea	21	800	0.01	0.11
Air + Road	2 700	55 000	0.66	7.60
Rail + Sea	220	15 000	0.05	2.04
Rail + Road	130	380	0.03	0.05
Sea + Road	130	1 200	0.03	0.17
Unspecified	1	100	0.00	0.01
<b>Total :</b>	<b>410 000</b>	<b>720 000</b>	<b>100</b>	<b>100,00</b>
<b>Sub sum Road</b>	<b>410 000</b>	<b>66 000</b>	<b>99.7</b>	<b>91.4</b>
<b>Rail</b>	<b>1 200</b>	<b>61 000</b>	<b>0.3</b>	<b>8.5</b>
<b>Air</b>	<b>2 700</b>	<b>55 000</b>	<b>0.6</b>	<b>7.6</b>
<b>Sea</b>	<b>370</b>	<b>17 000</b>	<b>0.1</b>	<b>2.3</b>

For the transported packages, 30% are type A packages, 14% are industrial packages, 46% are excepted packages, and 7% are type B packages. In 0.4% of cases, the package type is not specified.

#### 2.1.2 Analysis per type of package and mode of transport

Table 2 presents the number of transports and the number of packages per type of package. The most frequent package transports are, in decreasing order, excepted packages by road (44%), type A packages transported by road (26%), type B packages by road (7%), type A packages by air (6%), industrial packages by rail (6%), industrial packages by road (6%), excepted packages by air (2%), and industrial packages by sea (2%).

Table 2. Number of transports and transported packages per type of package

Mode of transport	Type of package											
	B	A	AF	I	i1	i2	i3	i + A	E	Un-specified	Bulk	Total
<b>Road</b>	53131	176652	10806	16921	8955	12144	2531	1598	320296	2601	338	605973
<b>Rail</b>	400	91		8737	211	3415	33572	31				46457
<b>Sea</b>	14	292		495								801
<b>Road + air</b>	202	40484		7	7				14330	19		55049
<b>Rail + sea</b>	78	950		12972	684				82			14766
<b>Rail + road</b>	7			374								381
<b>Road + sea</b>	7	177	216	123	675	15			15			1228
<b>Unspecified</b>										102		102
<b>Total :</b>	<b>53839</b>	<b>218646</b>	<b>11022</b>	<b>39629</b>	<b>10532</b>	<b>15574</b>	<b>36103</b>	<b>1629</b>	<b>334723</b>	<b>2722</b>	<b>338</b>	<b>724757</b>

The following list specifies the various types of packages selected for this survey (see Annex 1 appendix 3 for the exhaustive list of replies), with the nomenclature used in the database specified in brackets :

- Excepted (**E**)
- Industrial type I (**I1**)
- Industrial type II (**I2**)
- Industrial type III (**I3**)
- Industrial (**I**)
- Excepted + industrial (**E + I**)
- Type A (**A**)
- Type A + excepted (**A + E**)



Type B (**B**)  
 Industrial + type A (**I + A**)  
 Fissile industrial package (**AF**)  
 Fissile industrial + fissile type A (**IF + AF**)  
 Bulk  
 Unspecified (**Unspecified**)

### 2.1.3 Analysis per type of material category

The material category is not well populated in the database, 68% of transports and packages are declared as unspecified. Nevertheless, it appears that the number of LSA I material packages represents 31% of the specified packages. Few LSA II (2%) are listed and even less LSA III (0.1%). Special form source packages represents 53% of the specified packages (mainly gammagraphs and gamma density gauges).

### 2.1.4 Analysis per type of use

Table 3 specifies the number of transports and the number of packages per economic sector of use.

Table 3. Number of transports and transported packages per economic sector of use of the material

Use type	Number of Transports (rounded)	Number of packages (rounded)	Number of transports %	Number of packages %
<b>Medical</b>	16 000	200 000	4	27.4
<b>Civil industry</b>	380 000	380 000	93	52.4
<b>Nuclear fuel cycle</b>	5 800	120 000	1	16.7
<b>Civil and nuclear research</b>	7 200	19 000	1.8	2.7
<b>Unspecified</b>	790	6 000	0.2	0.8
<b>Total :</b>	410 000	720 000	100.00	100.00

#### 2.1.4.1 Radiopharmaceutics

Shipments of radionuclides for medical are numerous in France. They originate from the operation of one large and a few smaller production facilities. According to table 3 radiopharmaceutics represent 16 443 transports (4% of total number of transports) for 198 597 packages (27% of the total number of packages). The vast majority are type A packages (70%). The main producer in France is SCHERING CIS-BIO. One part of the packages is carried directly by road (60%) to the users and the other part is carried to the airports ( $\approx$ 40%) for export. SCHERING CIS-BIO commercialises three types of products: technetium 99 generators, radiopharmaceuticals and foreign radiopharmaceuticals. Two carrier companies are used; one for delivery in Paris suburbs (SITA) and the other in provinces (Transroute Santé).

#### 2.1.4.2 Nuclear fuel cycle

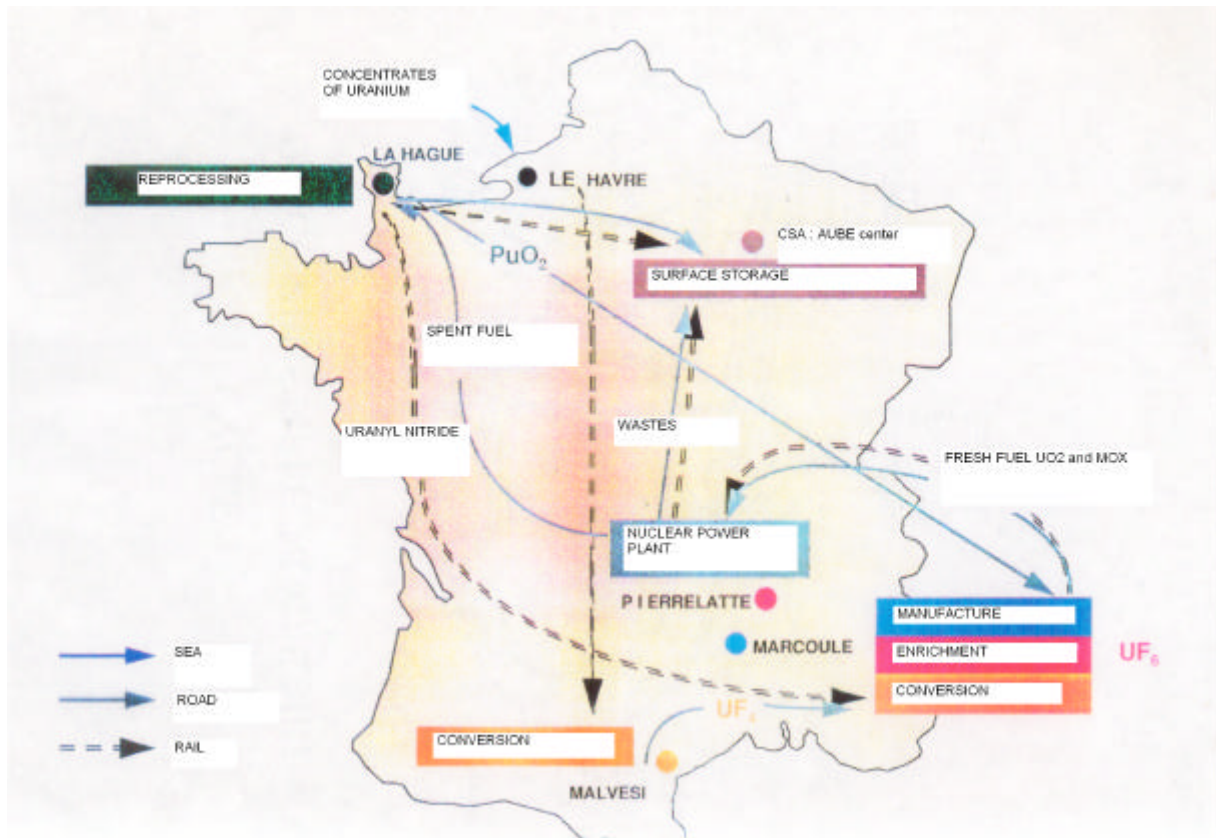

Figure 1 : Nuclear fuel cycle in France.

Comurhex-Malvesi, in the Languedoc region of France receives, stores and converts uranium concentrates into uranium tetrafluoride ( $UF_4$ ), the first stage of the uranium conversion process. The purpose of uranium conversion is to get it a suitable chemical form for the next stage of the fuel cycle, enrichment.

The second stage of conversion, from  $UF_4$  to  $UF_6$  (uranium hexafluoride) is accomplished at the COMURHEX-Pierrelatte plant. The natural material and the depleted material are transported in 48Y containers and the enriched material is transported in type 30 B containers. Approximately 40% of Comurhex's production is exported.

COGEMA-Pierrelatte facility converts uranyl nitrate produced by spent fuel reprocessing into uranium oxide and defluorinates depleted uranium produced by enrichment operations.

In France, uranium is enriched at EURODIF's Georges Besse plant in Pierrelatte in the Drôme department. Uranium enrichment consists in increasing the uranium 235 concentration of 0.72 % in natural uranium to concentrations of 3 to 5% in mass. Ninety percent of the nuclear power plants currently in operation use this type of enriched uranium. The MELOX plant at the Marcoule site in the Gard department of France has been fabricating MOX fuel assemblies for nuclear power plants since 1995. Plutonium is a by-product of reprocessing. The plant has recycled more than 40 metric tons of plutonium into fuel since it was built.



EURODIF's Georges-Besse enrichment plant

The FBFC plant at Romans in the Isere department of France fabricates  $UO_2$  fuel assemblies for the nuclear power plant.

The COGEMA-La Hague site, located on the western tip of the Cotentin Peninsula in Normandy, reprocesses spent power reactor fuel to recycle reusable energy materials-uranium and plutonium-and to condition the waste into suitable final form. Following a series of mechanical and chemical operations, 96% of the uranium contained in a fuel element is separated and conditioned in the form of uranium nitrate, and 1% as plutonium is conditioned as plutonium oxide powder. In France irradiated fuels are carried mainly by rail. Road transport is used only between some nuclear power plants and the next railway station and between the rail terminal of Valognes and the reprocessing plant of La Hague. About 200 spent fuel packages arrive at La Hague every year.

The by-products of reprocessing (activated metal scrap and fission products) are non-reusable radioactive wastes that are conditioned into suitable final form for disposal.

The aim of disposal is to isolate the radioactive materials from the environment during the time needed for radioactivity to decrease. The ANDRA Manche Centre, in operation from 1969 to 1994, has now been replaced by the Centre of the Aube. This Centre has ensured, since its opening on the 13th January 1992, the confinement of short-lived LLWs and MLWs, generated in France by the activities of production of electricity, research, industry and medical activities. 116 trucks containing waste packages were transited via the Brienne-le-Château railway terminal, requiring 330 road turnarounds between the terminal and the centre. Moreover, 1025 vehicles arrived directly at the centre from the production site, averaging out at 6 vehicles per day.



*Packages*



*Structures*



*Environment*



*Figure 3 : Waste package unloading at the Brienne-le-Château terminal*

According to table 3 about 1% of the total shipments (17% of the total packages) is associated with the nuclear fuel cycle: from the mine to conversion and fuel fabrication plants, from there to nuclear power plants, from there to reprocessing facilities, and to waste disposal facilities. Shipments are made by train, truck, boat or airplane.

### 2.1.4.3 Civil industry and nuclear research

#### 2.1.4.3.1 Civil industry

Radiation sources are transported for technical services to industrial sites. These transports represent 93% of the total number of transports and 52% of the total number of packages.

The sources are used for radiographic gauging (welding), moisture/density gauging and testing of lead paintings. Sources contain  $^{137}\text{Cs}$ ,  $^{192}\text{Ir}$  or  $^{60}\text{Co}$  and  $^{241}\text{Am}$ .

The French Package Data Base [13] gives 623 gammagraphs declared by the French owners. Within the 623 gammagraphs in France, only 476 have been declared in transport, among which 356 belong to radiographic service companies.

The work performed has highlighted that a significant number of users of packages for civil industries had been forgotten; in addition due to a new regulation concerning the trade of ancient lodgings (ministerial order dated 12<sup>th</sup> of July 1999 requiring mandatory check of presence of lead in wall paintings) a new category of transport now exists which corresponds to an annual flux of 260 000 transports approximately.

The mean number of movements per year for a gammagraph carried for radiography is about 150 transports/year from the data provided by 3 of the main companies as shown in Table 5. The number of movements of those belonging to other companies is 4 transports/year for maintenance. It gives an average 50.000 gammagraph transports per year.

For gamma gauges (Type A), we estimate 4 movements per week during 30 weeks for about 600 transported gamma gauges. It gives an average 70.000 gamma gauges transports per year.

For lead analysers (Excepted package), we estimate about 5 movements per day, 5 days per week during 30 weeks for about 350 transported lead analysers. It gives an average of 260.000 movements per year.

Such an estimation gives 380.000 transports per year essentially by road for civil industry.

Table 4 : Number of gammagraph models used in France

Model	Certificate	Packages declared in France in 2002
GAM 80-120 (Cs137 – Ir192)	F/137/B(U)	541
GR 30-50 (Cs 137)	F/213/B(U)	53
GAM 400 (Cs 137)	F/217/B(U)	29
GMA 2500 (Co 60)	F/112/B(U)	
	<b>Total</b>	623 (476 declared in transport)



Figure 4 : GAM 80

Table 5 : Number of movements and number of gammagraphs for the 3 main companies

	AGRETEST	PLS	IS
Number of movements by Road (France)	1186	2400	12353
Number of movements by Road and Air (abroad)			22
Number of movements for radiography	800	2200	12213
Number of movements for maintenance	14	100	140
Travelled distance by 1 gammagraph / year in km	14000	12000	115000
Number of packages belonging to the company and actually transported	7	20	74

Table 6. Estimation of the number of radioactive transports for civil industry

	Type	Estimation of number of packages used in transport	Estimation of the total number of movements per year
<b>Gammagraphs</b>	B	476	50 000
<b>Gamma density gauges</b>	A	600	70 000
<b>Lead analyzers</b>	E	350	260 000
		<b>Total :</b>	380 000



Figure 5 : Lead analysers (excepted package) density

gauges (type A, yellow II, TI = 0.2)



Figure 6 : Gamma

### 2.1.4.3.2 Civil and nuclear research

Transports for civil and nuclear research represents 2% of the total number of transports and 3% of the packages according to table 3. These transports comprise transport of fresh, irradiated MTR and transport of wastes.

### 2.2 Occupational doses for 1997 and 2000

Packages containing radioactive materials emit ionizing radiations out of the package. As part of the external dose rate control, packages and overpacks are assigned to one of the three categories, I-White, II-Yellow or III-Yellow according to the maximum surface dose rate and the transport index as presented in table 7.

Table 7 : Maximum dose rate and TI for package categories

<u>Package category</u>	<u>Maximum surface dose rate</u> (mSv/h)	<u>Maximum TI</u>
<b>Excepted</b>	≤ 0.005	
<b>I – White</b>	≤ 0.005	0
<b>II – Yellow</b>	0.005 to 0.5	0 to 1
<b>III – Yellow</b>	0.5 to 2.0	1 to 10
<b>III - Yellow + exclusive use</b>	2 to 10.0	> 10

The 0.005 mSv/h surface dose rate was based on a 20 hours contact with undeveloped film giving rise to a maximum dose of 0.1 mSv. The 2 mSv/h value appeared in the early US regulations; its original justification was that a worker, carrying packages in contact 30 minutes each day would not receive a dose exceeding 1 mSv a day. This was acceptable in the 1940s but unacceptable today.

Segregation and stowage requirements form part of external radiation control. Radioactive materials must be segregated from workers, and at distances which would not cause doses to workers in excess of 5 mSv/year.

The accumulation of packages in a freight container or on a conveyance is controlled by a limitation on the sum of the transport indices and by limitations on the dose rate outside the conveyance.

### 2.2.1 Radiopharmaceutics

The transport of radiopharmaceutics include four distinct operations :

- packaging and loading,
- transport by road to the users, railway stations or airports,
- intermediate transport and storage in transit
- delivery

The annual worker doses are presented in table 8.

In 1997 two carrier companies are used; one for the transport in Paris suburbs (SITA) and the other for the French regions and Europe (Transroute santé).

Table 8 : Annual worker dose,

Name of the company	Year	Number of monitored workers	Film Position	Maximum dose mSv/year	Average dose mSv/year
SITA	1997	13	Thorax	7.1	3.87
		12	Wrist	4	2.25
	2000	11	Thorax	16.2	8.09
		10	Wrist	16.4	11.3
TRANSROUTE SANTE	1997	67	Thorax	37.5	11.41
	2000	9 (and 13 subcontractors)	Thorax	17.05	4.89
FEDEX (airport)	2002			14[12]*	

\*from calculation



Radionuclide packages, for medical use, are regularly dispatched by road transport in France. Packages are small and light weighted. Drivers manually handle these packages during loading and unloading, which accounts for a large part of the annual dose. Packages are carried in large numbers, up to 100 at the start of routing. Vehicles are 3 to 5 m long for consignment transport index comprised between 5 and 50. For the drivers, the annual doses is near the annual dose limit (20 mSv) and no reduction has appeared in the time (except for SITA) .

Doses received during intermediate storage in airport transit areas (for instance FEDEX) are of the same order of magnitude as doses to the drivers but the recording of these doses has just begun.

### 2.2.2 Nuclear fuel cycle and nuclear research

Significantly lower transport worker doses have been found to prevail in transport operations arising from the nuclear fuel cycle. Result are presented in table 9. Only the transport companies are taken into account. In the nuclear fuel cycle, loading and unloading operations are performed by workers who belong to the consignor or consignee site and who are not only involved in transport operations. In the results below, the transport worker include personnel involved in transport operations such as truck drivers (CELESTIN, LEMARECHAL, DERET, BAUDRY), train drivers (SNCF), marshalling yard inspectors (SNCF), handlers (workers of Valognes) and health physicists (workers of Valognes).

Irradiated fuel are carried mainly by rail. Road transport is used only between the nuclear power plant and the closest railway station and between the rail terminal of Valognes and the reprocessing plant of La Hague. The workers of Valognes are involved in transport of spent fuel to be reprocessed, in the transport of vitrified high level radioactive waste and in transport of uranyl nitride tank. Their maximal dose is about 4 mSv/year which represents the maximal annual dose for the transport workers of the nuclear fuel cycle.

For the non irradiated nuclear fuel, movements consist of imports of uranium ore concentrates and transfers or exports of uranium tetrafluoride and uranium hexafluoride and transports of fresh fuel assemblies to the nuclear power plants. Transports are performed by road and by rail.

For waste and surface contaminated objects, transport are performed for the nuclear fuel cycle and the nuclear research centres by some few companies by road and by train and the annual doses are below 2 mSv/year (BAUDRY and DERET and SNCF).

The railway worker of SNCF receives a dose below 1 mSv/year.

Table 9 : Annual worker dose

Company	Year	Number of monitored workers	Film location	Maximal dose mSv/year	Average dose mSv/year
SNCF	1997	127	Thorax	0	0
COGEMA Valognes	1997		Thorax	About 4*	
	2000		Thorax	4*	
LE MARECHAL	1997	47	Thorax	0.4	0.26
CELESTIN	1997	35	Thorax	1.05	0.43
	2000	23	Thorax	0.4	0.33
DERET	1997	11	Thorax	2	1.3
	2000	11	Thorax	0	0
TRANSNUCLEAIRE	1997	27	Thorax	0.3	0.25
	2000	68	Thorax	0.25	0.25
BAUDRY	2000	3	Thorax	1.9	1.9

### 2.2.3 Civil industry

A sample survey on radiographer doses has been made in order to identify the part of the transport dose in the total worker dose. Two different dosimetric follow-up have been made within 4 of the most important radiographer companies and the French supplier CEGELEC :

Table 10 : Dosimetric follow up type used for the 4 main companies

Follow-up	Distribution	Company
<b>Personal passive dosimeter</b>	1 fixed inside the vehicle (transport) 1 wearied by the worker (radiographic work +	1 worker for AGRETEST, 1 worker for PLS CONTROLE,

	transport)	2 workers for INSTITUT DE SOUDURE, 1 worker for CEGELEC
<b>DOSICARD</b>	1 in the vehicle (transport)	1 worker for CEGELEC

Table 11 : Results of the study and annual transport dose estimation for radiographer

Company	Exposure time	Vehicle dose	Personal dose	Maximal total dose mSv/year (transport + radiography)	Estimation of the transport Maximal dose mSv/an
AGRETEST PORCIEU	40 days	< 0.1 mSv	0.25 mSv	3.2	< 0.6
PLS CONTROLE	60 days	< 0.1 mSv	0.60 mSv	16.2	< 0.4
INSTITUT DE SOUDURE	35 days	< 0.1 mSv	0.30 mSv	16.4	< 0.7

The dose measured by the dosimetric film in the vehicle during the exposure time comprised between 40 and 60 days was below the dose limit detection of 0,1 mSv. Therefore, an estimation of the transport dose was derived from this dose detection limit extrapolated to one working year. The values obtained are indicated in Table 11. It shows that the dose absorbed during transport represents less than 20% of the total dose absorbed by the radiographer. The major part of the dose is then due to the use of these sources and not to the transport. Nevertheless, this evaluation should be consolidated by more measurements on a longer period of time.

## 2.3 Public exposure

The objective was to evaluate the doses on the public associated with the transportation of radioactive materials in France. Assessments were performed for the different types of transported material (radiopharmaceutics, nuclear fuel cycle, civil industry and research). An evaluation of the collective dose is given and complementarily, individual doses have been estimated for some relevant transport types considering different hypothetical scenarios of exposure. This work was performed by CEPN and the study is given in annex 4.

### 2.3.1 Collective dose

Collective doses associated with the transport operations were calculated using the computer code developed by IAEA (INTERTRAN), on the basis of external exposure from the vehicle containing radioactive material, the content, the type of package, the mode of transport (road or rail), the distance travelled and the number of vehicle stops.

#### 2.3.1.1 Radiopharmaceutics

The transport of medical source in 1997 is estimated to be approximately 198 600 packages. The evaluation of the collective dose to the public associated with the transportation of radioactive sources for medical purpose was based on a previous study on road accident involving Type A package in France. The characteristics of the transport are given in the following table. Calculations of collective dose associated with the transport of these packages were performed with INTERTRAN2 and the results are presented in table 12. The total collective dose associated with the transport of radioactive sources for medical purpose in France in 1997 is estimated from 1 300 to less than 3 168 man.mSv assuming that the dose rate at 1 meter of the vehicle doesn't exceed 0.2 mSv/h. [4], [5], [6] and [7] are used for this evaluation.

Table 12. Characteristics of the transport of medical sources in France – year 1997

Destination	Nb transports	Nb packages	Range of TI (vehicle)	Aver. Nb of packages /transport
Airport	938	36 609	5-40	39
Paris	469	9 829	2-20	21
France (Paris excepted)	1 876	44 004	10-40	23
Europe	469	46 528	15-50	99
<b>Total</b>	<b>3 751</b>	<b>136 970</b>		

Destination	Fraction in zone (%)			Unit collective dose (man.Sv per km.TI)
	Rural	Sub-urban	Urban	
Airport	0	80	20	3,27E-07
Paris	0	20	80	1,14E-06
France (Paris excepted)	70	20	10	1,55E-07
Europe	90	7	3	4,91E-08

### 2.3.1.2 Nuclear fuel cycle

Collective dose associated with transports described in paragraph 1.1.2 leads to a total collective dose of 388 man.mSv and were calculated with ExternE [1]. [1], [2] and [7] are used for this evaluation.



Table 13. Collective doses to the public associated with transportation stages in nuclear fuel cycle

Material transported	Collective dose (man.mSv) France, year 1997
Concentred ore	3,42E-03
UF <sub>4</sub>	2,03E-01
UF <sub>6</sub> natural	1,25E-02
UF <sub>6</sub> enriched	8,79E-02
UO <sub>2</sub> fuel assembly	1,60E+02
Spent fuel	1,06E+01
UO <sub>2</sub> (NO <sub>3</sub> ) <sub>2</sub>	3,37E+00
Radioactive wastes	2,14E+02
<b>Total</b>	<b>3,88E+02</b>

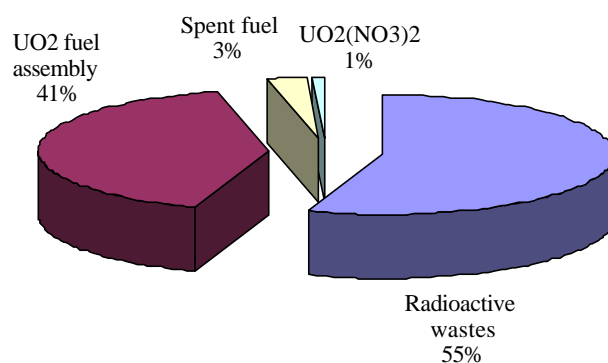

Figure 7. Distribution of total collective doses associated with the transports of nuclear fuel cycle

2.3.1.3 Civil industry and research

Intertran II was used to assess the collective dose for the public associated with these transports [4]. The total collective dose is estimated to be between 830 and 1630 man.mSv.

Table 14. Transport flows associated with civil industry

Package type	Total transports of package type	Dose rate at 1m of shipment (mSv/h)
A	70 000	0.002 <sup>†</sup>
B	50 000	0.004 – 0.01 <sup>‡</sup>
E	260 000	0

<sup>†</sup> Value for gamma density gauges

<sup>‡</sup> Value for gammagraphs

Table 15. Transport flows associated with civil nuclear research

Package type	Total transports of package type	Dose rate at 1m of shipment (mSv/h)
A	1630	0.2 <sup>†</sup>
B	433	0.2 <sup>†</sup>
E	4223	0
IP	242	0.2 <sup>†</sup>
Unspecified	581	0.2 <sup>†</sup>
Miscellaneous	98	0.2 <sup>†</sup>

<sup>†</sup> Derived from regulatory limit dose rate at 2m (0.1 mSv/h)

#### 2.3.1.4 Synthesis

Collective dose related to the transport of medical sources represent the highest contribution for the total public exposure. Public exposure associated with the transport of the nuclear fuel cycle are far below. The estimated total collective dose for all the transports of radioactive materials in France is between 2 and 5 man.Sv per year.

Table 16 : Summary of total collective doses for public – *Transport of radioactive materials, France, 1997*

Related industry	Total collective dose in man.mSv
Nuclear fuel cycle	388
Medical purposes	1300-3168
Civil industry	640-1450
Civil nuclear research	189
<b>Total</b>	<b>2515-5195</b>

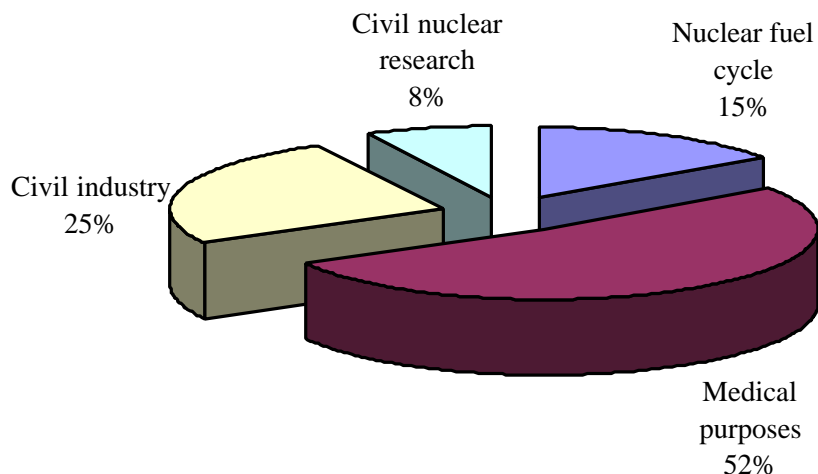

Figure 8. Distribution of total collective dose for the public associated with the transports of radioactive materials (France, 1997)

### 2.3.2 Individual exposures associated with hypothetical scenarios

Individual doses for public have been evaluated in previous studies for some types of transport. For the others a calculation has been performed.

#### 2.3.2.1 Radiopharmaceutics

##### Christ de Saclay

##### Scenario 11

All shipments of medical sources from SCHERING CIS BIO pass through a small village, named “Christ de Saclay”, before reaching the closest main road (National road n°118) through a major crossroad. A hotel-restaurant is located in the vicinity of this crossroad. The dose of an hypothetical individual working in this hotel-restaurant and being exposed to all transports of the medical sources was calculated with INTERTRAN 2, assuming the vehicles transporting the sources are passing through this zone at a 10 km/h speed, at a distance of 30 m. A shielding factor of 0.1 was considered to take into account the attenuation of dose rates through building walls. This factor does not account for wall openings (doors, windows) therefore this factor brings an underestimation effect but it is estimated that it more or less compensates the overestimation effect represented by the fact that one person is not exposed to all the transports in the selected conservative conditions.

The dose rate at 1m from vehicles carrying medical sources was supposed to be 0.2 mSv/h (derived from the regulatory limit dose rate at 2m from shipment of 0.1 mSv/h). A total flux of 4 160 vehicles per year was considered. Additionally, the doses associated with 200 transports of Type-B (gammagraphs) in the same area were calculated, for a dose rate at 1m from vehicle of 0.01 mSv/h (upper value).

Table 17. Doses associated with “Christ de Saclay” scenario – Type-A and Type-B sources

Type of transport	Dose rate at 1m of shipment (mSv/h)	Nb transports	Dose
Medical (SCHERING CIS-BIO)	0.2	4 160 vehicles/y	0.84 $\mu$ Sv
Type-B	0.01	200 vehicles/y	$2 \times 10^{-3}$ $\mu$ Sv

The total dose associated with the transport of medical sources (SCHERING CIS-BIO) is estimated to be about 0.84  $\mu$ Sv for a flux of 4 160 vehicles/y, while the one of 200/y Type-B transports are estimated to  $2 \times 10^{-3}$   $\mu$ Sv.

## In transit storage at TransRoute Santé

### Scenario 12

Medical sources shipped by SCHERING CIS-BIO to be delivered in French provinces converge in a locality in the South of Paris which serves as a transit platform for shipments. Over one week, about 200 packages may be stored in this platform for an average duration of 2 hours/day on Monday, Wednesday and Thursday, while about 300 others may be stored for an average duration of 5 hours/day on Tuesday and Friday. About 60% of these packages are of Type-A while remaining 40% are excepted packages. For simplification purposes, it was assumed for calculations that 50% of Type-A packages have a TI of 0.2 and 50% have a TI of 2 (maximum value).

Assuming that an hypothetical individual may be standing close to the stored packages at a minimum distance of 50 m for the whole storage duration, the dose resulting from the ambient dose rates was calculated. The 200-300 stored packages were treated as a stock-pile of a spherical volume of 1 m characteristic radius (given the 30 cm x 30 cm x 30 cm dimensions of such packages). Resulting dose rate at a distance of 50 m was calculated by assuming the stock-pile as a point source, according to the formulae given in Appendix 1 of Annex 4. An additional shielding factor of 0.1 was considered to take into account the attenuation of building walls. The contribution of excepted packages (Type-E) was not taken into account.

Table 18. Doses associated with “storage at TransRoute Santé” scenario – medical Type-A packages

Type of exposure	Duration of exposure	Dose rate at 50 m <sup>†</sup>	Dose <sup>‡</sup>
200 packages stock-pile	2 hour per day, 3 days per week, 47 weeks per year	2 $\mu$ Sv/h	60 $\mu$ Sv
300 packages stock-pile	5 hours per day, 2 days per week, 47 weeks per year	3 $\mu$ Sv/h	140 $\mu$ Sv
<b>Total</b>			<b>200 mSv</b>

<sup>†</sup> Assuming 60% of packages of Type-A with TI of 0.2 (50% Type-A) and 2 (50% Type-A)

<sup>‡</sup> Assuming a shielding factor of 0.1 for people inside buildings

The total dose associated with the exposure to temporary stored packages at TransRoute Santé is in the order of magnitude of 200  $\mu$ Sv if the exposed individual stays 100% of storage time at the distance of 50m from packages. Considering that the exposure time could be only 60% of total storage time, the dose would be about 120  $\mu$ Sv.

#### 2.3.2.2 Nuclear fuel cycle

### Exposure along railways

#### Spent fuel – Scenario 1

A study [1] performed by IRSN in 1999 presents calculations of doses for the public associated with the transportation of spent fuel casks by rail from nuclear power plants to the Valognes rail terminal, before these casks are transported (by road) from Valognes to the reprocessing plant located in La Hague. All casks coming from French nuclear plants converge in Sotteville terminal before being transported from Sotteville to Valognes. This last rail section can consequently be considered as the most penalising one in terms of individual exposure of the population living along the railway, because all spent fuel casks will be transported on this itinerary.

Considering a flux of 200 spent fuel casks transported yearly from French and foreign power plants to La Hague (data from IRSN database), the dose received by an hypothetical individual standing along the railway at a distance of 30 m, between Sotteville and Valognes terminals, was estimated to be less than 1.1 µSv/year.

## Vitrified wastes – Scenario 2

Based on the results from the study [11] performed by IRSN for spent fuel casks between Valognes and Sotteville rail terminal, the exposures of an hypothetical individual standing along the railway in the vicinity of Valognes terminal after departure of trains conveying vitrified waste casks at a distance of 30 m were evaluated.

Transport index of vitrified wastes shipments are in the range of 10-15. One cask (TN28) is transported in each train convoy. A total of 10 vitrified waste shipments is transported yearly from Valognes (data from IRSN database).

The corresponding dose is estimated to be in the range from 0.05 µSv/year (for TI = 10) to 0.08 µSv/year (for TI = 15).

## UO<sub>2</sub>(NO<sub>3</sub>)<sub>2</sub> LR 65 containers – Scenario 3

The exposure of an hypothetical individual standing along the railway in the vicinity of Valognes terminal after departure of trains conveying LR 65 containers (uranyl nitride in solution from reprocessing) at a distance of 30 m from railways was evaluated.

A single LR 65 container is transported on each wagon. The transport index of the wagon is taken to be 3. A total number of 239 containers is supposed to be transported a year.

Based on the results from the study [11] performed by IRSN for spent fuel casks between Valognes and Sotteville rail terminal, the dose associated with the transport of LR 65 containers is estimated to be about 0.4 µSv.

## Exposures during train stops

### Sotteville terminal – Scenario 4

Convoys of spent fuel may stay in the rail terminal of Sotteville for 10-12 hours in average. The dose received by an hypothetical individual standing in buildings of the terminal at distances of 40 and 100 m respectively was estimated, considering a transfer of 200 spent fuel casks. A shielding factor of 0.1 was also considered, stating that the hypothetical individual would stay inside buildings. Dose rate (DR) at given distances (d) from shipment was calculated by the following formulae, assuming the shipment of characteristic dimension (λ) can be considered as a point source for such high values of d.

$$DR(d) = DR(1\text{ m}) \cdot \frac{\left(1 + \frac{\lambda}{2}\right)^2}{\left(d + \frac{\lambda}{2}\right)^2}$$

with λ and d in meters.

DR(1m) = 100 µSv/h corresponds to the dose rate at a distance of 1m from shipment. The characteristic dimension of spent fuel casks is taken to be 6 m.

Table 19. Doses associated with “train stops in Sotteville terminal” scenario – Spent fuel

Distance from shipment	Time stop for each shipment	Dose for 1 shipment †	Total annual dose † (200 shipments)
40 m	10 h	0.86 µSv	170 µSv
	12 h	1.03 µSv	200 µSv
100 m	10 h	0.15 µSv	30 µSv
	12 h	0.18 µSv	36 µSv

<sup>†</sup> Assuming a shielding factor of 0.1 for people inside buildings

Doses associated with such a scenario are in the order of magnitude of 0.1-1  $\mu\text{Sv}$  for one shipment of spent fuel, corresponding to extreme values ranging from 30 to 200  $\mu\text{Sv}/\text{year}$  if considering 200 shipments per year.

### Sotteville terminal – Scenario 5

The Sotteville terminal is crossed by several concrete bridges where people can stay. Assuming that a hypothetical individual may stand for 30 minutes in his car on a bridge under which the loaded wagon is stopped, the corresponding dose was calculated on the basis of a minimum distance of 2 m from the shipment and a dose rate equal to the dose rate at 1 m of the surface of shipment (eg. 100  $\mu\text{Sv}/\text{h}$ ), given the shortness of the considered distance as compared with the characteristic dimension of the cask (6 m). A shielding factor of 0.1 was also considered for the protection of bridge concrete and car.

From this, the dose resulting from the exposure to a single shipment of spent fuel was estimated to be:  $D = 0.1 \times 0.5 \times 100 = 5 \mu\text{Sv}$ .

### Exposure during road stops

#### Spent fuel – Scenario 6

During the road transportation between Valognes terminal and La Hague reprocessing plant, it is supposed that the convoys (trucks) may be stopped for an average of 2 minutes at a light. Considering an hypothetical individual standing in a building at a reference distance of 10 m from the shipment, the corresponding dose was calculated for the annual number of spent fuel shipments.

The dose rate was estimated on the same basis as previously described (see appendix 1 of annex 4). Results are presented in Table 20.

Table 20. Doses associated with “truck stops at road light” scenario – Spent fuel

Distance from shipment	Time stop for each shipment	Dose for 1 shipment <sup>†</sup>	Total annual dose <sup>†</sup> (200 shipments)
10 m	2 minutes	0.03 $\mu\text{Sv}$	6 $\mu\text{Sv}$

<sup>†</sup> Assuming a shielding factor of 0.1 for people inside buildings

Doses associated with such a scenario are in the order of magnitude of 0.03  $\mu\text{Sv}$  for one shipment, corresponding to a value of about 6  $\mu\text{Sv}/\text{year}$  if considering 200 shipments per year. These values, obtained for a reference distance of 10m from shipments, might be multiplied by a factor 4 if this distance was reduced from 10m to 3m.

#### Vitrified wastes – Scenario 7

During the road transportation between La Hague reprocessing plant and Valognes terminal, it is supposed that the convoys (trucks) may be stopped for an average of 2 minutes at a traffic lights. Considering an hypothetical individual standing in a building at a reference distance of 10 m from the shipment, the corresponding dose was calculated for the annual number of vitrified wastes shipments.

The dose rate was estimated on the same basis as previously described. Results are presented in Table 21. Transport index of vitrified wastes shipments is supposed to range from 10 to 15.

Table 21. Doses associated with “truck stops at road light” scenario – Vitrified wastes

Distance from shipment	Time stop for each shipment	Dose for 1 shipment <sup>†</sup>	Total annual dose <sup>†</sup> (10 shipments)
10 m	2 minutes	0.03-0.05 $\mu\text{Sv}$	0.3-0.5 $\mu\text{Sv}$

<sup>†</sup> Assuming a shielding factor of 0.1 for people inside buildings

Doses associated with such a scenario are in the order of magnitude of 0.03-0.05  $\mu\text{Sv}$  for one shipment, corresponding to values ranging from 0.3 to 0.5  $\mu\text{Sv}/\text{year}$  if considering 10 shipments per year. These values, obtained for a reference distance of 10m from shipments, might be multiplied by a factor 5 if this distance was reduced from 10 m to 3 m.

### UO<sub>2</sub>(NO<sub>3</sub>)<sub>2</sub> LR 65 containers – Scenario 8

During the road transportation between La Hague reprocessing plant and Valognes terminal, it is supposed that the convoys (trucks) may be stopped for an average of 2 minutes at a light. Considering an hypothetical individual standing in a building at a reference distance of 10 m from the shipment, the corresponding dose was calculated for the annual number of LR 65 containers shipments, taken to be 239.

The dose rate was estimated on the same basis as previously described. Results are presented in Table 22. Transport index of LR 65 containers is supposed to be 3.

Table 22. Doses associated with “truck stops at road light” scenario – LR 65 containers

Distance from shipment	Time stop for each shipment	Dose for 1 shipment <sup>†</sup>	Total annual dose <sup>†</sup> (239 shipments)
10 m	2 minutes	$9.5 \times 10^{-3} \mu\text{Sv}$	2.3 $\mu\text{Sv}$

<sup>†</sup> Assuming a shielding factor of 0.1 for people inside buildings

Doses associated with such a scenario are in the order of magnitude of 0.01  $\mu\text{Sv}$  for one shipment, corresponding to about 2.3  $\mu\text{Sv}/\text{year}$  if considering 239 shipments per year. These values, obtained for a reference distance of 10 m from shipments, might be multiplied by a factor 5 if this distance was reduced from 10 m to 3 m.

### Unirradiated fuel assemblies – Scenario 9

During the road transportation from FBFC Romans to reactors, it is supposed that the convoys of fuel assemblies (trucks) may be stopped for an average of 2 minutes at a light in localities in the vicinity of FBFC. Considering an hypothetical individual standing in a building at a reference distance of 10 m from the shipment, the corresponding dose was calculated for the 196 annual fuel assemblies shipments taken from [6].

The dose rate was estimated on the same basis as previously described (see appendix 1 of annex 4). Results are presented in Table. Transport index of fuel assemblies shipment (4 RCC) is taken to be 6.5 [6].

Table 23. Doses associated with “truck stops at road light” scenario – fuel assemblies

Distance from shipment	Time stop for each shipment	Dose for 1 shipment <sup>†</sup>	Total annual dose <sup>†</sup> (196 shipments)
10 m	2 minutes	0.02 $\mu\text{Sv}$	4 $\mu\text{Sv}$

<sup>†</sup> Assuming a shielding factor of 0.1 for people inside buildings

Doses associated with such a scenario are in the order of magnitude of 0.02  $\mu\text{Sv}$  for one shipment, corresponding to 4  $\mu\text{Sv}/\text{year}$  if considering 196 shipments per year. These values, obtained for a reference distance of 10m from shipments, might be multiplied by a factor 5 if this distance was reduced from 10m to 3m.

### Enriched UF<sub>6</sub> – Scenario 10

During the road transportation of UF<sub>6</sub> (enriched) to FBFC Romans, it is supposed that the shipments (trucks) may be stopped for an average of 2 minutes at a light in villages in the vicinity of FBFC. Considering an hypothetical individual standing in a building at a reference distance of 10 m from the shipment, the corresponding dose was calculated for the 95 UF<sub>6</sub> shipments taken from [6].

The dose rate was estimated on the same basis as previously described (see appendix 1 of annex 4). Results are presented in table 24. Transport index of enriched UF6 (6 x COG OP 30 B) is taken to be 1 (between 0.6 and 0.8 according to [6]) for full packages and 10 for empty packages [6].

Table 24. Doses associated with “truck stops at road light” scenario – UF6

Distance from shipment	Time stop for each shipment	Dose for 1 shipment (full package) <sup>†</sup>	Total annual dose <sup>†</sup>
10 m	2 minutes	$3 \times 10^{-3} \mu\text{Sv}$	2 $\mu\text{Sv}$

<sup>†</sup> Assuming a shielding factor of 0.1 for people inside buildings

Doses associated with such a scenario are in the order of magnitude of  $3 \times 10^{-3} \mu\text{Sv}$  for one shipment with full packages and  $0.03 \mu\text{Sv}$  for one shipments with empty packages. If considering 95 shipments per year with full packages and around 70 shipments with empty packages the total doses is 2  $\mu\text{Sv}$ . These values, obtained for a reference distance of 10 m from shipments, might be multiplied by a factor 5 if this distance was reduced from 10 m to 3 m.

#### 2.3.2.3 Radioactive wastes (nuclear fuel cycle and civil research and industry)

### Exposure during road stops

#### Scenario 13

During the road transportation of radioactive wastes to the storage centre located in the department of Aube (CSA), it is supposed that the convoys (trucks) may be stopped for an average of 2 minutes at a light in one of the small villages in the vicinity of the CSA. Considering an hypothetical person standing in a building at a reference distance of 10 m from the shipment, the corresponding dose was calculated for an annual number of wastes shipments estimated to 1 355 vehicles per year (number of vehicles arrived at the CSA in the year 2000 according to IRSN database).

All radioactive wastes are supposed to be transported into containers ISO 20'. Two containers are transported on each shipment. The dose rate at 1m from shipment was taken to 0.2 mSv/h, value derived from the regulatory limit dose rate at 2m (0.1 mSv/h).

The dose rate was estimated on the same basis as previously described and detailed in appendix 1 of annex 4. Results are presented in Table 25.

Table 25. Doses associated with “truck stops at road light” scenario – Wastes

Distance from shipment	Time stop for each shipment	Dose for 1 shipment <sup>†</sup>	Total annual dose <sup>†</sup> (1 355 shipments)
10 m	2 minutes	0.01-0.05 $\mu\text{Sv}$	13.5-67 $\mu\text{Sv}$

<sup>†</sup> Assuming a shielding factor of 0.1 for people inside buildings

Doses associated with such a scenario are in the order of magnitude of 0.01-0.05  $\mu\text{Sv}$  for one shipment, corresponding to values ranging from 13 to 70  $\mu\text{Sv}/\text{year}$  if considering 1 355 shipments per year. These values, obtained for a reference distance of 10m from shipments, might be multiplied by a factor 8 if this distance was reduced from 10m to 3m.

#### 2.3.2.4 Synthesis of individual doses estimated for public

Table 26 summarises the individual doses estimated for the public, associated with the transport of radioactive materials in France for different hypothetical exposure scenarios. These scenarios refer to hypothetical individuals who may be exposed in normal conditions of transport. The assumptions made can be conservative in some cases, but this should be confirmed by an in-deeper study on more realistic critical groups.

Most penalising scenarios are associated with Type-A medical sources (Scenario 12), spent fuel (Scenario 4) and radioactive wastes from nuclear fuel cycle and civil research and industry (Scenario 13), leading to estimated individual exposures of a hundred of  $\mu\text{Sv}$ .



**Table 26 Summary of individual doses for public – Hypothetical scenarios of exposure associated with the transport of radioactive materials in France**

Related industry	Scenario	Individual dose
Nuclear fuel cycle	Scenario 1: spent fuel; exposure along railways	1.1 $\mu\text{Sv/y}$ (200 shipments)
	Scenario 2: vitrified wastes; exposure along railways	0.05-0.08 $\mu\text{Sv/y}$ (10 shipments)
	Scenario 3: Uranium oxide LR 65 containers; exposure along railways	0.4 $\mu\text{Sv/y}$ (239 shipments)
	Scenario 4: spent fuel; train stops near buildings	30-200 $\mu\text{Sv/y}$ (200 shipments)
	Scenario 5: spent fuel; train stops under bridge	5 $\mu\text{Sv}$ (single shipment)
	Scenario 6: spent fuel; truck stops at road light	6 $\mu\text{Sv/y}$ (200 shipments)
	Scenario 7: vitrified wastes; truck stops at road light	0.3-0.5 $\mu\text{Sv/y}$ (10 shipments)
	Scenario 8: Uranium oxide LR 65 containers; truck stops at road light	2.3 $\mu\text{Sv/y}$ (239 shipments)
	Scenario 9: fuel assemblies, truck stops at road light	4 $\mu\text{Sv/y}$ (196 shipments)
	Scenario 10: UF <sub>6</sub> , truck stops at road light	2 $\mu\text{Sv/y}$ (95 shipments with empty packages and 70 shipments with full packages)
Medical sources	Scenario 11: SCHERING CIS-BIO transports through “Christ de Saclay”	0.84 $\mu\text{Sv/y}$ (4 160 Type-A vehicles) 0.002 $\mu\text{Sv/y}$ (200 Type-B vehicles)
	Scenario 12: Storage at TransRoute Santé	120 $\mu\text{Sv/y}$ (SCHERING CIS-BIO Type-A packages)
Radioactive wastes (nuclear fuel cycle and civil research and industry)	Scenario 13: truck stops at road light	13-67 $\mu\text{Sv/y}$ (1 355 shipments delivered to CSA)

### 2.3.3 Conclusion

This study presents results on estimates of collective doses to the public associated with the transport of radioactive materials in France for the year 1997. It has been performed on the basis of previous studies and complementary data provided by IRSN for year 2002.

Collective doses related to the transport of medical sources represent the highest contribution (52%) to the total public exposure, ranging from 1 300 to 3 200 man.mSv over a total comprised between of 2 and 5 man.Sv. Public exposures associated with the transport of radioactive material from the nuclear fuel cycle are far lower, i.e. a few hundreds of man.mSv/year. These results can be put into perspective with the total collective dose associated with the whole nuclear fuel cycle in France calculated in [1], which estimated to about 5 thousands man.Sv the collective dose for the public, for an annual nuclear electricity generation of 376 TWh.

The maximum individual doses associated with hypothetical routine scenarios for the different types of transports considered are estimated to be about 120-200  $\mu$ Sv/y. They correspond to the flows of spent fuel, radioactive wastes converging to the storage centre of Aube (CSA) and to the temporary storage of medical sources from SCHERING CIS-BIO at TransRoute Santé.

These figures were derived for transport situations free from any accident or incident. In case of accident, the regulatory prescriptions aim at limiting individual doses to less than 50 mSv.

### 3. CONCLUSION

In 1997, French carriers and consignors have declared 345 000 packages transported through 31 000 transports. The number of transports of gammagraphs, gamma density gauges and lead analysers were underestimated and the total number of packages transported could be 700 000 according to last our estimation. The work performed has highlighted that a significant number of users of packages for civil industries had been forgotten; in addition due to a new regulation concerning the trade of ancient lodgings (ministerial order dated 12<sup>th</sup> of july 1999 requiring mandatory check of presence of lead in wall paintings) a new category of transport now exists which corresponds to an annual flux of 260 000 transports approximately.

The maximum occupational doses due to transport for the workers are 37.5 mSv/year for the transport of radiopharmaceutics, 4 mSv/year for the transport of nuclear fuel cycle material and 0.7 mSv/year for the transport for the civil industry and research. The study indicates that for year 2002 the maximum dose for the transport of radiopharmaceutics is 17 mSv/year.

The associated annual collective dose for the public is comprised between 2 and 5 man.Sv and the maximum public exposure associated to estimated conservative scenario is 200  $\mu$ Sv/year.

All the doses are less than or in a few cases of the same magnitude as the actual limits of doses recommended by the European directive 96/29 which sets a limit on effective dose for workers of 20 mSv/y averaged over five consecutive years. For the public the limit on effective dose is 1 mSv/year.

Further improvements in the radiopharmaceutics transport aiming at reducing the occupational dose are recommended; they would involve a study of the drivers working conditions and an assessment of their protections.

To improve the knowledge of the doses received by the public, a systematic study would be necessary, and particularly dealing with the areas near the nuclear sites or along the ways frequently used by the conveyances. Such studies are expected to be included in the RPP of the operators.

## 4. REFERENCES

- [<sup>1</sup>] DREICER M., TORT V., MARGERIE H., The external costs of the nuclear fuel cycle: Implementation in France, CEPN Report No.238, 1995.
- [<sup>2</sup>] DREICER M., TORT V., MANEN P., Nuclear fuel cycle: estimation of physical impacts and monetary valuation for priority pathways, CEPN Report No.234, 1995.
- [3] TORT V., RANCILLAC F., SCHNEIDER T., Analyse du transport des déchets de faible et moyenne activités vers le centre de stockage de l'Aube, Rapport CEPN No.206, 1992.
- [4] TABARE M., RANCILLAC F., Bilan des flux de transport de matières radioactives portées à la connaissance de l'IRSN, année 1997, Rapport DSMR/2000-004 Rév.0, 2000.
- [<sup>5</sup>] RAFFESTIN D., SCHNEIDER T., Assessment of the radiological risks of road transport accidents involving type-A packages, 1997.
- [6] LIZOT M.T., Survey of operational data for transport – CRP contamination, IRSN/DSMR/SSTR draft report SSTR/02-376, 2002.
- [<sup>7</sup>] AMC Konsult AB, INTERTRAN 2, Transportation Risk Assessment Package.
- [8] HUBERT P., PAGES P, L'évaluation de la sûreté des transports de matières radioactives : cas d'un petit colis de type B, Rapport CEPN No.36, 1981.
- [9] HUBERT P., PAGES P, L'évaluation de la sûreté des transports de matières radioactives : le cas des petits colis de type A, Rapport CEPN No.42, 1982.
- [10] HUBERT P., PAGES P, Fixation d'une limite d'activité pour le transit des produits pharmaceutiques à travers le tunnel du Mont-Blanc : éléments d'appréciation, Rapport CEPN No.90, 1985.
- [<sup>11</sup>] JUANOLA M., Evaluation de la dosimétrie associée au transport de combustibles irradiés à l'aide d'INTERTRAN 2, Note Technique SEGR/SAER/99-106, 1999.
- [12] CELLIER D, N. BRISSON, CP. VIDAL, JL. PASQUIER, Compte rendu d'intervention n°2002/016-I du 21 janvier 2002.
- [<sup>13</sup>] BEN OUAGHREM K., Bilan 2001 des fiches de suivi d'emballages, SSTR/02-819, 2002.

# **ANNEX 1**

## **STATISTICS ON RADIOACTIVE MATERIAL TRANSPORT FLOW OF YEAR 1997 REPORTED TO IRSN**

Authors:

Mireille TABARE and Françoise RANCILLAC



**REPORT DSMR/2000-004 REv. 0**

**STATEMENT OF  
RADIOACTIVE MATERIAL  
TRANSPORT FLOWS  
REPORTED TO IPSN  
YEAR 1997**

**Mireille TABARE  
Françoise RANCILLAC**

**May 2000**

**STATEMENT OF RADIOACTIVE  
MATERIAL TRANSPORT FLOWS  
REPORTED TO IPSN  
YEAR 1997**

Authors: Mireille TABARE\* and Françoise RANCILLAC\*\*

\* MEGAO Informatique Technoparc des Hautes Faventines  
14 rue Jean Bertin  
26000 Valence  
Order No.1300222, 03/08/2000

\*\* IPSN/DSMR/SSTR

Financed by: IPSN - Order No. 4050 00000128, 03/09/2000

Date: May 2000

Reference: REPORT DSMR/2000-004 Rev. 0

## CONTENTS

	<b>Page</b>
<b>1. Introduction</b>	<b>4</b>
<b>2. Lessons to be acquired for a future collection of transport flows</b>	<b>4</b>
<b>3. Analysis of transported materials</b>	<b>5</b>
<b>4. Remarks concerning the definition of the "transport" word</b>	<b>8</b>
<b>5. Study of the transport mode</b>	<b>9</b>
<b>6. Analysis of the type of packages</b>	<b>10</b>
<b>7. Analysis of the material category</b>	<b>12</b>
<b>8. Usage type of the material</b>	<b>13</b>
<b>9. Conclusion</b>	<b>16</b>
<b>Appendix 1:</b> Copy of the mail requesting a declaration of transport flows	<b>17</b>
<b>Appendix 2:</b> A2.1. Exhaustive inventory of the various designations met in the "Material" column and correspondence with the nomenclature selected for calculations A2.2. List of categories selected for the "Material" column in alphabetical order	<b>22</b>
<b>Appendix 3:</b> Inventory of elements listed in the "Type of package" column and correspondence with the nomenclature selected for calculations	<b>28</b>
<b>Appendix 4:</b> List of radioactive material transport shippers radioactives ayant communiqué leurs flux de transport en 1997 having communicated their transport flows in 1997	<b>29</b>

## 1. Introduction

This survey covers the analysis of radioactive material transport flows with regard to French companies for the year 1997. This work would not have been possible without the cooperation of French companies from which IPSN requested the communication of their transport flows.

The IPSN purpose is to periodically conduct this type of survey in order to better understand the transports of radioactive materials. The purpose of this knowledge is:

- to understand the hazard generated by radioactive transports,
- in case of accident, to be able to inform the media about the transport flows associated to the transports concerned by the accident,
- to warn the Prefects about the transport flows transiting via their department so that they can better prepare to face potential accidents or match the local networks to the potential hazards,
- and finally, to better know the use of the various types of packaging.

To conduct this survey, it was first necessary to gather the information with regard to transport flows. For this purpose, a request for "Declaration of radioactive material transport flows for the year 1997" was sent to 56 French companies (see **Appendix 1**). These 56 companies represented all the companies known by IPSN and likely to transport radioactive materials. Since that time, other companies were listed, these 56 companies are in no way exhaustive, but cover the companies ensuring the more transports.

The request for declaration more specially concerned the number of transports performed and packages transported, the types of packaging, the transport modes, the radioactive materials contained in the packages, the material categories and the usage types of the transported material. This survey describes the statistical analysis of all the above-mentioned parameters.

Among the 56 companies contacted, 30 returned a flow declaration, thus representing a 53% replay ratio. Among the 26 companies that did not reply, some are sub-contractors of others; these missing replies thus do not affect the overall result. The companies for which the flow was not counted at all should not be among the most important with regard to transport quantity.

However, the results should be considered with care, due to the non-exhaustiveness of all transports and considering that certain transports may have been counted twice by two different companies. It is recommended to consider only the values that should be subsequently checked over the following years.

## 2. Lessons to be acquired for a future collection of transport flows

The request for transport flow declaration included an appended table covering the following items (see **Appendix 1**):

- Material
- Location of departure
- Location of arrival
- Transport mode
- Type of package
- Name of package
- Number of transports (number of transports performed between the place of departure and the place of arrival)
- Number of packages (total number of packages transported during the x above-mentioned transports)
- Weight (total weight transported during the x transports)
- Fissile weight (total fissile weight transported during the x transports)
- Total activity
- Material category
- Usage type of the material

This survey could not analyze the following parameters:

- Place of departure



- Place of arrival
- Name of package
- Weight
- Fissile weight
- Total activity

As these parameters were often incorrectly completed with, for instance a consistency problem for the units used.

For future collections, a simplification is recommended, as transports are too different to be described in the same format.

Furthermore, each company should be requested to globalize these flows instead of trying to detail them transport by transport, as this was requested.

### 3. Analysis of transported materials

As the replies provided in the material items are highly varied (see the various designations met in **Appendix 2**), they were gathered in accordance with the following list:

#### a - Radionuclide sources

Am  
 Am, Be  
 Am, Co, Cs  
 Am, Co, Pu, U  
 Am, Np, Pu  
 Am, Sr  
 Ar  
 Ar, Br  
 B  
 B, Cl  
 Ba  
 Ba, Co  
 Ba, Co, Cs  
 Ba, Fe  
 Be  
 Be, Ra  
 Bi, Co, Na, Ni  
 Cd, Eu  
 Cd, Pu, Sr  
 Ce, Co, Pu, U  
 Cf  
 Cf, Co  
 Cf, Eu, Ho  
 Cl  
 Cm  
 Co  
 Co 60 sealed  
 Co, Cr, Fe  
 Co, Cs  
 Co, Cs, Eu  
 Co, Cs, Ra, Sr  
 Co, Ir  
 Cr  
 Cs  
 Cs 137 sealed  
 Cs, Np, Pu  
 Cs, T  
 Cu

Cu, Fe, Ni, Np  
 Eu  
 Fe  
 Gd  
 Ge  
 Hf  
 Hg  
 Ho  
 I  
 Ir  
 Kr  
 Kr, Xe  
 Md  
 Mn  
 Mo  
 Na  
 Ni  
 Np  
 P  
 Ra  
 Ru  
 Sn  
 Sr  
 Sr, Y  
 T  
 T, I  
 Tc  
 Ti  
 Xe  
 Y  
 Yb

Gammagraph  
 $\alpha$ ,  $\beta$ ,  $\gamma$  sources

## **b - Uranium-based materials**

U concentrate  
 U; Udepl; Unat; Udepl, Unat; Uenr; Umet; Unat, Np; UF<sub>4</sub>; UF<sub>6</sub> nat and enr  
 UO<sub>2</sub> ; UO<sub>2</sub>depl; UO<sub>2</sub>enr; UO<sub>2</sub> powder; UO<sub>2</sub>/U<sub>3</sub>O<sub>8</sub>  
 Fuel, fresh  
 Fuel, irra  
 Fuel, research  
 UNH  
 Uranates  
 URT  
 URE  
 Th

## **c - Pu-based materials**

PuO<sub>2</sub>  
 MOX  
 Pu  
 Pu, U  
 Pu, Umet  
 UO<sub>2</sub>, PuO<sub>2</sub>

## **d - Wastes**

Wastes; Alpha wastes; FA wastes; FMA wastes; Gaseous wastes; Liquid wastes; Solid wastes; Wastes (URT) ; act or cont stru  
Vitrified residues

**e – Others**

Miscellaneous

Empty

Unknown

Table 1 specifies the number of transports and transported packages depending on the material.

**Table 1. Number of transports and transported packages per type of material**

**in alphabetical order**

Matière	Nombre de transports	Nombre de colis	% Nombre de transports	% Nombre de colis	Matière	Nombre de transports	Nombre de colis	% Nombre de transports	% Nombre de colis
Am	36	46	0,38	0,013	Hg	4	13	0,04	0,004
Am, Be	9	9	0,09	0,003	Ho	2	2	0,02	0,001
Am, Co, Cs	15	49	0,16	0,014	I	219	769	2,31	0,223
Am, Co, Pu, U	1	1	0,01	0,000	inc	107	210687	1,13	60,989
Am, Np, Pu	1	11	0,01	0,003	Ir	267	287	2,81	0,083
Am, Sr	2	3	0,02	0,001	Kr	10	10	0,11	0,003
Ar	11	17	0,12	0,005	Kr, Xe	1	1	0,01	0,000
Ar, Br	2	4	0,02	0,001	Md	3	3	0,03	0,001
B	1	1	0,01	0,000	Mn	5	5	0,05	0,001
B, Cl	2	144	0,02	0,042	Mo	59	59	0,62	0,017
Ba	21	21	0,22	0,006	MOX	46	200	0,48	0,058
Ba, Co	4	6	0,04	0,002	Na	5	5	0,05	0,001
Ba, Co, Cs	10	28	0,11	0,008	Ni	4	25	0,04	0,007
Ba, Fe	1	2	0,01	0,001	Np	7	25	0,07	0,007
Be	1	1	0,01	0,000	P	1	1	0,01	0,000
Be, Ra	1	1	0,01	0,000	Pu	147	1835	1,55	0,531
Bi, Co, Na, Ni	1	1	0,01	0,000	Pu, U	13	106	0,14	0,031
Cd, Eu	1	2	0,01	0,001	Pu, Umét	9	180	0,09	0,052
Cd, Pu, Sr	1	3	0,01	0,001	PuO2	76	752	0,80	0,218
Ce, Co, Pu, U	1	5	0,01	0,001	Ra	9	11	0,09	0,003
Cf	10	11	0,11	0,003	Résidus vitrifiés	2	4	0,02	0,001
Cf, Co	2	4	0,02	0,001	Ru	1	1	0,01	0,000
Cf, Eu, Ho	2	2	0,02	0,001	Sn	2	3	0,02	0,001
Cl	6	6	0,06	0,002	Sources a, b, g	15	59	0,16	0,017
Cm	3	6	0,03	0,002	Sr	23	23	0,24	0,007
Co	1135	4199	11,96	1,216	Sr, Y	2	4	0,02	0,001
Co 60 scellée	1	1	0,01	0,000	Stru act ou cont	393	2576	4,14	0,746
Co, Cr, Fe	1	1	0,01	0,000	T	71	458	0,75	0,133
Co, Cs	22	263	0,23	0,076	T, I	1	80	0,01	0,023
Co, Cs, Eu	4	4	0,04	0,001	Tc	27	27	0,28	0,008
Co, Cs, Ra, Sr	1	4	0,01	0,001	Th	44	507	0,46	0,147
Co, Ir	4	14	0,04	0,004	Ti	248	826	2,61	0,239
Comb irr	463	466	4,88	0,135	U	170	14049	1,79	4,067
Comb neuf	184	946	1,94	0,274	Uapp	348	3917	3,67	1,134
Comb recher	37	144	0,39	0,042	Uapp, Unat	3	8	0,03	0,002
Concentré U	208	49529	2,19	14,338	Uenr	334	2591	3,52	0,750
Cr	4	4	0,04	0,001	UF4	1515	1528	15,97	0,442
Cs	196	203	2,07	0,059	Umét	166	624	1,75	0,181
Cs 137 scellée	2	3	0,02	0,001	Unat	329	3737	3,47	1,082
Cs, Np, Pu	1	4	0,01	0,001	Unat, Np	1	1	0,01	0,000
Cs, T	1	2	0,01	0,001	UF6 enr	71	812	0,75	0,235
Cu	3	21	0,03	0,006	UF6 nat	67	1009	0,71	0,292
Cu, Fe, Ni, Np	1	3	0,01	0,001	UNH	314	663	3,31	0,192
Déchets	170	20475	1,79	5,927	UO2	53	1882	0,56	0,545
Déchets alpha	5	15	0,05	0,004	UO2/U3O8	1	4	0,01	0,001
Déchets FA	322	1119	3,39	0,324	UO2 app	1	46	0,01	0,013
Déchets FMA	219	9091	2,31	2,632	UO2 enr	29	357	0,31	0,103
Déchets gazeux	1	1	0,01	0,000	UO2 poudre	2	5	0,02	0,001
Déchets liquides	170	190	1,79	0,055	Uranates	1	48	0,01	0,014
Déchets solides	71	1280	0,75	0,371	URE	4	14	0,04	0,004
Déchets (URT)	2	288	0,02	0,083	URT	1	10	0,01	0,003
Divers	500	3977	5,27	1,151	Vide	250	1818	2,63	0,526
Eu	6	6	0,06	0,002	Xe	107	125	1,13	0,036
Fe	6	6	0,06	0,002	Y	4	4	0,04	0,001
Gammagraphe	2	2	0,02	0,001	Yb	1	1	0,01	0,000
Gd	1	1	0,01	0,000					
Ge	3	3	0,03	0,001					
Hf	2	2	0,02	0,001	Total	9488	345448	100,00	

Unkn stands for unspecified, it should be noted that for 61% of packages, the type of material contained is not specified.

Most packages concern U concentrates (14% of total), then wastes (6%), uranium (4%), FMA wastes (2.6%), depleted uranium (1%) and natural uranium (1%).

Most transports concern UF4 (5% of total), then Co (3.7% of total).

However, with regard to cobalt, it should be noted that some wastes or contaminated materials were listed in the cobalt item, as this concern the prevailing isotope, but not pure cobalt.

The "gammagraph" item was underrun (several tenths of thousands of transports, by several hundredths of scattered companies might be considered).

Table 2 gathers the materials into six items, to obtain a summary view of the whole.

**Table 2. Number of transports and transported packages per type of material globalized as: sources, uranium-based materials, plutonium-based materials, wastes, empty packages, and miscellaneous and unspecified**

Material	Number of transport	Number of casks	% Number of transport	% Number of casks
Radioactive sources	2683	8464	8,7	2,5
Material with Uranium	4302	82 388	13,9	23,8
Material with Plutonium	291	3 073	0,9	0,9
Waste	1373	32 463	4,4	9,4
Empty casks	250	1 818	0,8	0,5
Other + unspecified	22 150	217 242	71,3	62,9
<b>Total</b>	<b>31 049</b>	<b>345 448</b>	<b>100</b>	<b>100</b>

#### 4. Remarks concerning the definition of the "transport" word

This survey highlights the ambiguity existing in the definition of the "transport" word. This word in fact covers several meanings. A transport may mean moving a package from the sender to the recipient. But if the package changes transport mode on its way, by flying a plane for instance, three transports may exist for the same shipping, or even much more for small packages.

With regard to large packages, a transport is sometimes counted for a train with 3 wagons of irradiated fuels, and this also applies for UF6. Should the wagon or the train be considered as the transport unit?

A gammagraph transport for instance, may represent a round trip.

EDF did not filled in the item corresponding to the number of transports, we assessed it from the number of packages. One transport was assumed for 60 drums regardless of the mode, one road transport for 8 C1 or C4 concrete shells, one rail transport for 15 C1 or C4 shells.

Also, for SCHERING CISBIO International, it was assumed that each type B package generated a transport. The number of transports with regard to type A and excepted packages was assumed as 10 times lower than the number of packages.

The safest method is to count the number of transported packages and also knowing the maximum number of packages that may be loaded per transport unit, wagon or truck.

#### 5. Study of the transport mode

The various replies were classified in accordance with the following list:

R: road

F: rail  
M: sea  
A: air  
AR: air+road  
FM :FM: rail+sea  
FR: rail+road  
MR: sea+road  
Unkn: unspecified

Table 3 specifies the number of transports and transported packages depending on the transport mode.

**Table 3. Number of transports and transported packages per transport mode**

Transport mode	Number of transport	Number of Package	% Number of transport	% Number of package
Road	20897	195911	67,3	56,7
Rail	1063	46425	3,4	13,4
Air	5486	54398	17,7	15,7
Sea	25	837	0,1	0,2
Air + Road	81	515	0,3	0,1
Rail + Sea	219	14737	0,7	4,3
Rail + Road	132	382	0,4	0,1
Sea + Road	133	1228	0,4	0,4
Unspecified	3013	31015	9,7	9,0
<b>Sub sum</b>				
<i>Road</i>	21243	198036	68,4	57,3
<i>Rail</i>	1414	61544	4,6	17,8
<i>Air</i>	5567	54913	17,9	15,9
<i>Sea</i>	377	16802	1,2	4,9
<b>Total</b>	31049	345448	100	100

The transport mode is better completed than the type of transported material. It was usually correctly completed (9% unspecified only).

57% of packages are transported by road, thus representing the most popular transport mode, 18% of packages are transported by rail, 16% of packages are transported by air and 5% of packages are transported by sea.

In number of transports, 68% of transports are performed by road, 4% by rail, 18% by air, and 1% by sea. The low percentage associated to rail mode is due to the fact that a train is sometimes counted as one transport while it may include several wagons loaded with numerous radioactive material packages.

## 6. Analysis of the type of packages

The following list specifies the various types of packages selected for this survey (see Appendix 3 for the exhaustive list of replies), with the nomenclature used in the database specified in brackets.

Excepted (**E**)  
 Industrial type I (**i1**)  
 Industrial type II (**i2**)  
 Industrial type III (**i3**)  
 Industrial (**i**)  
 Excepted + industrial (**E + I**)  
 Type A (**A**)  
 Type A + excepted (**A + E**)  
 Type B (**B**)  
 Industrial + type A (**i + A**)  
 Fissile industrial package (**AF**)  
 Fissile industrial + fissile type A (**IF + AF**)  
 Bulk  
 Unspecified (**inc**)

Table 4 specifies the number of transports and transported packages depending on the type of package.

**Table 4. Number of transports and transported packages per type of package**

Type of package	Number of transport	Number of package	% Number of transport	% Number of package
Type B	1616	4187	5,20	1,21
Type A	15554	144539	50,10	41,84
Fissile Type A	71	9699	0,23	2,81
Industrial	604	18626	1,95	5,39
Industrial de type I	775	10533	2,50	3,05
Industrial de type II	1742	15576	5,61	4,51
Industrial de type III	168	36116	0,54	10,45
<i>Total on industrial caks (4 last lines)</i>	<i>3289</i>	<i>80851</i>	<i>10,60</i>	<i>23,40</i>
Industrial + Type A	51	1505	0,16	0,44
Industrial fissile + Type A fissile	20	93	0,06	0,03
Excepted	5354	50742	17,24	14,69
Excepted + Industriel	1	80	0,003	0,02
Type A + Excepted	2	11	0,01	0,003
Unspecified	4993	53569	16,08	15,51
Bulk	98	172	0,32	0,05
<b>Total</b>	<b>31049</b>	<b>345448</b>	<b>100</b>	<b>100</b>

As a total, the type A packages are most often transported, they represent 45% of packages and 50% of transports. Second, industrial packages represent 23% of packages and 10% of transports, excepted packages represent 15% of packages and 17% of transports. The type B packages are the less numerous, they only represent 1% of packages and 5% of transports. 16% of the transported packages are of "Unspecified" type.

Tables 5, 6 and 7 specify the number of transports and transported packages depending on the transport mode and type of package.

**Table 5. Number of transported packages per transport mode and type of package**

Transport mode	Type of package														
	B	A	AF	i	i1	i2	i3	i + A	iF + AF	E	E + i	A + E	inc	Bulk	Total
R	3489	102443	9699	2204	8955	12144	2531	1505	93	36322	80	11	16262	172	195910
F	399	91		2458	211	3415	33572						6279		46425
A	179	39924			1	2	13			14280					54399
M	50	292		495											837
AR	7	450			7					43			8		515
FM	48	946		12972	684					82			5		14737
FR	7			374									1		382
MR	7	393		123	675	15				15					1228
inc	1												31014		31015
<b>Total</b>	<b>4187</b>	<b>144539</b>	<b>9699</b>	<b>18626</b>	<b>10533</b>	<b>15576</b>	<b>36116</b>	<b>1505</b>	<b>93</b>	<b>50742</b>	<b>80</b>	<b>11</b>	<b>53569</b>	<b>172</b>	<b>345448</b>

R = Road, F = Rail, A = Air, M = Sea, AR = Air + Road, etc. , inc = unspecified

**Table 6. Simplified table of the numbers of transports and transported packages per type of package**

Transport mode	Type of package									
	B	A	i	E	i + A	E + i	A + E	Bulk	inc	Total
R	3489	102443	25834	36322	1598	80	11	172	16262	195910
F	399	91	39656						6279	46425
A	179	39924	16	14280						54399
M	50	292	495							837
AR	7	450	7	43					8	515
FM	48	946	13656	82					5	14737
FR	7		374						1	382
MR	7	393	813	15						1228
inc	1								31014	31015
<b>Total</b>	<b>4187</b>	<b>154238</b>	<b>80851</b>	<b>50742</b>	<b>1598</b>	<b>80</b>	<b>11</b>	<b>172</b>	<b>53569</b>	<b>3E+05</b>

R = Road. F = Rail. A = Air. M = Sea. AR = Air + Road. etc. . inc = unspecified

**Table 7. Simplified table of the numbers of transports and transported packages per type of package in percentage**

Transport mode	Type of package									
	B	A	i	E	i + A	E + i	A + E	Bulk	inc	Total
R	1.01	32.5	7.48	10.5	0.46	0.02	0.003	0.05	4.71	56.7
F	0.12	0.03	11.48						1.82	13.4
A	0.05	11.6	0.005	4.1						15.7
M	0.014	0.08	0.14							0.2



<b>AR</b>	0.002	0.13	0.00	0.01					0.002	0.1
<b>FM</b>	0.01	0.27	3.95	0.02					0.001	4.3
<b>FR</b>	0.002		0.11						0.0003	0.1
<b>MR</b>	0.00	0.11	0.24	0.004						0.4
<b>inc</b>	0.0003								8.98	9.0
<b>Total</b>	1.2	44.6	23.4	14.7	0.5	0.02	0.003	0.05	15.5	100

R = Road, F = Rail, A = Air, M = Sea, AR = Air + Road, etc. , inc = unspecified

Due to lacking declarations of gammagraph transports that are type B packages used to perform metallurgic inspections in industrial companies or work sites, the type B package category probably is widely underrun. To summarize, most packages are transported by road (57%), followed with rail transport for 18% of packages, and immediately after air transport for 16% of packages. Sea transports only concern 5% of the transported packages. The transport mode parameter is relatively well completed, only 9% are unspecified.

The most popular package transports are, in decreasing order, type A packages transported by road (32%), type A packages by air(12%), industrial type packages by rail (11%), excepted packages by road (10%), industrial packages by road (7%), excepted packages by air (4%), and industrial packages by sea (4%).

### 7. Analysis of the material category

The material categories are defined in accordance with the following list (the nomenclature used in the database is specified in brackets):

- LSA (L)
- LSA I (L1)
- LSA II (L2)
- LSA III (L3)
- SCO I (S1)
- SCO II (S2)
- S1+S2 (S)
- Special form source (FS)
- Others (A)
- Unspecified (inc)

Table 8 specifies the number of transports and transported packages depending on the material category.

**Table 8. Number of transports and transported packages per material category**

Material category	Number of transport	Number of package	% Number of transport	% Number of package
<b>LSA</b>	2	3	0.01	0.001
<b>LSA I</b>	2854	74410	9.2	21.5
<b>LSA II</b>	810	4321	2.6	1.2
<b>LSA III</b>	98	2118	0.3	0.6
<b>SCO</b>	4	37	0.01	0.01
<b>SCO I</b>	182	874	0.6	0.2
<b>SCO II</b>	532	6311	1.7	1.8
<b>Special form material</b>	644	686	2.1	0.2
<b>Other</b>	3390	16568	10.9	4.8
<b>Unspecified</b>	22533	240120	72.6	69.5
<b>Total</b>	31049	345448	100.00	100.000

The material category is not well populated in the database, 73% of transports and 69% of packages are declared as unspecified. Nevertheless, it appears that the number of LSA I material packages represents 21% out of 30% of packages populated. Few LSA II (1.2%) are listed and even less LSA III (0.6%).

Again, transport of sources accepted as special form in gammagraph packages may be widely underrun.

## 8. Usage type of the material

The list below specifies the various usage types of the material selected for this survey:

Medical (**M**)

Civil industry (**IC**)

Nuclear fuel cycle (**CN**)

Civil and nuclear research (**RCN**)

Unspecified (**inc**)

Table 9 specifies the number of transports and transported packages depending on the usage type of the material.

**Table 9. Number of transports and transported packages per usage type of the material**

Use	Number of Transport	Number of package	% Number of transport	% Number of package
Medical	3831	32152	12	9
Civil industry	1727	9652	6	3
Nuclear fuel cycle	3621	74041	12	21
Nuclear and civil research	1452	7283	5	2
Unspecified	20418	222320	66	64
<b>Total</b>	<b>31049</b>	<b>345448</b>	<b>100</b>	<b>100</b>

In more than 60% of cases, the usage type of the transported material is not completed. It is thus difficult to analyze this information.

Tables 10 and 11 specify the number of transports and transported packages depending on the usage type of the material and package type.

**Table 10. Number transported packages per usage type of the material and package type**

Use	Type of package
-----	-----------------

	A	A + E	AF	B	E	E + i	i	i + A	i1	i2	i3	iF + AF	inc	Vrac	Total
<b>Medical</b>	1723			394	35								30000		32152
<b>Civil industry</b>	3488			269	577	80	41	288	2573	2270			66		9652
<b>Nuclear fuel cycle</b>	3892			1658	2236		16342	16	7322	7146	34877		432	120	74041
<b>Nuclear and civil research</b>	1748	11		1450	589		93		277	804	16		2246	49	7283
<b>Unspecified</b>	133688		9699	416	47305		2150	1201	361	5356	1223	93	20825	3	222320
<b>Total</b>	144539	11	9699	4187	50742	80	18626	1505	10533	15576	36116	93	53569	172	345448

**Table 11. Percentage of transported packages per usage type of the material and package type against the total number of packages**

Use	Type of package									
	B	A	i	E	i + A	E + i	A + E	Vrac	inc	Total
<b>Medical</b>	0.1	0.5		0.01					8.7	9.3
<b>Civil industry</b>	0.1	1.0	1.4	0.2	0.08	0.02			0.02	2.8
<b>Nuclear fuel cycle</b>	0.5	1.1	19.0	0.6	0.005			0.03	0.1	21.4
<b>Nuclear and civil research</b>	0.4	0.5	0.3	0.2			0.003	0.01	0.7	2.1
<b>Unspecified</b>	0.1	41.5	2.6	13.7	0.4			0.001	6.0	64.4
<b>Total</b>	1.2	44.6	23.4	14.7	0.5	0.02	0.003	0.05	15.5	100

The usage type of the material is very incorrectly completed (64% unspecified), more specially with regard to type A and excepted packages. Type B packages that were declared are basically used for the fuel cycle and for civil and nuclear research. They should also be widely used for industrial and work site gammagraphy. Industrial packages are basically used for nuclear fuel cycle.

## 9. Conclusion

This survey provides interesting information, even if the figures should be considered with care, due to the non-exhaustiveness of the inventory of transport flows.

It highlights the ambiguity existing in the definition of the "transport" word. This word covers several meanings and the values provided by companies had to be corrected in order to better harmonize the set. It is safer to consider the number of transported packages which, in addition, is better populated in the database, instead of the number of transports.

This survey inventories 345,448 transported packages for 1997 on the French territory. The previous assessment performed more than ten years ago, resulted in a value of 300,000 packages transported each year. The rank order still remains correct, the number of packages actually transported each year in France is probably higher but does not exceeds 400,000 packages. The inventoried packages include exports, imports, domestic transports, but not transits.

The transport mode was quite well populated (9% unspecified only), 57% of packages are transported by road, which is the most popular transport mode, 18% of packages are transported by rail, 16% of packages are transported by air, and 5% of packages are transported by sea.

As for the transported packages, 45% are type A packages, 23% are industrial packages, 15% are excepted packages, and 1% are type B packages. In 16% of cases, the package type is not specified.

The most popular package transports are, in decreasing order, type A packages transported by road (32%), type A packages by air(12%), industrial packages by rail (11%), excepted packages by road (10%), industrial packages by road (7%), excepted packages by air (4%), and industrial packages by sea (4%).

To give some figures with regard to the number of transports, the survey inventories 31,049 transports, 68% by road, 4% by rail, 18% by air, and 1% by sea. The low percentage associated to rail mode is due to the fact that a train is sometimes counted as one transport while it may include several wagons, each loaded with numerous radioactive material packages.

If this survey has the credit to provide information with regard to the radioactive material transport flows in France, these figures should nevertheless be confirmed in the future via at least one more survey of the same type supported by a simpler questionnaire than the one used for this work.

An additional survey of the transport flows for gammagraph packages is also desirable.

**APPENDIX 1**

**Copy of the mail requesting a declaration of transport flows**



**INSTITUT DE PROTECTION ET DE SURETE NUCLEAIRE**

**DEPARTEMENT DE SECURITE DES MATIERES RADIOACTIVES**

*Service de Sûreté des Transports Radioactifs*

Fontenay-aux-Roses, August 12, 1998

Le Chef de Département  
DSMR/SSTR/FR/98-858

DESTINATAIRES

IN FINE

**Subject:Radioactive material transport flows**

Dear Sir,

In order to enrich the statistical database of radioactive material transport flows implemented by IPSN, as agreed with the French "Direction de la Sûreté des Installations Nucléaires", I would be grateful if you could transmit us the information concerning the radioactive material transports that you performed or had performed during the year 1997. This information will remain confidential.

We shall subsequently renew this request on a yearly basis.

In order to facilitate our yearly summary work, we propose to communicate this information in a format compatible with the enclosed template.

Please forward this information to:

M. le Chef du SSTR  
IPSN/DSMR  
BP n°6  
92265 FONTENAY AUX ROSES  
Telephone : 01 46 54 83 13  
Fax : 01 46 54 95 74  
E-mail :

françoise.rancillac@ipsn.fr

Expecting your reply,  
Yours Faithfully

D. FLORY

Enclosure: Yearly flow declaration template + help

COPY: M. MIGNON            DSIN  
         M. SERT                IPSN



Mme RANCILLAC IPSN

letrfli.doc

**Company or Department Name:**

Material	Place of departure	Place of arrival	Transport mode	Type of package	Name of package	Number of transports	Number of packages	Weight (kg)	Fissile weight (kg)	Total activity (Bq)	Material category	Usage type of material



## Help for completing the declaration of transport flow table

**Material:** Radionuclide type. In the case of UF<sub>6</sub>, specify the U235 enrichment. Also, specify whether uranium is derived from reprocessing for UO<sub>2</sub>, U<sub>3</sub>O<sub>8</sub>, UF<sub>6</sub>.

**Place of departure:** in case of a city or site abroad, specify the country.

**Place of arrival:** in case of a city or site abroad, specify the country.

**Transport mode:**

Road	: R
Rail	: F
Sea	: M
Air	: A

**Type of package:**

excepted	: E
industrial type I	: i I
industrial type II	: i II
industrial type III	: i III
type A	: A
type B	: B

**Number of transports:** number of transports performed between the place of departure and the place of arrival

**Number of packages:** total number of packages transported during the x above-mentioned transports

**Weight:** total weight transported during the x transports

**Material category:**

LSA I	: L1
LSA II	: L2
LSA III	: L3
SCO I	: S1
SCO II	: S2
Special form source	: FS
Others	: A

**Usage type of the material:**

medical	: M
civil industry	: IC
Nuclear fuel cycle	: CN
civil and nuclear research	: RCN

**A2.1. Exhaustive inventory of the various designations met in the "Material" column and correspondence with the nomenclature selected for calculations**

**A2.2. List of categories selected for the "Material" column in alphabetical order**

**A2.1. Exhaustive inventory of the various designations met in the "Material" column and correspondence with the nomenclature selected for calculations**

Am	Am
Am-Be	Am-Be
Am, Co, Cs	Am, Co, Cs
Am, Co, Pu, U	Am, Co, Pu, U
Am 241	Am
Am 241 Sr 90	Am, Sr
Ampoule	Divers
Ar 41	Ar
Ass. MOX	MOX
Autres produits	Divers
Autres produits U	U
B	B
Ba 133	Ba
Barrière Ther	Divers
BCL	B, Cl
Be 7	Be
Bi, Na, Co, Ni	Bi, Co, Na, Ni
Br 82 et Ar 41	Ar, Br
Cat 0	Divers
Cat II irr	Comb irr
Cat III	U
Cat III Pu	Pu
Cd, Pu, Sr	Cd, Pu, Sr
Ce, Co, U, Pu	Ce, Co, U, Pu
Céramique tritiée	Déchets gazeux
Cf	Cf
Cf 252	Cf
Cf 252 Eu 152 Ho 166m	Cf, Eu, Ho
Chambre à fusion	Divers
Chat. de plomb	Vide
Châteaux	Vide
Ci 36	Cl
Cm 244	Cm
Co	Co
Co, Ba	Ba, Co
Co, Cs, Am	Am, Co, Cs
Co, Cs, Ba	Ba, Co, Cs
Co, Cs, Ra, Sr	Co, Cs, Ra, Sr
Co 56	Co
Co 57	Co
Co 57 Ba 13	Ba, Co
Co 57, Cs 137	Co, Cs
Co 58, Zn 65, Sr 85, Xe 133, Zr 95, Cs 137	structure activée ou contaminée (Stru act ou cont)
Co 60	Co
Co 60/58 (ou Co 60 – Co 58)	Co
Co 60, Cf 252	Cf, Co
Co 60, Cs 137	Co, Cs
Co 60, Mn 54, Cr 51, Sn 113, Zr 95, Nb 95, Sb 105	Stru act ou cont
Coffret ECGS3	Divers
Combustible	Comb neuf
Cr 51	Cr
Cr 51 - Co 58 Co 60 – Fe 59	Co, Cr, Fe

Cray.MOX		MOX	
Cs	Cs		
Cs, Co	Co, Cs		
Cs, Co, Ba	Ba, Co, Cs		
Cs 137	Cs		
Cs 137 Co 60	Co, Cs		
Comb. irr. (ou Comb irr)	Comb irr		
Comb irr BR	Comb irr		
Comb irr PWR (900, 1300...)	Comb irr		
Com neuf UO2	Comb neuf		
Comb. Recher	Comb. Recher		
Combustibles irradiés	Comb irr		
Concentrés de tous types	Concentré U		
Contener	inc		
Coques	Déchets solides		
Cu	Cu		
Déchets	Déchets		
Déchets $\alpha$	Déchets alpha		
Déchets FA	Déchets FA		
Déchets FMA	Déchets FMA		
Déchets liquides	Déchets liquides		
Déchets solides	Déchets solides		
Déchets (URT)	Déchets (URT)		
Détecteurs nucléaires	Divers		
Divers	Divers		
Echantillon UNH	UNH		
Echantillon UO <sub>2</sub> F <sub>2</sub>	Divers		
Echantillons	Divers		
Echantillons App	Uapp		
Effluent (ou Effluents)	Déchets liquides		
Emballage vide	Vide		
Empty Container	Vide		
Empty Containers	Vide		
Eu, Cs, Co	Eu, Co, Cs		
Eu 152	Eu		
Eu 152, Cd 109	Cd, Eu		
Fe	Fe		
Fe 55	Fe		
Fe 55, Ba 133	Ba, Fe		
Fe/Ni/Cu/Np	Cu, Fe, Ni, Np		
Gammagraphe	Gammagraphe		
Gd 153	Gd		
Ge 68	Ge		
Hf 178	Hf		
Hg 203	Hg		
Ho 166m	Ho		
Huile	Déchets liquides		
I	I		
I 123	I		
I 131	I		
Ir	Ir		
Ir 192	Ir		
Ir 192 Co 60	Co, Ir		
Kr	Kr		
Kr 81 m	Kr		
Kr 85	Kr		
Kr 85 Xe 131 Xe 133	Kr, Xe		
Lingots de tous types		Divers	
Maquette	inc		
Mat activé	Stru act ou cont		
Mat.cont. (ou Mat contaminé)		Stru act ou cont	
Matériel contaminé + Chambres à fission		Stru act ou cont	
Matériel de laboratoire		Stru act ou cont	
Matériel divers (ou Matériels divers) (ou Divers matériels)		Stru act ou cont	
Matériel divers radioactif		Stru act ou cont	

Matière divers		
Matières Recyclables U Naturel		Unat
Md 97		Md
Minerais d'U		Concentré U
Mn 54		Mn
Mo 99		Mo
MONAZITE		Concentré U
MTR irradié		comb irr
MTR - RHF IR		comb irr
Multi gamma		divers
Na 22		Na
Ni		Ni
Ni 63		Ni
Nitrate d'uranyle		UNH
Nitrate Pu		Pu
Nitrates		UNH
Np 237		Np
NU		UNH
OCS 1		Stru act ou cont
OCS 2		Stru act ou cont
Oxyde d'uranium		UO2
Oxydes homogènes		UO2
Oxydes hétérogènes		UO2
P 32	P	
P. Activation	stru act ou cont	
P.O.N	divers	
Pastilles	UO2	
Poste de terre	Divers	
Poudre PuO2	PuO2	
Poudre UO2	UO2 poudre	
Prolongateurs	Divers	
Pu	Pu	
Pu, Am, Np	Am, Pu, Np	
Pu, Np, Cs	Cs, Np, Pu	
Pu,U235,Am	Pu,U235,Am	
Pu 239	Pu	
Pu 239 Am 241	Pu	
Pu 239, U 235	Pu, U	
PuO2	PuO2	
Pu/U	Pu, U	
Ra 226	Ra	
Ra-Be	Be, Ra	
Râtelier de piscine + gravats		Stru act ou cont
Rebut MOX		MOX
Résidus vitrifiés		Résidus vitrifiés
Résine		Déchets solides
Ru 103		Ru
Sealed source Co-60		Co 60 scellée
Sealed source Cs-137		Cs 137 scellée
Sn 113		Sn
Solution aqueuse U app. (0,2%)		Uapp
Solvants radioactifs		Déchets liquides
Source		Sources $\alpha$ $\beta$ $\gamma$
Source $\alpha$		Sources $\alpha$ $\beta$ $\gamma$
Source $\alpha$ $\beta$		Sources $\alpha$ $\beta$ $\gamma$
Source $\alpha$ $\beta$ $\tau$		Sources $\alpha$ $\beta$ $\gamma$
Source SNC		Sources $\alpha$ $\beta$ $\gamma$
Sr 85		Sr
Sr 90		Sr
Sr 90, Y 90		Sr, Y
Structures Phébus contaminées Cs 137		Stru act ou cont
Structures zircaloy contaminées Sb 125, Nb 95, Sn 113, Cr 51, Mn 54, Co 60		Stru act ou cont
T	T	
T, Cs	T, Cs	

T, I 125	T, I
Tc 99	Tc
Tétrafluorure d'uranium	UF4
Th	Th
Th Na	Th
ThO2	Th
Th 232	Th
Ti 201	Ti
Ti 204	Ti
U	U
Uapp	Uapp
Uenr	Uenr
U enr (4 et 7%)	Uenr
U mét 93%	Umét
U met. (copeaux)	Umét
U métal	Umét
U métal (lingot)	Umét
Unat	Unat
Unat + Uapp (ou U nat. U app)	Unat, Uapp
U naturel Np 235	Unat , Np
UF4 (ou UF <sub>4</sub> )	UF4
UF6 à 3,7	UF6 enr
UF6 à 4,1	UF6 enr
UF6 enr	UF6 enr
UF6 nat	UF6 nat
UNH	UNH
UNH 0,67%	UNH
UNH 1,00%	UNH
UO2	UO2
UO2 à 0,2%	UO2 app
UO2 à 2,2%	UO2 enr
UO2 à 4,25%	UO2 enr
UO2 à 4,32%	UO2 enr
UO2 à 19,95	UO2 enr
UO2 enr	UO2 enr
UO2 enrichi	UO2 enr
UO2/U3O8	UO2/U3O8
U/Pu (ou U,Pu)	Pu, U
U/Pu Mét.	Pu, Umét
Uranates	Uranates
Uranium	U
URT 0,77%	URT
URT 0,97%	URE
URT 1,43%	URE
URT 1,49%	URE
URT 1,66%	URE
U 235	U
U 235 < 5%	Uenr
U 235 93%	Uenr
U 235 19,80%	Uenr
U 238	U
U3O8	Concentré U
U3Si2	U
Vide (ou Vides)	Vide
Xe 133	Xe
Y 88	Y
Yb 169	Yb
Zm 65 - Co 51 Co 60 - Fe 55	Stru act ou cont

## A2.2. List of categories selected for the "Material" column in alphabetical order

Am	Hf
Am, Be	Hg
Am, Co, Cs	Ho
Am, Co, Pu, U	I
Am, Np, Pu	inc
Am, Sr	Ir
Ar	Kr
Ar, Br	Kr, Xe
B	Md
B, Cl	Mn
Ba	Mo
Ba, Co	MOX
Ba, Co, Cs	Na
Ba, Fe	Ni
Be	Np
Be, Ra	P
Bi, Co, Na, Ni	Pu
Cd, Eu	Pu, U
Cd, Pu, Sr	Pu, Umét
Ce, Co, Pu, U	PuO2
Cf	Ra
Cf, Co	Résidus vitrifiés
Cf, Eu, Ho	Ru
Cl	Sn
Cm	Sources $\alpha$ $\beta$ $\gamma$
Co	Sr
Co 60 scellée	Sr, Y
Co, Cr, Fe	Stru act ou cont
Co, Cs	T
Co, Cs, Eu	T, I
Co, Cs, Ra, Sr	Tc
Co, Ir	Th
Comb irr	Ti
Comb neuf	U
Comb recher	Uapp
Concentré U	Uapp, Unat
Cr	Uenr
Cs	UF4
Cs 137 scellée	Umét
Cs, Np, Pu	Unat
Cs, T	Unat, Np
Cu	UF6 enr
Cu, Fe, Ni, Np	UF6 nat
Déchets	UNH
Déchets alpha	UO2
Déchets FA	UO2/U3O8
Déchets FMA	UO2 app
Déchets gazeux	UO2 enr
Déchets liquides	UO2 poudre
Déchets solides	Uranates
Déchets (URT)	URE
Divers	URT
Eu	Vide
Fe	Xe
Gammagraphe	Y
Gd	Yb
Ge	

## APPENDIX 3

### Inventory of elements listed in the "Type of package" column and correspondence with the nomenclature selected for calculations

A	A	
A + iI	i + A	
A + iI + iIII	i + A	
AF	AF	
B	B	
BU	B	
C C32	B	
CC06 + DV01	B	
C1	i1	
CE	A	
Divers	inc	
E	E	
E+iI	E + i	
Excepté	E	
F 129	B	
Fût 200 L	i	
Fûts	i	
GB	AF	
i	i	
I	i	
i1	i1	
i2	i2	
i3	i3	
IF AF (ou AF IF, ou IF/AF, ou AF/IF)		iF + AF
iI & iIII (ou iII & iI)		i
iIII/A (ou A/iIII, ou A + iIII, ou iIII + A)		i + A
IND	i	
IP1	i1	
IP2	i2	
IP3	i3	
L2	i2	
L3	i3	
R	i1	
R 81	inc	
R84	inc	
RHF	AF	
SV 34	B	
TN 90	inc	
TN99	B	
TNSN	B	
TVB	inc	
Valise	i	
Valve	Vrac	
Vrac	Vrac	
1A 1EP	A + E	
1 iII 2A	i + A	
2A 32iII	i + A	
2 iI 2 iIII	i	
20 pieds	i	
***	inc	

APPENDIX 4

List of radioactive material transport shippers  
having communicated their transport flows in 1997

**AMERSHAM**  
**ANDRA**  
**BNFL SA**  
**CEP INDUSTRIE**  
**CETE DE LYON**  
**CETE DE BLOIS**  
**CIS BIO INTERNATIONAL**  
**COGEMA/BU**  
**COGEMA PIERRELATTE**  
**COMURHEX**  
**EDF**  
**EDF LES RENARDIERES**  
**EURODIF PRODUCTION**  
**EUROPA NUCLEAIRE TRANSPORTS**  
**FRAMATOME**  
**GAMMA SERVICE Recycling GmbH**  
**INTERCONTROLE**  
**MICHELIN**  
**MDS NORDION**  
**NCT**  
**RHODIA Chimie Terres Rares et Gallium**  
**SOTRIMO**  
**TRANSNUCLEAIRE**  
**TSR TRANSRAD**

**CEA de Bruyères-le-Chatel (CEB III)**  
 DSR/DTDS/Service SARI

**CEA Cadarache**  
 SGDC  
 DRN/DEC/SEI/BGC  
 SDOS

**CEA FAR**  
 DIR/UEP/SAR  
 SATE  
 FAR/DIR/US/SPRE  
 SDOS

**CEA Grenoble**  
 SPRSE  
 SPRSE  
 DTP/SECC  
 DAMERI/SAR/SAT

**CEA Saclay**  
 UGSP/SPR/SRI  
 DAMRI  
 DCC/DPE/CSSQ  
 UEGD/STTL

**CEA Valduc (CVA)**  
 DSTA/SPR



**ANNEX 2**

**MODIFIED TABLES OF THE REPORT  
GIVEN IN ANNEX 1**

**Table 2. Number of transports and transported packages per type of material globalized as: sources, uranium-based materials, plutonium-based materials, wastes,**

**empty packages, and miscellaneous and unspecified**

<b>Material</b>	<b>Number of transports</b>	<b>Number of packages</b>	<b>% Number of transports</b>	<b>% Number of packages</b>
Radioactive	403 820	598 467	98,44	82,57
Uranium	4302	82 388	1,05	11,37
Plutonium	291	3 073	0,07	0,42
Waste	1373	32 463	0,33	4,48
Empty casks	250	1 818	0,06	0,25
Unspecified	194	6548	0,05	0,90
<b>Total :</b>	<b>410 230</b>	<b>724 757</b>	<b>100,00</b>	<b>100,00</b>

**Table 3. Number of transports and transported packages per transport mode**

<b>Mode of transport &amp; combination</b>	<b>Number of transports</b>	<b>Number of packages</b>	<b>% Number of transports</b>	<b>% Number of package</b>
Road only	406104	605973	98,99	83,61
Rail only	912	46457	0,22	6,41
Sea	21	801	0,01	0,11
Air + Road	2709	55049	0,66	7,60
Rail + Sea	219	14766	0,05	2,04
Rail + Road	131	381	0,03	0,05
Sea + Road	133	1228	0,03	0,17
Unspecified	1	102	0,00	0,01
<b>Total :</b>	<b>410230</b>	<b>724757</b>	<b>100</b>	<b>100,00</b>
<b>Sub sum Road</b>	<b>409077</b>	<b>662631</b>	<b>99,7</b>	<b>91,4</b>
<b>Rail</b>	<b>1262</b>	<b>61604</b>	<b>0,3</b>	<b>8,4</b>
<b>Air</b>	<b>2709</b>	<b>55049</b>	<b>0,6</b>	<b>7,6</b>
<b>Sea</b>	<b>373</b>	<b>16795</b>	<b>0,1</b>	<b>2,3</b>

**Table 4. Number of transports and transported packages per type of package**

Type of package	Number of transports	Number of packages	% Number of transports	% Number of Packages
Type B	51325	53839	12,51	7,43
Type A	85685	218646	20,89	30,17
Type A fissile	71	11022	0,02	1,52
Industrial	4221	101838	1,03	14,05
Industrial + Type A	71	1629	0,02	0,22
Excepted	268026	334723	65,34	46,18
Unspecified	641	2722	0,16	0,38
Bulk	190	338	0,05	0,05
<b>Total :</b>	410230	724757	100,00	100,00

**Table 5. Number of transported packages per transport mode and type of package**

Mode of transport	Type of package											
	B	A	AF	I	i1	i2	i3	i + A	E	Un-specified	Bulk	Total
Road	53131	176652	10806	16921	8955	12144	2531	1598	320296	2601	338	605973
Rail	400	91		8737	211	3415	33572	31				46457
Sea	14	292		495								801
Road + air	202	40484		7	7				14330	19		55049
Rail + sea	78	950		12972	684				82			14766
Rail + road	7			374								381
Road + sea	7	177	216	123	675	15			15			1228
Unspecified										102		102
<b>Total :</b>	53839	218646	11022	39629	10532	15574	36103	1629	334723	2722	338	724757

**Table 6. Simplified table of the number of carried packages per type of package and by mode of transport**

Mode of transport	Type of package							
	B	A	I	E	i + A	Bulk	Unspecified	Total
Road	7,33	25,86	5,60	44,19	0,22	0,05	0,36	83,61
Rail	0,06	0,01	6,34	0,00	0,00	0,00	0,00	6,41
Sea	0,00	0,04	0,07	0,00	0,00	0,00	0,00	0,11
Road + air	0,03	5,59	0,00	1,98	0,00	0,00	0,00	7,60
Rail + sea	0,01	0,13	1,88	0,01	0,00	0,00	0,00	2,04
Rail + road	0,00	0,00	0,05	0,00	0,00	0,00	0,00	0,05
Road + sea	0,00	0,05	0,11	0,00	0,00	0,00	0,00	0,17
Unspecified	0,00	0,00	0,00	0,00	0,00	0,00	0,01	0,01
<b>Total :</b>	7,43	31,69	14,05	46,18	0,22	0,05	0,38	100,00

**Table 7. Number of transports and transported packages per material category**

Category of Material	Number of transports	Number of packages	% Number of transports	% Number of Packages
LSA	2	3	0,00	0,00
LSA I	2 854	74 410	0,70	10,27
LSA II	810	4 321	0,20	0,60
LSA III	98	2 118	0,02	0,29
SCO	4	37	0,00	0,01
SCO I	182	874	0,04	0,12
SCO II	532	6 311	0,13	0,87
Special form	123800	123800	30,18	17,08
Autres	3 390	16 568	0,83	2,29
Unspecified	278558	496315	67,90	68,48
<b>Total :</b>	410 230	724757	100,00	100,00

**Table 8. Number of transports and transported packages per Use type of the material**

Use type	Number of Transports	Number of packages	% Number of transports	% Number of packages
Medical	16 443	198597	4,01	27,40
Civil industry	380000	380000	92,63	52,43
Nuclear fuel cycle	5 776	120840	1,41	16,67
Civil and nuclear research	7 221	19299	1,76	2,66
Unspecified	790	6021	0,19	0,83
<b>Total :</b>	410 230	724757	100,00	100,00

**Table 9. Number of transported packages per Use type of the material and package type**

Use	Type of package								
	A	AF	B	E	i + A	i	Un-specified	Bulk	Total
Medical	136970		226	61401					198597
Civil industry	70000		5000 0	26000 0					380000
Nuclear fuel cycle	5960	11022	1765	2080	1629	97782	362	240	120840
Civil and nuclear research	4751		1395	9656		1141	2258	98	19299
Unspecified	965		453	1586		2915	102		6021
<b>Total :</b>	218646	11022	5383 9	33472 3	1629	101838	2722	338	724757

**Table 10. Percentage of transported packages per Use type of the material and package type against the total number of packages**

Use type of the material	Type of package							
	A	B	E	I + A	I	Unspecified	Bulk	Total

<b>Medical</b>	18,90	0,03	8,47	0,00	0,00	0,00	0,00	27,40
<b>Civil industry</b>	9,66	6,90	35,87	0,00	0,00	0,00	0,00	52,43
<b>Nuclear fuel cycle</b>	2,34	0,24	0,29	0,22	13,49	0,05	0,03	16,67
<b>Civil and nuclear research</b>	0,66	0,19	1,33	0,00	0,16	0,31	0,01	2,66
<b>Unspecified</b>	0,13	0,06	0,22	0,00	0,40	0,01	0,00	0,83
<b>Total :</b>	31,69	7,43	46,18	0,22	14,05	0,38	0,05	100,00

## ANNEX 3

# QUESTIONNAIRE SENT TO RADIOGRAPHERS

## INSTITUT DE RADIOPROTECTION ET DE SÛRETÉ NUCLÉAIRE

SSTR/02-453

Fontenay aux Roses, le

Affaire suivie par K. BEN OUAGHREM

IN FINE

Objet : **Doses reçues lors du transport d'appareils de radiographie gamma**

Monsieur,

Dans le cadre d'une étude européenne visant à évaluer l'impact dosimétrique des flux de transport de matières radioactives, nous souhaiterions connaître les doses reçues par vos chauffeurs lors des seules activités de transport.

Dans ce but, nous vous demandons d'effectuer pendant 2 mois un suivi dosimétrique des conducteurs des véhicules de transport de colis de matières radioactives. Les modalités de ce suivi sont décrites en annexe.

Ces informations resteront confidentielles.

Par ailleurs vous voudrez bien noter que, **si vous n'effectuez que des transports d'appareils de radiographie gamma**, votre réponse via le formulaire du présent courrier, **vous dispense de répondre à l'enquête FLUCIS** qui vous a été adressée par le courrier SSTR/KBO/FLM/01-1077 adressé en janvier 2002.

**Je vous prie d'agréer, Monsieur, l'expression de mes salutations distinguées.**

D. FLORY  
Chef du DSMR

PJ : 1 formulaire de réponse, des feuilles d'identification et des DOSIFILMS ou DOSICARD selon le type de suivi.  
Copie : M. SERT IRSN/DSMR/SSTR  
Mme LIZOT IRSN/DSMR/SSTR  
M. BRENOT IRSN/DPHD/SEGR

---

**Département de Sécurité des Matières Radioactives**

Service de sécurité des transports radioactifs  
Echelon d'analyse de la sûreté des emballages

Courrier : B.P. 17 - 92262 FONTENAY-AUX-ROSES Cedex FRANCE - Tél. : (33) 01 46 54 96 24 - Fax : (33) 01 46 54 95 74  
DSMR/2002-010 Rev.0 December 2002  
Siège social : 77-83, avenue du Général-de-Gaulle - 92140 CLAMART - Standard : (33) 01 46 54 88 88 - RCS Nanterre B 440 546 018

**Ce que vous avez à faire :**

2 méthodes de suivi sont possibles : par DOSIFILM (méthode 1) ou par DOSICARD (méthode 2). Suivez uniquement les modalités correspondant au type de suivi qui a été négocié avec Monsieur BEN OUAGHREM par téléphone. Votre N° de méthode est rappelé dans l'objet du présent courrier.

**Méthode 1 - suivi par DOSIFILM :**

0- Sélectionnez parmi vos conducteurs, ceux qui effectuent le plus grand nombre de transports d'appareils de radiographie gamma en colis de type B.

1- Attribuez à chacun des chauffeurs sélectionnés : **2** DOSIFILMS parmi ceux transmis dans le présent courrier.

- **1** DOSIFILM (**DOSC**) doit suivre le chauffeur au cours de toutes ses activités (transport et radiographie).

- **1** DOSIFILM (**DOSV**) doit suivre le chauffeur uniquement pendant ses activités de transport.

Afin de simplifier ces opérations, nous limiterons l'activité de transport à la conduite du véhicule chargé d'un appareil (c'est-à-dire que nous ne prenons pas en compte les actions de chargement et de déchargement). Si le chauffeur utilise toujours le même véhicule, le DOSIFILM **DOSV** peut être placé directement dans le véhicule au plus proche du conducteur, entre le conducteur et le lieu d'arrimage des appareils (**DOSV** fixé derrière le siège conducteur par exemple).

**ATTENTION** : ce protocole n'est valable que si le temps de présence du chauffeur est du même ordre que celui de l'appareil dans le véhicule. Si cette condition ne peut pas être satisfaite, prenez contact avec Monsieur BEN OUAGHREM IRSN/DSMR/SSTR afin d'envisager un nouveau protocole.

2- Pour chacun des DOSIFILMS attribués, renseignez la fiche d'identification en précisant bien le nom et le prénom du chauffeur.

3- Renseignez le formulaire de réponse ci-joint.

4- Après un minimum de 2 mois d'activités, adressez le formulaire de réponse, les DOSIFILMS et les feuilles d'identification à :

Monsieur BEN OUAGHREM  
IRSN/DSMR/SSTR BP N° 17 92262 FONTENAY AUX ROSES  
N° de téléphone : 01 46 54 85 43  
N° de fax : 01 46 54 95 74  
E-mail : [karim.benouaghrem@irsn.fr](mailto:karim.benouaghrem@irsn.fr)

**Méthode 2 - suivi par DOSICARD :**

1- Attribuez au conducteur qui effectue le plus grand nombre de transports de colis de matières radioactives : le DOSICARD (**DOC**) transmis dans le présent courrier.

2- Renseignez la fiche d'identification en précisant bien le nom et le prénom du chauffeur.

3- Renseignez le formulaire de réponse ci-joint.

4- Le chauffeur allume le DOSICARD **DOC** juste avant de monter à bord de son véhicule (colis chargé dans le véhicule).

Pour allumer le DOSICARD **DOC** : appuyer sur l'astérisque \* située en bas à droite.

L'astérisque dessinée sur l'écran de contrôle clignote.

Une fois son transport terminé :

5- Le chauffeur quitte son véhicule

6- Le chauffeur note sur la table d'enregistrement jointe au courrier la dose reçue indiquée sur le DOSICARD **DOC**.

7- Le chauffeur éteint le DOSICARD **DOC**.

Pour éteindre le DOSICARD **DOC** : appuyer sur l'astérisque \* située en bas à droite. L'astérisque dessinée sur l'écran de contrôle se fige.

8- Après un minimum de 2 mois d'activités, adressez le formulaire de réponse, la table d'enregistrement de dose, le DOSICARD et les feuilles d'identification à :

Monsieur BEN OUAGHREM  
IRSN/DSMR/SSTR BP N° 17 92262 FONTENAY AUX ROSES  
N° de téléphone : 01 46 54 85 43  
N° de fax : 01 46 54 95 74  
E-mail : [karim.benouaghrem@irsn.fr](mailto:karim.benouaghrem@irsn.fr)

Liste des destinataires :  
Monsieur Jean Claude GODIN  
Madame Françoise GRESSET  
Monsieur Fernando DE ABREU  
Monsieur MARCHAND  
Monsieur LARROQUE

**IRSN**

CEGELEC  
INSTITUT DE SOUDURE  
AGRETEST (Porcieu)  
PLS CONTROLE  
CABINET SERRAIN





<b>R01</b>	<b>Appareils de radiographie gamma en colis de type B</b>	
R02	Raison sociale	
R03	Département	
R04	Correspondant	
R05	N° de téléphone	
RC	<b>1- Nombre d'appareils détenus</b>	
R06	- chargés d'Iridium 192	
R07	- chargés de césium 137	
RC	<b>2- Nombre de mouvements annuels moyens pour un appareil représentatif / pour l'ensemble des appareils (1 tir chez le client = 1 aller + 1 retour = 2 mouvements de l'appareil)</b>	
R08	- pour tirs radiographiques chez le client	
R09	- pour intervention ou déplacement en interne société	
R10	- pour maintenance ou rechargement chez le constructeur	
R11	- en France	
R12	- DOM TOM	
R13	- à l'étranger	
R14	- préciser le ou les pays	
R15	- par la route exclusivement	
R16	- par voie aérienne (route comprise)	
R17	- par voie ferrée (route comprise)	
R18	- par voie maritime (route comprise)	
R19	- Nombre de kilomètres parcourus par un appareil sur un an	
R20	- Dose individuelle maximale reçue en un an par un conducteur (mSv)	
RC	<b>3- Conditions de réalisation de la mesure de dose transport (répondre par oui ou par non)</b>	
R21	- Dans le véhicule, temps de présence du conducteur = temps de présence de la source (si non, indiquez la moyenne de temps pour chacun d'eux)	
R22	- L'appareil de mesure du débit de dose a été placé derrière au dos du siège conducteur (si non, précisez où)	
R23	- Indiquez la période d'essai (en jours)	
R24	- Nombre de km parcourus sur la période	
R25	- Les activités durant cette période ont-elles été représentatives (si non, précisez la tendance par rapport aux valeurs représentatives)	
RC	<b>4- Commentaires ou compléments d'information que vous jugez utile de préciser. Indiquez notamment les difficultés que vous avez pu rencontrer en termes de faisabilité lors de ce suivi</b>	
R26		

**ANNEX 4**

**REPORT FROM CEPN ON DOSES TO THE  
PUBLIC**

**EVALUATION OF PUBLIC EXPOSURES  
ASSOCIATED WITH THE TRANSPORTATION  
OF RADIOACTIVE MATERIALS IN FRANCE**

Authors : S. LEPICARD, T. SCHNEIDER

Date : November 2002  
(*Final*)

Références : NTE/02/35  
IRSN Contrat N°DA 21654/ CA 11001031  
CEPN C.593

Diffusion : IRSN

## TABLE OF CONTENTS

	INTROduction
	1. Collective doses for the public
1.1	Nuclear fuel cycle
1.2	Medical Sources
1.3	Civil industry and civil nuclear research
1.4	Synthesis of the collective doses estimated for the public
	2. individual exposures for hypothetical exposure scenarios
2.1	Calculation bases
2.2	Nuclear fuel cycle
2.3	Medical sources
2.4	Radioactive wastes (nuclear fuel cycle and civil research and industry)
2.5	Synthesis of individual doses estimated for public
	3. Conclusion
	ANNEX
	REFERENCES



## Introduction

This study is a contribution to the European co-operation project “Statistics on the transport of radioactive materials and statistical analyses” co-ordinated by the National Radiological Protection Board (NRPB, UK).

The objective of this study was to evaluate the doses on the public (general population) associated with the transportation of radioactive materials in France. Data on transport flows in France for the year 1997 were considered. Complementary information were also taken from the year 2000 data. Assessments were performed separately for the different types of transported materials, namely:

- Radioactive materials being a matter of the nuclear fuel cycle,
- Radioactive materials used for medical purposes,
- Radioactive materials used in civil industry,
- Radioactive materials used civil nuclear research.

For practical reasons relating to the lack of information on the available data on transport flows in France, it was not always possible to clearly differentiate between these three major categories, and some overlapping might have occurred in the calculations by reporting the same transport several times in different categories, resulting in a general overestimation of the collective doses.

Complementarily, individual doses of the public have been estimated for some relevant transport types, considering different hypothetical scenarios of exposure.





## 1. COLLECTIVE DOSE FOR THE PUBLIC

### 1.1 Nuclear fuel cycle

Collective doses to the public (general population) associated with the transportation of radioactive materials being a matter of the nuclear fuel cycle have been evaluated in France in the framework of the “ExternE” European project [1]. The results were provided on the basis of the French nuclear fuel cycle and technologies of the 1990’s, and considering five reference sites for electricity generation (1 300 MWe Pressurised Water Reactors), chosen to represent the total nuclear fuel cycle as it was existing by 1995. In ExternE, the transportation of material between sites has been considered as a separate fuel cycle stage. It included material transported for the fuel production, the actual fuel and the waste generated during the cycle.



**Figure 1. Locations of the major French nuclear fuel cycle facilities and reference sites for 1 300 MWe PWR**

In France, radioactive materials associated with the nuclear fuel cycle are transported by road or rail, following the approved safety practices of the International Atomic Energy Agency (IAEA).

Collective doses associated with the transportation operations were calculated using the computer code developed by the IAEA (INTERTRAN), on the basis of external exposure from the vehicle containing the radioactive material, the content of the material transported, the type of container, the mode of transport (road or rail), the distance travelled and the number of vehicle stops at public rest stations along the highway (for road transportation). The calculations presented in this study do not include accidental situations. Detailed main parameters and input data used to calculate doses with INTERTRAN are given in [2]. The distances associated with the electricity generation stage (fuel assemblies, spent fuel and reactor waste) are an average value for 5 references sites considered for the French nuclear fuel cycle. Transport flows and shipments characteristics correspond to the data available for the year 2000 [6].

For wastes transportation to the CSA, the results from a specific study have been used [3], considering an annual flux of 1 355 transports to the CSA [6]. In 1995 data, about 20% of these transports were associated with the civil nuclear research (CEA). In the absence of available information, this ratio was kept in the present evaluation.

**Table 1. Relevant characteristics and transport flux for the radioactive material transported in the French nuclear fuel cycle**

Material transported	Mod	TI <sup>(2)</sup>	Aver. dist. travel.	No of vehicles or wagons per year	Population density			Repartition of the trip			Time stop
					rural	suburb.	urban	rural	suburb.	urban	
yellow cake (U = 70%)	rail	0.1	90 km	380	50	700	6800	90%	7.5%	2.5%	0
UF <sub>4</sub>	road	0.1	200 km	425	50	700	6800	90%	7.5%	2.5%	0
UF <sub>6</sub> natural	road	1	5 km	109	300	0	0	100%	0%	0%	0
UF <sub>6</sub> enriched	road	2	5 km	177	300	0	0	100%	0%	0%	0
fuel assembly (UO <sub>2</sub> +assembly)	road	6,5	620 km <sup>(1)</sup>	196	300	0	0	100%	0%	0%	0
spent fuel assembly	rail	11	450 km <sup>(1)</sup>	203	50	700	6800	90%	7.5%	2.5%	0.001

Error! Reference source not found. (cont.). **Relevant characteristics and transport flux for the radioactive material transported in the French nuclear fuel cycle**

Material transported	Mod	TI <sup>(2)</sup>	Aver. dist. travel.	No of vehicles or wagons per year	Population density			Repartition of the trip			Time stop
UO <sub>2</sub> (NO <sub>3</sub> ) <sub>2</sub> (from reprocess.)	rail	3	900 km	230	50	700	6800	90%	7.5%	2.5%	0.001

(1) average distance

(2) transport index: dose rate at 1m from the packages in 10<sup>-2</sup> mSv/h

Collective doses associated with the French nuclear fuel cycle for the year 1997 were derived from the results presented in [1] and [2], assuming a nuclear electricity generation of 376 TWh in 1997. Wastes transports have been treated on a different way, as presented before. All results are presented in table 2. The total collective dose for the public is estimated to be about 388 man.mSv for the transports associated with the nuclear fuel cycle.

**Table 2. Collective doses to the public associated with transportation stages in nuclear fuel cycle**

Material transported	Collective dose (man.mSv) France, year 1997
Concentred ore	3,42E-03
UF <sub>4</sub>	2,03E-01
UF <sub>6</sub> natural	1,25E-02
UF <sub>6</sub> enriched	8,79E-02
UO <sub>2</sub> fuel assembly	1,60E+02
Spent fuel	1,06E+01
UO <sub>2</sub> (NO <sub>3</sub> ) <sub>2</sub>	3,37E+00
Radioactive wastes	2,14E+02
<b>Total</b>	<b>3,88E+02</b>

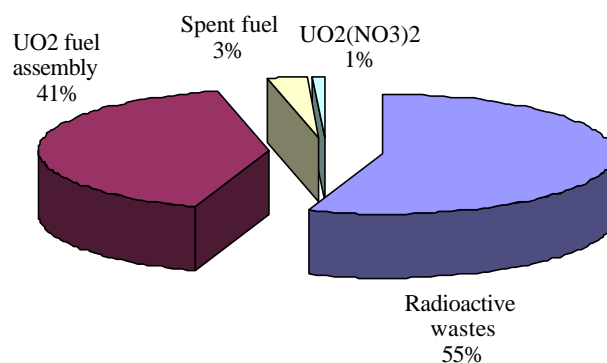

**Figure 2. Distribution of total collective doses associated with the transports of nuclear fuel cycle**

### 1.2 Medical Sources

The transport of medical sources in 1997 is estimated to be approximately 164 793 packages, of which 30 000 are of unspecified type in IRSN database [5]. The evaluation of collective doses to the public associated with the transportation of radioactive sources for medical purpose was based on a previous study on road accidents involving Type-A packages [5]. Complementary information related to the main Type-A packages in France have been obtained from SCHERING CIS-BIO International for the year 2000 [6]. The transport of sources from SCHERING CIS-BIO International (French producer of medical sources) which represents more than 70% of Type-A transports is supposed to be representative of all transports of medical sources in France. The distribution among all destination types (Airport, Paris, France and European) is supposed to be the same for 1997 as for 2000.

In the study [5] it was assumed that an average of 17 packages were carried in a van (weighted by the distance), keeping in mind that the distribution may range from a few numbers to 165 packages/van. Data from 2000 [6] tends to show that this figure should be closer to 46 packages per vehicle (average on all destination types). The related road transport of these medical sources was finally estimated to be about 1.2 million km/year, assuming an average number of packages per vehicle of 46. The assumption is made that all packages are transported in commercial vans. Detailed input data for collective dose calculations are presented in table 3.

**Table 3. Characteristics of the transport of medical sources in France – year 1997**

Destination	Nb transports	Nb packages	Range of TI (vehicle)	Aver. Nb of packages /transport
Airport	938	36 609	5-40	39
Paris	469	9 829	2-20	21
France (Paris excepted)	1 876	44 004	10-40	23
Europe	469	46 528	15-50	99
<b>Total</b>	<b>3 751</b>	<b>136 970</b>		

Calculation of collective doses associated with the transport of these packages were performed with INTERTRAN 2 [7].

**Table 4. Collective doses for the public, associated with the Type-A packages by SCHERING CIS-BIO International**

Destination	Fraction in zone (%)			Unit collective dose (man.Sv per km.TI)
	Rural	Sub-urban	Urban	
Airport	0	80	20	3,27E-07
Paris	0	20	80	1,14E-06
France (Paris excepted)	70	20	10	1,55E-07
Europe	90	7	3	4,91E-08

<sup>†</sup> Assuming that the dose rate at 1m of the vehicle can not exceed 0.2 mSv/h

The total collective dose associated with the transport of radioactive sources for medical purposes in France in 1997 is estimated from about 1 30 to less than 3 200 man.mSv.

### 1.3 Civil industry and civil nuclear research

IRSN database on radioactive transports in France in 1997 [4] have been used to identify transport flows of each type of packages: Type-A, Type-B, Industrial (IP) and Excepted packages (E) associated with civil industry and civil nuclear research. Complementary transports for these type of packages were also considered from 2000 data.

**Table 5. Transport flows associated with civil industry**

Package type	Total transports of package type	Dose rate at 1m of shipment (mSv/h)
A	70 000	0.002 <sup>†</sup>
B	50 000	0.004 – 0.01 <sup>‡</sup>
E	260 000	0

<sup>†</sup> Value for gamma density gauges

<sup>‡</sup> Value for gammagraphs

**Table 6. Transport flows associated with civil nuclear research**

Package type	Total transports of package type	Dose rate at 1m of shipment (mSv/h)
A	1630	0.2 <sup>†</sup>
B	433	0.2 <sup>†</sup>
E	4223	0
IP	242	0.2 <sup>†</sup>
Unspecified	581	0.2 <sup>†</sup>
Miscellaneous	98	0.2 <sup>†</sup>

<sup>†</sup> Derived from regulatory limit dose rate at 2m (0.1 mSv/h)

### Methodology for collective dose evaluation

In view of assessing the collective doses for the public associated with these transports, INTERTRAN 2 software was used by considering a set of “reference itineraries” for road transportation in France. This set was elaborated on the basis of the major city-poles identified above. These itineraries are described hereafter in table 7.

**Table 7. Reference itineraries for collective dose evaluation**

Itinerary N°	Departure	Destination	Total distance (km)	Rural zone	Sub-urban zone	Urban zone	Minimum stop time per trip (h)	Stops frequency (h/km)	Fraction urban during rush	Fraction urban on city streets	Fraction rural and sub-urban on freeways
T1	Fleurus/Amersham	Paris and suburbs	230	90%	5%	3%	0,25	8,30E-04	0%	30%	90%
T2	All	All	250	58%	40%	2%	0,10	8,30E-04	50%	80%	60%
T3	Valduc	Paris and suburbs	320	94%	3%	3%	0,25	8,30E-04	0%	70%	90%
T4	Valduc	CSA	130	85%	12%	3%	0,00	8,30E-04	0%	5%	70%
T5	Paris and suburbs	Marcoule	650	95%	3%	2%	0,50	8,30E-04	0%	0%	95%
T6	Paris and suburbs	Bruyères le châtel	26	77%	20%	3%	0,00	8,30E-04	0%	95%	0%
T7	Valduc	Cadarache	515	95%	4%	1%	0,50	8,30E-04	0%	1%	85%
T8	Paris and suburbs	Cadarache	760	95%	3%	2%	0,50	8,30E-04	0%	1%	90%
T9	Paris and suburbs	Paris and suburbs	47	45%	3%	52%	0,00	8,30E-04	75%	95%	85%



Table 8 presents the collective doses calculated with INTERTRAN 2 for all itineraries described before, considering a unit transport index (TI = 1).

**Table 8. Collective dose per itinerary – results from INTERTRAN 2**

Itinerary N°	Collective dose per trip (man.Sv per unit TI)
T1	$2.18 \times 10^{-6}$
T2	$4.65 \times 10^{-6}$
T3	$4.77 \times 10^{-6}$
T4	$8.92 \times 10^{-7}$
T5	$2.74 \times 10^{-6}$
T6	$8.25 \times 10^{-7}$
T7	$2.8 \times 10^{-6}$
T8	$3.3 \times 10^{-6}$
T9	$7.72 \times 10^{-5}$

All flows from IRSN database have been related to each of these itineraries. Dose rates at 1m of shipment which have been considered for different transports are presented in tables 5 and 6.

### Results

Collective doses for the public have been calculated for all types of packages quoted in the IRSN database, according to the methodology presented above<sup>1</sup>. For packages not exactly quoted as “A”, “B”, “E” or “IP” (cells presented in italic characters in table 9), calculations were performed by considering a dose rate at 1m of shipment derived from the regulatory limit of 0.1 mSv/h at 2m as a conservative approach.

<sup>1</sup> For civil industry, due to missing information on itineraries, results for 70000 Type-A and 50000 Type-B respectively were extrapolated from data obtained with a smaller number of transports for which itineraries were better known.

**Table 20. Collective doses associated with the transport of radioactive packages for civil industry**

Package type <sup>†</sup>	Total number of transports	Total collective dose in person.Sv (min – max)
A	70 000	$6.5 \times 10^{-2}$
B	50 000	$5.8 \times 10^{-1} - 1.45$
E	260 000	0
<b>Total</b>		<b><math>6.4 \times 10^{-1} - 1.45</math></b>

<sup>†</sup> Package types as quoted in the IRSN database

The total collective dose associated with the transport of radioactive packages for civil industry is estimated to be about 640 person.mSv to 1450 person.mSv.

**Table 21. Collective doses associated with the transport of radioactive packages for civil nuclear research**

Package type <sup>†</sup>	Total number of transports	Total collective dose in person.Sv (min – max)
A	1630	$7.76 \times 10^{-2}$
B	433	$2.89 \times 10^{-2}$
E	4223	0
IP	242	$1.98 \times 10^{-2}$
Unspecified	581	$5.40 \times 10^{-2}$
Miscellaneous	98	$9.11 \times 10^{-3}$
<b>Total</b>		<b><math>1.89 \times 10^{-1}</math></b>

<sup>†</sup> Package types as quoted in the IRSN database

The total collective dose associated with the transport of radioactive packages for civil nuclear research is estimated to be about 200 person.mSv.

#### 1.4 Synthesis of the collective doses estimated for the public

Table 14 summarises the collective doses estimated for the public, associated with the transport of radioactive materials in France in 1997. The total collective dose ranges from 2 to 5 person.Sv, the major contribution (more than 52% of total) being related to the medical purposes. It must be noted that due to the lack of information in the transport database, some transports might have been accounted several times and the resulting figures presented in Table 14 must be taken as overestimates of total collective exposures.

**Table 22. Summary of total collective doses for public – Transport of radioactive materials, France, 1997**

Related industry	Total collective dose in person.mSv
Nuclear fuel cycle	388
Medical purposes	1300-3168
Civil industry	640-1450
Civil nuclear research	189
<b>Total</b>	<b>2515-5195</b>

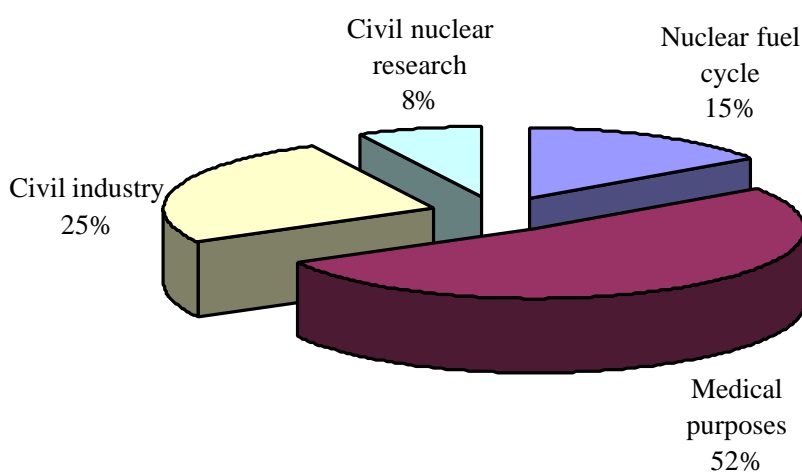

**Figure 19. Distribution of total collective dose for the public associated with the transports of radioactive materials (France, 1997)**

2. INDIVIDUAL EXPOSURES FOR HYPOTHETICAL EXPOSURE SCENARIOS

2.1 Calculation bases

Individual doses for public have been evaluated in previous studies for different types of transports. When available, these results have been collected and are presented in this report.

For transports which have not been subject of individual doses calculations until now, an attempt was made to give a rough appraisal of what such doses could be, by considering hypothetical exposure scenarios. The results obtained can not be taken as realistic critical group exposure estimates, but can serve as a basis for the identification of transports which should be subject of in-deeper analysis in the future.

As regards air transportation, different existing studies have been consulted in order to find elements for individual doses estimates in air-transit areas [8] [9] [10], but data was not sufficient to derive any scenario.

2.2 Nuclear fuel cycle

**Exposure along railways**

**Spent fuel – Scenario 1**

A study [11] performed by IRSN in 1999 presents calculations of doses for the public associated with the transportation of spent fuel casks by rail from nuclear power plants to the Valognes rail terminal, before these casks are transported (by road) from Valognes to the reprocessing plant located in La Hague. All casks coming from French nuclear plants converge in Sotteville terminal before being transported from Sotteville

to Valognes. This last rail section can consequently be considered as the most penalising one in terms of individual exposure of the population living along the railway, because all spent fuel casks will be transported on this itinerary.

Considering a flux of 150 spent fuel casks transported yearly from French power plants to La Hague (data from IRSN database), the dose received by an hypothetical individual standing along the railway at a distance of 30 m, between Sotteville and Valognes terminals, was estimated to be less than 0.8  $\mu\text{Sv}/\text{year}$  (1.1  $\mu\text{Sv}/\text{year}$  for a upper annual flux of 200 casks including transport from foreign power plants).

## Vitrified wastes – Scenario 2

Based on the results from the study [6] performed by IRSN for spent fuel casks between Valognes and Sotteville rail terminal, the exposures of an hypothetical individual standing along the railway in the vicinity of Valognes terminal after departure of trains conveying vitrified wastes casks at a distance of 30 m were evaluated.

Transport index of vitrified wastes shipments are in the range of 10-15. One cask (TN28) is transported in each train convoy. A total of 10 vitrified waste shipments is transported yearly from Valognes (data from IRSN database).

The corresponding dose is estimated to be in the range from 0.05  $\mu\text{Sv}/\text{year}$  (for TI = 10) to 0.08  $\mu\text{Sv}/\text{year}$  (for TI = 15).

## $\text{UO}_2(\text{NO}_3)_2$ LR 65 containers – Scenario 3

The exposure of an hypothetical individual standing along the railway in the vicinity of Valognes terminal after departure of trains conveying LR 65 containers (uranium oxide from reprocessing) at a distance of 30 m from railways was evaluated.

A single LR 65 containers is transported on each wagon. The transport index of the wagon is taken to be 3. A total number of 239 containers is supposed to be transported a year.

Based on the results from the study [11] performed by IRSN for spent fuel casks between Valognes and Sotteville rail terminal, the dose associated with the transport LR 65 containers is estimated to be about 0.4  $\mu\text{Sv}$ .

### Exposures during train stops

## Sotteville terminal – Scenario 4

Convoys of spent fuel may stay in the rail terminal of Sotteville for 10-12 hours in average. The dose received by an hypothetical individual standing in buildings of the terminal at distances of 40 and 100 m respectively was estimated, considering a total transfer of 150 spent fuel casks. A shielding factor of 0.1 was also considered, stating that the hypothetical individual would stay inside buildings. Dose rate (DR) at given distances (d) from shipment was calculated by the following formulae, assuming the shipment of characteristic dimension ( $\lambda$ ) can be considered as a point source for such values of d.

$$\text{DR}(d) = \text{DR}(1\text{m}) \cdot \frac{\left(1 + \frac{\lambda}{2}\right)^2}{\left(d + \frac{\lambda}{2}\right)^2}$$

with  $\lambda$  and d in meters.

$\text{DR}(1\text{m}) = 100 \mu\text{Sv}/\text{h}$  corresponds to the dose rate at a distance of 1m from shipment. Characteristic dimension of spent fuel casks is taken to be 6 m.

**Table 12. Doses associated with “train stops in Sotteville terminal” scenario – Spent fuel**

Distance from shipment	Time stop for each shipment	Dose for 1 shipment <sup>†</sup>	Total annual dose <sup>†</sup> (150 shipments)
40 m	10 h	0.86 $\mu$ Sv	130 $\mu$ Sv
	12 h	1.03 $\mu$ Sv	150 $\mu$ Sv
100 m	10 h	0.15 $\mu$ Sv	20 $\mu$ Sv
	12 h	0.18 $\mu$ Sv	30 $\mu$ Sv

<sup>†</sup> Assuming a shielding factor of 0.1 for people inside buildings

Doses associated with such a scenario are in the order of magnitude of 0.1-1  $\mu$ Sv for one shipment of spent fuel, corresponding to extreme values ranging from 20 to 150  $\mu$ Sv/year if considering 150 shipments per year (respectively 30 to 200  $\mu$ Sv/year for upper annual flux of 200 casks).

### Sotteville terminal – Scenario 5

The Sotteville terminal has several bridges where people can stay. Assuming that an hypothetical individual may stand for 30 minutes in his car on a bridge under which the charged wagon is stopped, the corresponding dose was calculated on the basis of a minimum distance of 2 m from the shipment and a dose rate equal to the dose rate at 1 m of the surface of shipment (eg. 100  $\mu$ Sv/h), given the shortness of the considered distance as compared with the characteristic dimension of the cask (6 m). An shielding factor of 0.1 was also considered for the protection of bridge concrete and car.

From this, the dose resulting from the exposure to a single shipment of spent fuel was estimated to be:  $D = 0.1 \times 0.5 \times 100 = 5 \mu$ Sv.

### Exposure during road stops

### Spent fuel – Scenario 6

During the road transportation between Valognes terminal and La Hague reprocessing plant, it is supposed that the convoys (trucks) may be stopped for an average of 2 minutes at a light. Considering an hypothetical individual standing in a building at a reference distance of 10 m from the shipment, the corresponding dose was calculated for the annual number of spent fuel shipments.

The dose rate was estimated on the same basis as previously described (see 0). Results are presented in table 13.

**Table 13 Doses associated with “truck stops at road light” scenario – Spent fuel**

Distance from shipment	Time stop for each shipment	Dose for 1 shipment <sup>†</sup>	Total annual dose <sup>†</sup> (150 shipments)
10 m	2 minutes	0.03 μSv	5 μSv

<sup>†</sup> Assuming a shielding factor of 0.1 for people inside buildings

Doses associated with such a scenario are in the order of magnitude of 0.03 μSv for one shipment, corresponding to a value of about 5 μSv/year if considering 150 shipments per year (respectively 6 μSv/year for upper annual flux of 200 casks). These values, obtained for a reference distance of 10m from shipments, might be multiplied by a factor 4 if this distance was reduced from 10m to 3m.

### Vitrified wastes – Scenario 7

During the road transportation between La Hague reprocessing plant and Valognes terminal, it is supposed that the convoys (trucks) may be stopped for an average of 2 minutes at a light. Considering an hypothetical individual standing in a building at a reference distance of 10 m from the shipment, the corresponding dose was calculated for the annual number of vitrified wastes shipments.

The dose rate was estimated on the same basis as previously described (see 0). Results are presented in table 14. Transport index of vitrified wastes shipments is supposed to range from 10 to 15.

**Table 14. Doses associated with “truck stops at road light” scenario – Vitrified wastes**

Distance from shipment	Time stop for each shipment	Dose for 1 shipment <sup>†</sup>	Total annual dose <sup>†</sup> (10 shipments)
10 m	2 minutes	0.03-0.05 μSv	0.3-0.5 μSv

<sup>†</sup> Assuming a shielding factor of 0.1 for people inside buildings

Doses associated with such a scenario are in the order of magnitude of 0.03-0.05 μSv for one shipment, corresponding to values ranging from 0.3 to 0.5 μSv/year if considering 10 shipments per year. These values, obtained for a reference distance of 10m from shipments, might be multiplied by a factor 5 if this distance was reduced from 10m to 3m.

### UO<sub>2</sub>(NO<sub>3</sub>)<sub>2</sub> LR 65 containers – Scenario 8

During the road transportation between La Hague reprocessing plant and Valognes terminal, it is supposed that the convoys (trucks) may be stopped for an average of 2 minutes at a light. Considering an hypothetical individual standing in a building at a reference distance of 10 m from the shipment, the corresponding dose was calculated for the annual number of LR 65 containers shipments, taken to be 239.

The dose rate was estimated on the same basis as previously described (see 0). Results are presented in table 15. Transport index of LR 65 containers is supposed to be 3.

**Table 15. Doses associated with “truck stops at road light” scenario – LR 65 containers**

Distance from shipment	Time stop for each shipment	Dose for 1 shipment <sup>†</sup>	Total annual dose <sup>†</sup> (239 shipments)
10 m	2 minutes	$9.5 \times 10^{-3} \mu\text{Sv}$	2.3 $\mu\text{Sv}$

<sup>†</sup> Assuming a shielding factor of 0.1 for people inside buildings

Doses associated with such a scenario are in the order of magnitude of 0.01  $\mu\text{Sv}$  for one shipment, corresponding to about 2.3  $\mu\text{Sv}/\text{year}$  if considering 239 shipments per year. These values, obtained for a reference distance of 10m from shipments, might be multiplied by a factor 5 if this distance was reduced from 10m to 3m.

### Fuel assemblies – Scenario 9

During the road transportation from FBFC Romans to reactors, it is supposed that the convoys of fuel assemblies (trucks) may be stopped for an average of 2 minutes at a light in localities in the vicinity of FBFC. Considering an hypothetical individual standing in a building at a reference distance of 10 m from the shipment, the corresponding dose was calculated for the 196 annual fuel assemblies shipments taken from [6].

The dose rate was estimated on the same basis as previously described (see 0). Results are presented in table 16. Transport index of fuel assemblies shipment (4 RCC) is taken to be 6.5 [6].

**Table 16. Doses associated with “truck stops at road light” scenario – fuel assemblies**

Distance from shipment	Time stop for each shipment	Dose for 1 shipment <sup>†</sup>	Total annual dose <sup>†</sup> (196 shipments)
10 m	2 minutes	0.02 $\mu\text{Sv}$	4 $\mu\text{Sv}$

<sup>†</sup> Assuming a shielding factor of 0.1 for people inside buildings

Doses associated with such a scenario are in the order of magnitude of 0.02  $\mu\text{Sv}$  for one shipment, corresponding to 4  $\mu\text{Sv}/\text{year}$  if considering 196 shipments per year. These values, obtained for a reference distance of 10m from shipments, might be multiplied by a factor 5 if this distance was reduced from 10m to 3m.

### Enriched UF6 – Scenario 10

During the road transportation of UF6 (enriched) to FBFC Romans, it is supposed that the shipments (trucks) may be stopped for an average of 2 minutes at a light in localities in the vicinity of FBFC. Considering an hypothetical individual standing in a building at a reference distance of 10 m from the shipment, the corresponding dose was calculated for the 95 UF6 shipments taken from [6].

The dose rate was estimated on the same basis as previously described (see 0). Results are presented in table 17. Transport index of enriched UF6 (6 x COG OP 30 B) is taken to be 1 (ranges from 0.6-0.8) [6].

**Table 17. Doses associated with “truck stops at road light” scenario – UF6**

Distance from shipment	Time stop for each shipment	Dose for 1 shipment <sup>†</sup>	Total annual dose <sup>†</sup> (95 shipments)
10 m	2 minutes	$3 \times 10^{-3} \mu\text{Sv}$	0.3 $\mu\text{Sv}$

<sup>†</sup> Assuming a shielding factor of 0.1 for people inside buildings

Doses associated with such a scenario are in the order of magnitude of  $3 \times 10^{-3} \mu\text{Sv}$  for one shipment, corresponding to  $0.3 \mu\text{Sv}/\text{year}$  if considering 95 shipments per year. These values, obtained for a reference distance of 10m from shipments, might be multiplied by a factor 5 if this distance was reduced from 10m to 3m.

### 2.3 Medical sources

#### Christ de Saclay

#### Scenario 11

All expeditions of medical sources from SCHERING CIS-BIO pass through a small low-populated locality, named “Christ de Saclay”, before reaching the closest main road (National road n°118) through a major crossroad. A hotel-restaurant is located in the vicinity of this crossroad. The dose of an hypothetical individual working in this hotel-restaurant and being exposed to all transports of the medical sources was calculated with INTERTRAN 2, assuming the vehicles transporting the sources are passing through this zone at a 10 km/h speed, at a distance of 30 m. A shielding factor of 0.1 was considered to take into account the attenuation of dose rates through building walls.

The dose rate at 1m from vehicles carrying medical sources was supposed to be 0.2 mSv/h (derived from the regulatory limit dose rate at 1m from shipment of 0.1 mSv/h). A total flux of 4 160 vehicles per year was considered. Additionally, the doses associated with 200 transports of Type-B (gammagraphs) in the same area were calculated, for a dose rate at 1m from vehicle of 0.01 mSv/h (upper value).

**Table 18. Doses associated with “Christ de Saclay” scenario – Type-A and Type-B sources**

Type of transport	Dose rate at 1m of shipment (mSv/h)	Nb transports	Dose
Medical (SCHERING CIS-BIO)	0.2	4 160 vehicles/y	0.84 $\mu\text{Sv}$
Type-B	0.01	200 vehicles/y	$2 \times 10^{-3} \mu\text{Sv}$

The total dose associated with the transport of medical sources (SCHERING CIS-BIO) is estimated to be about  $0.84 \mu\text{Sv}$  for a flux of 4 160 vehicles/y, while the one of 200/y Type-B transports are estimated to  $2 \times 10^{-3} \mu\text{Sv}$ .

#### Storage at TransRoute Santé

#### Scenario 12

Medical sources expedited by SCHERING CIS-BIO and destined to be transported in France from Paris to province converge in a locality in the South of Paris which serves as a transit platform for shipments. Over one week, about 200 packages may be stored in this platform for an average duration of 2 hours/day on Monday, Wednesday and Thursday, while about 300 others may be stored for an average duration of 5 hours/day on Tuesday and Friday. About 60% of these packages are of Type-A while remaining 40% are excepted packages. For simplification purposes, it was assumed for calculations that 50% of Type-A packages have a TI of 0.2 and 50% have a TI of 2 (maximum value).

Assuming that an hypothetical individual may be standing close to the stored packages at a minimum distance of 50 m for the whole storage duration, the dose resulting from the ambient dose rates was calculated. The 200-300 stored packages were treated as a stock-pile of a spherical volume of 1 m characteristic radius (given the 30 cm x 30 cm x 30 cm dimensions of such packages). Resulting dose rate at a distance of 50 m was calculated by assuming the stock-pile as a point source, according to the formulae given in 0 (see Annex for more calculation details). An additional shielding factor of 0.1 was considered to



take into account the attenuation of building walls. The contribution of excepted packages (Type-E) was not taken into account.

**Table 19. Doses associated with “storage at TransRoute Santé” scenario – medical Type-A packages**

Type of exposure	Duration of exposure	Dose rate at 50 m <sup>†</sup>	Dose <sup>‡</sup>
200 packages stock-pile	2 hour per day, 3 days per week, 47 weeks per year	2 µSv/h	60 µSv
300 packages stock-pile	5 hours per day, 2 days per week, 47 weeks per year	3 µSv/h	140 µSv
<b>Total</b>			<b>200 mSv</b>

<sup>†</sup> Assuming 60% of packages of Type-A with TI of 0.2 (50% Type-A) and 2 (50% Type-A)

<sup>‡</sup> Assuming a shielding factor of 0.1 for people inside buildings

The total dose associated with the exposure to temporary stored packages at TransRoute Santé is in the order of magnitude of 200 µSv if the exposed individual stays 100% of storage time at the distance of 50m from packages. Considering that the exposure time could be only 60% of total storage time, the dose would be about 120 µSv.

#### 2.4 Radioactive wastes (nuclear fuel cycle and civil research and industry)

##### Exposure during road stops

### Scenario 13

During the road transportation of radioactive wastes to the storage centre located in the department of Aube (CSA), it is supposed that the convoys (trucks) may be stopped for an average of 2 minutes at a light in one of the small localities in the vicinity of the CSA. Considering an hypothetical individual standing in a building at a reference distance of 10 m from the shipment, the corresponding dose was calculated for an annual number of wastes shipments estimated to 1 355 vehicles per year (number of vehicles arrived at the CSA in the year 2000 according to IRSN database).

All radioactive wastes are supposed to be transported into containers of 20 ft each. Two containers are transported on each shipment. The dose rate at 1m from shipment was taken to 0.2 mSv/h, value derived from the regulatory limit dose rate at 2m (0.1 mSv/h).

The dose rate was estimated on the same basis as previously described (see 0). Results are presented in table 20.

**Table 20. Doses associated with “truck stops at road light” scenario – Wastes**

<b>Distance from shipment</b>	<b>Time stop for each shipment</b>	<b>Dose for 1 shipment<sup>†</sup></b>	<b>Total annual dose<sup>†</sup> (1 355 shipments)</b>
10 m	2 minutes	0.01-0.05 $\mu\text{Sv}$	13.5-67 $\mu\text{Sv}$

<sup>†</sup> Assuming a shielding factor of 0.1 for people inside buildings

Doses associated with such a scenario are in the order of magnitude of 0.01-0.05  $\mu\text{Sv}$  for one shipment, corresponding to values ranging from 13 to 70  $\mu\text{Sv}/\text{year}$  if considering 1 355 shipments per year. These values, obtained for a reference distance of 10m from shipments, might be multiplied by a factor 8 if this distance was reduced from 10m to 3m.

#### *2.5 Synthesis of individual doses estimated for public*

Table 21 summarises the individual doses estimated for the public, associated with the transport of radioactive materials in France for different hypothetical exposure scenarios. These scenarios refer to hypothetical individuals who may be exposed in normal conditions of transport. The assumptions made can be conservative in some cases, but this should be confirmed by an in-deeper study on more realistic critical groups.

Most penalising scenarios are associated with Type-A medical sources (Scenario 12), spent fuel (Scenario 4) and radioactive wastes from nuclear fuel cycle and civil research and industry (Scenario 13), leading to estimated individual exposures of a hundred of  $\mu\text{Sv}$ .

**Table 21.** Summary of individual doses for public – *Hypothetical scenarios of exposure associated with the transport of radioactive materials in France*

Related industry	Scenario	Individual dose
Nuclear fuel cycle	Scenario 1: spent fuel; exposure along railways	0.8 $\mu\text{Sv/y}$ (150 shipments)
	Scenario 2: vitrified wastes; exposure along railways	0.05-0.08 $\mu\text{Sv/y}$ (10 shipments)
	Scenario 3: Uranium oxide LR 65 containers; exposure along railways	0.4 $\mu\text{Sv/y}$ (239 shipments)
	Scenario 4: spent fuel; train stops near buildings	20-150 $\mu\text{Sv/y}$ (150 shipments)
	Scenario 5: spent fuel; train stops under bridge	5 $\mu\text{Sv}$ (single shipment)
	Scenario 6: spent fuel; truck stops at road light	5 $\mu\text{Sv/y}$ (150 shipments)
	Scenario 7: vitrified wastes; truck stops at road light	0.3-0.5 $\mu\text{Sv/y}$ (10 shipments)
	Scenario 8: Uranium oxide LR 65 containers; truck stops at road light	2.3 $\mu\text{Sv/y}$ (239 shipments)
	Scenario 9: fuel assemblies, truck stops at road light	4 $\mu\text{Sv/y}$ (196 shipments)
	Scenario 10: UF <sub>6</sub> , truck stops at road light	0.3 $\mu\text{Sv/y}$ (95 shipments)
Medical sources	Scenario 11: SCHERING CIS-BIO transports through “Christ de Saclay”	0.84 $\mu\text{Sv/y}$ (4 160 Type-A vehicles) 0.002 $\mu\text{Sv/y}$ (200 Type-B vehicles)
	Scenario 12: Storage at TransRoute Santé	120 $\mu\text{Sv/y}$ (SCHERING CIS-BIO Type-A packages)
Radioactive wastes (nuclear fuel cycle and civil research and industry)	Scenario 13: truck stops at road light	13-67 $\mu\text{Sv/y}$ (1 355 shipments delivered to CSA)



### 3. CONCLUSION

This study presents results on estimates of collective doses to the public associated with the transport of radioactive materials in France for the year 1997. It has been performed on the basis of previous studies and complementary data provided by IRSN.

Collective doses related to the transport of medical sources represent the highest contribution (>52%) to the total public exposure, ranging from 1 300 to 3 168 man.mSv over a total of 2 515-5 195 man.mSv. Public exposures associated with the transport being a matter of the nuclear fuel cycle are far lower, i.e. a few hundreds of man.mSv/year. These results can be put into perspective with the total collective dose associated with the whole nuclear fuel cycle in France calculated in [1], which estimates to about 5 thousands man.Sv the collective dose for the public, for an annual nuclear electricity generation of 376 TWh.

The maximum individual doses associated with hypothetical scenarios for the different types of transports considered are estimated to be about 100-150  $\mu$ Sv/y. They correspond to the flows of spent fuel, radioactive wastes converging to the storage centre of Aube (CSA) and to the temporary storage of medical sources from SCHERING CIS-BIO at TransRoute Santé.

It must be noted that these results are based on rough assumptions in normal conditions of transport, and should be confirmed by an in-deeper evaluation of individual exposures of more realistic critical groups.

**APPENDIX 1**  
**METHODOLOGY FOR CALCULATING DOSE RATES AT GIVEN DISTANCES FROM**  
**PACKAGES STOCK-PILES AT TRANSROUTE SANTE**

For the storage of Type-A packages at TransRoute Santé, it was assumed that all packages were stored in a single cubic pile. Given the average volume of one package (30 x 30 x 30 cm), the total volume of 200 and 300 package stock-pile is approximately 5.4 and 8.1 m<sup>3</sup> respectively. This was modelled as a spherical volume of about 1m radius.

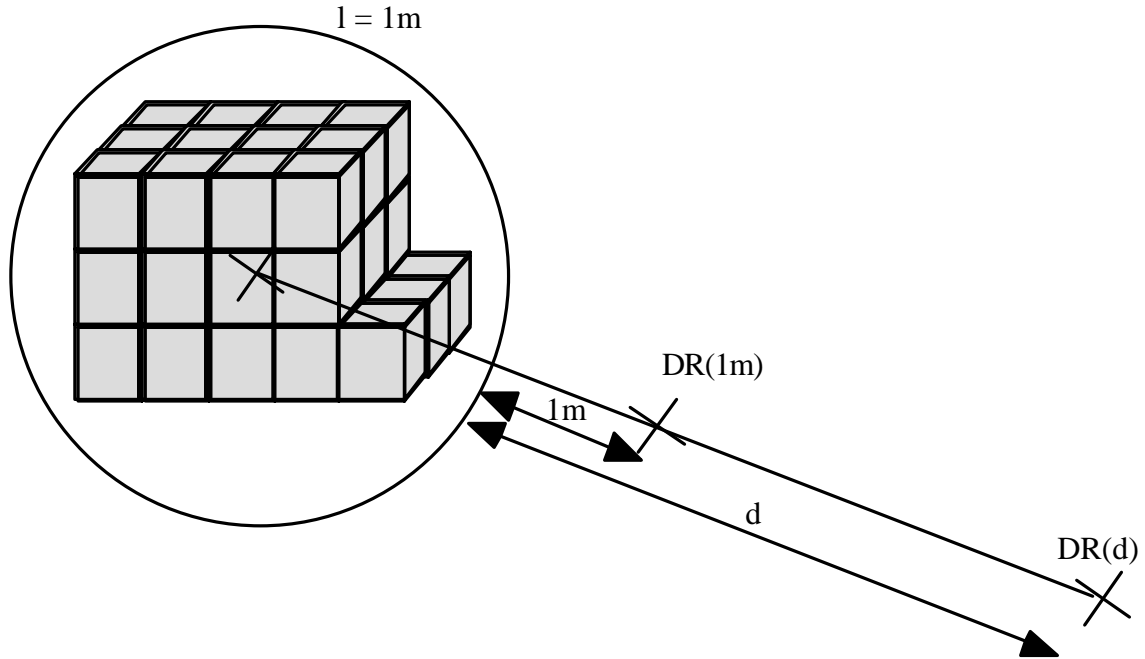

Dose rate (DR) at given distances (d) from this stock-pile was calculated by the following formulae, assuming that the pile characteristic dimension (l=1m) can be considered as a point source for such values of d.

$$DR(d) = DR(1m) \cdot \frac{\left(1 + \frac{\lambda}{2}\right)^2}{\left(d + \frac{\lambda}{2}\right)^2} \text{ with distances in meters.}$$

DR(1m) corresponds to the dose rate at a distance of 1m from one package. In a first rough assumption, the dose rate associated with N packages is supposed to be N-fold the dose rate associated with one single package (conservative approach, considering no shielding effects of the pile).

For a 200 package stock-pile, 120 packages are of Type-A (60%). 50% of these Type-A packages – i.e 60 packages – have a DR(1m) = 0.002 mSv/h and the remaining 50% have a DR(1m) = 0.02 mSv/h.

Thus the stock-pile DR(1m) = (0.002 x 60) + (0.02 x 60) = 1.32 mSv/h.

Dose rate at 50m from the 200 package stock-pile can be calculated:  
 DR200(50m) ~ 2 µSv/h.

On the same basis, dose rate at 50m from the 300 package stock-pile can be calculated:  
 DR300(50m) ~ 3 µSv/h.

## REFERENCES

- [<sup>1</sup>] DREICER M., TORT V., MARGERIE H., **The external costs of the nuclear fuel cycle: Implementation in France**, CEPN Report No.238, 1995.
- [<sup>2</sup>] DREICER M., TORT V., MANEN P., **Nuclear fuel cycle: estimation of physical impacts and monetary valuation for priority pathways**, CEPN Report No.234, 1995.
- [3] TORT V., RANCILLAC F., SCHNEIDER T., **Analyse du transport des déchets de faible et moyenne activités vers le centre de stockage de l'Aube**, Rapport CEPN No.206, 1992.
- [4] TABARE M., RANCILLAC F., **Bilan des flux de transport de matières radioactives portées à la connaissance de l'IRSN, année 1997**, Rapport DSMR/2000-004 Rév.0, 2000.
- [<sup>5</sup>] RAFFESTIN D., SCHNEIDER T., **Assessment of the radiological risks of road transport accidents involving type-A packages**, 1997.
- [6] LIZOT M.T., **Survey of operational data for transport – CRP contamination**, IRSN/DSMR/SSTR draft report SSTR/02-376, 2002.
- [<sup>7</sup>] AMC Konsult AB, **INTERTRAN 2**, Transportation Risk Assessment Package.
- [8] HUBERT P., PAGES P., **L'évaluation de la sûreté des transports de matières radioactives : cas d'un petit colis de type B**, Rapport CEPN No.36, 1981.
- [9] HUBERT P., PAGES P., **L'évaluation de la sûreté des transports de matières radioactives : le cas des petits colis de type A**, Rapport CEPN No.42, 1982.
- [10] HUBERT P., PAGES P., **Fixation d'une limite d'activité pour le transit des produits pharmaceutiques à travers le tunnel du Mont-Blanc : éléments d'appréciation**, Rapport CEPN No.90, 1985.
- [<sup>11</sup>] JUANOLA M., **Evaluation de la dosimétrie associée au transport de combustibles irradiés à l'aide d'INTERTRAN 2**, Note Technique SEGR/SAER/99-106, 1999.