

# Proton therapy – Specific radiation protection issues



THE HENRYK NIEWODNICZAŃSKI  
INSTITUTE OF NUCLEAR PHYSICS  
POLISH ACADEMY OF SCIENCES

Agnieszka Szumska



*EU Scientific Seminar 2023: Radiation protection issues in modern external beam radiotherapy*

*Luxembourg, 21 November 2023*

# Overview

---

- Introduction
  - Radiotherapy
  - Proton therapy
- Radiation Protection
  - Patient
  - Personnel
  - Public
- Summary



# Radiotherapy

- One of the main treatment modalities for cancer (often in combination with chemotherapy and surgery)
- Increased tumor control probability increases the risk of intolerable complications
- The challenge is maximizing tumor damage while sparing healthy tissues to minimize complications and secondary cancer risk

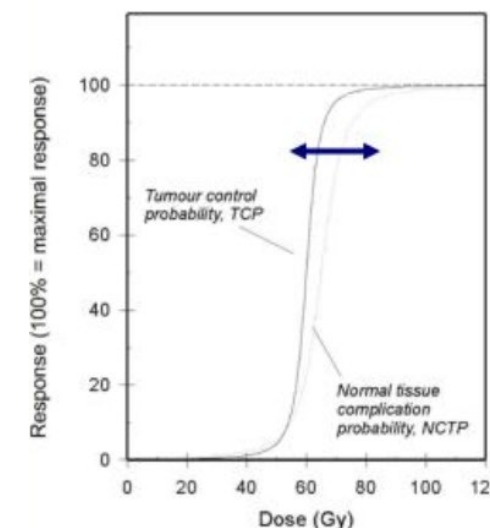
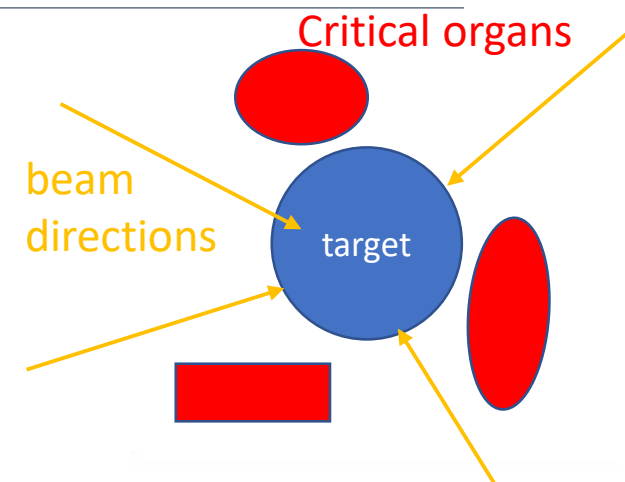

# Proton therapy

- 1946: R. Wilson first proposed a possible therapeutic application of proton and ion beams



## Radiological Use of Fast Protons

ROBERT R. WILSON  
 Research Laboratory of Physics, Harvard University  
 Cambridge, Massachusetts

EXCEPT FOR electrons, the particles which have been accelerated to high energies by machines such as cyclotrons or Van de Graaff generators have not been directly used therapeutically. Rather, the neutrons, gamma rays, or artificial radioactivities produced in various reactions of the primary particles have been applied to medical problems. This has, in large part, been due to the very short penetration in tissue of neutrons, deuterons, per centimeter of path, or specific ionization, and this varies almost inversely with the energy of the proton. Thus the specific ionization or dose is many times less where the proton enters the tissue at high energy than it is in the last centimeter of the path where the ion is brought to rest. These properties make it possible to irradiate intensely a strictly localized region within the body, with but little skin dose. It will be easy to produce well

- 1954: first patient treated with deuteron and helium beams at Lawrence Berkeley Laboratory (LBL)
- 1957: first patient treated in Europe: The Gustav Werner Institute in Uppsala, Sweden

# Proton therapy worldwide

Over one hundred proton facilities are in operation and over fifty are at different stages of development

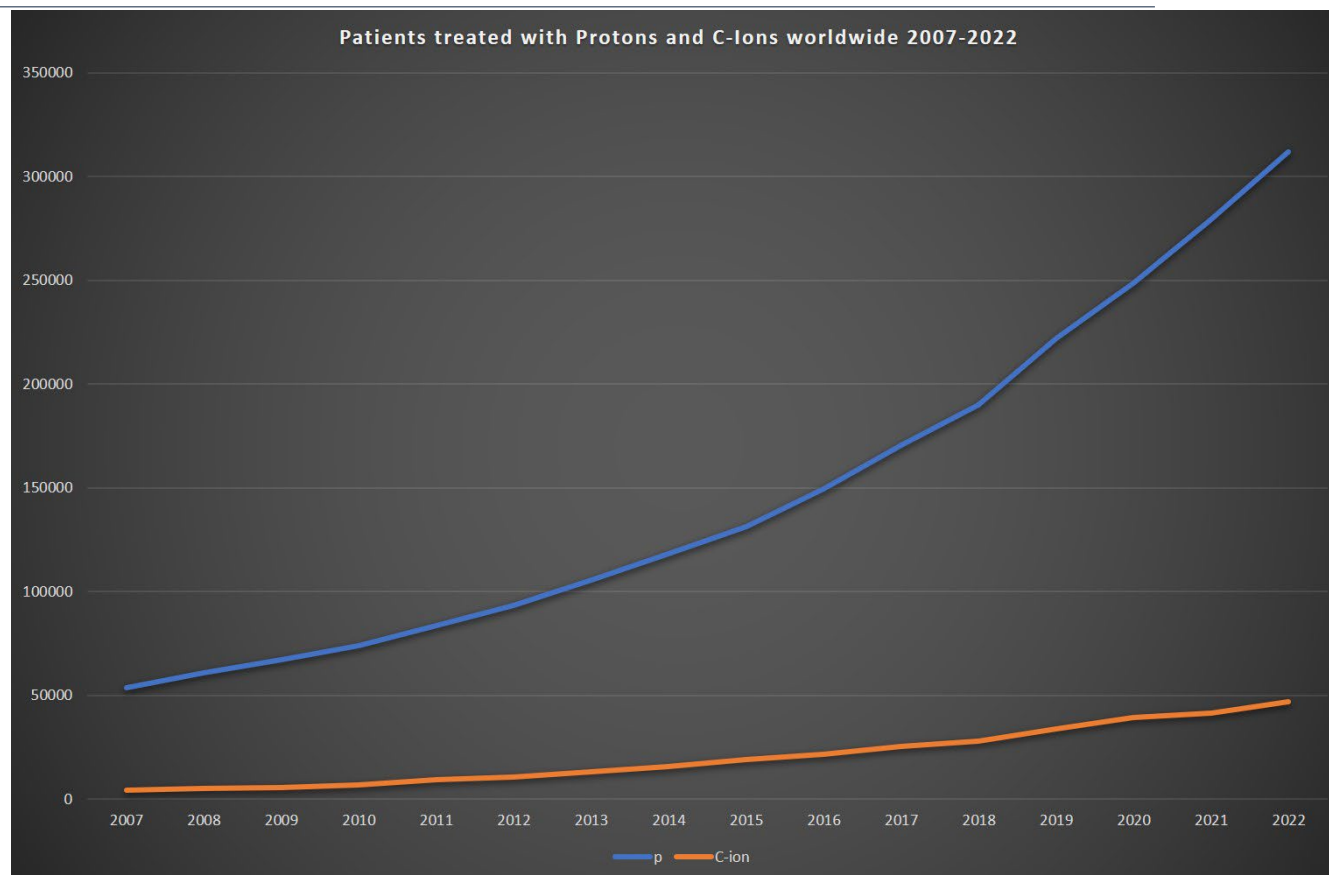

*Patient treated with Protons and C-ions worldwide  
[PTCOG, available from <https://ptcog.site/index.php/patient-statistics-2>]*

# Proton therapy

- Proton interactions with matter:
  - Maximal energy losses at the end of hadron range (Bragg peak)
  - Particle range changing with energy
    - $^1\text{H}$ : 70 MeV to 230 MeV (32 cm in water)
  - Highly ionizing particles.
- Advantages wrt classical radiotherapy:
  - Precise control of the dose delivered to the tumor
  - Reduction of dose delivered to healthy tissue, sparing critical organs located behind tumor.
  - Higher radiobiological efficiency (RBE  $\sim$  1.1).

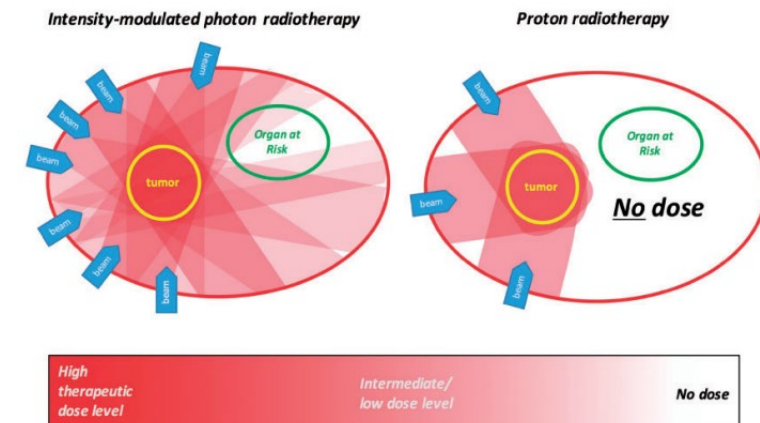
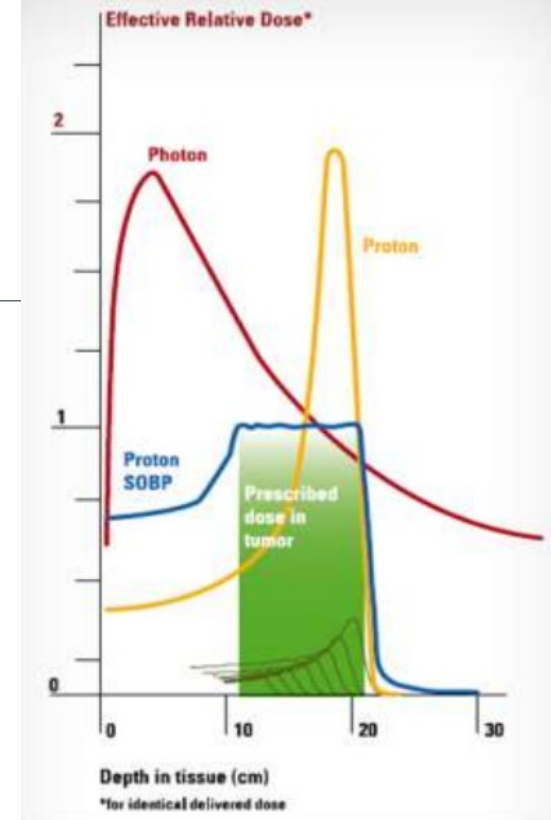

Proton therapy technology evolution in the clinic: impact on radiation protection T. Depuydt



# Main hazards in proton therapy

## Primary Beam

Protons

cyclotron vault, beamline and treatment rooms

high dose (0.5 Gy to 20 Gy)

## Prompt Secondary Radiation

Neutrons, gammas, and many others

cyclotron vault, beamline and treatment rooms

medium dose (typically 1-10% of primary beam depending on biological effect)

## Residual Secondary Radiation

Gammas

cyclotron vault, beamline and treatment rooms

low dose (depends on materials and time since irradiation)

# Main hazards in proton therapy

## Primary Beam

Protons

In fact, less than 20% of the initially produced ions are used for treatment.  
 The remaining 80% of the ions produced are lost in the treatment beam production process and pose some radiation protection issues.

high dose (typically 20 Gy)

## Prompt Secondary Radiation

medium dose (typically 1-10% of primary beam depending biological effect)

## Residual Secondary Radiation

low dose (depends on materials and time since irradiation)

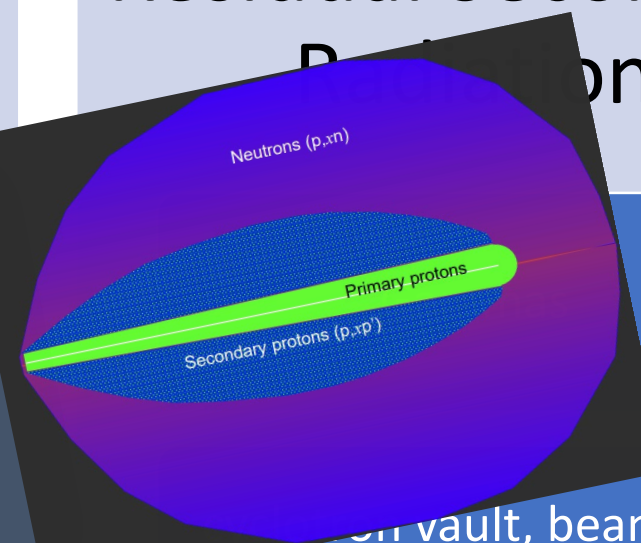



# Nuclear reactions: Neutron & Photon production

- Production rates for neutrons ( $n/p$ ) and photons ( $\gamma/p$ ) strongly vary with target type and beam energy.
- Neutron production yields strongly increase with  $A=Z+N$  of material
- Neutrons and photons are produced at various locations along the beam path when protons hit matter

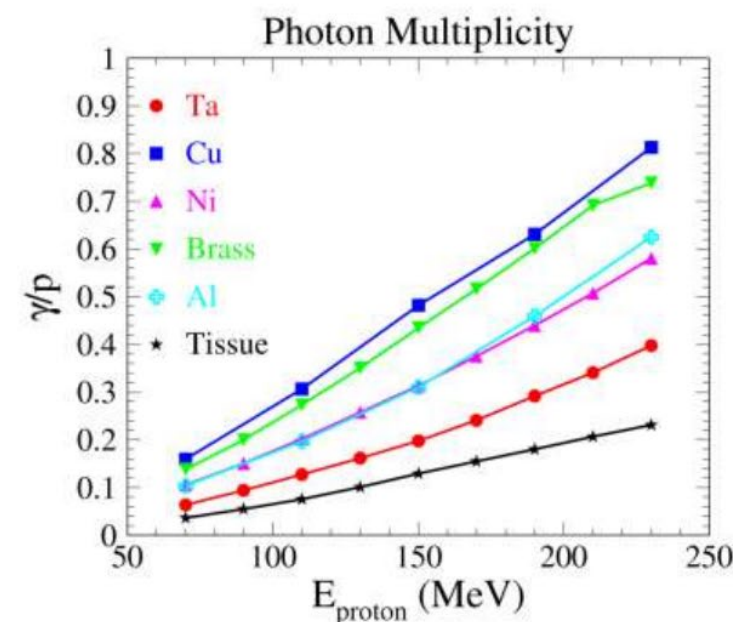
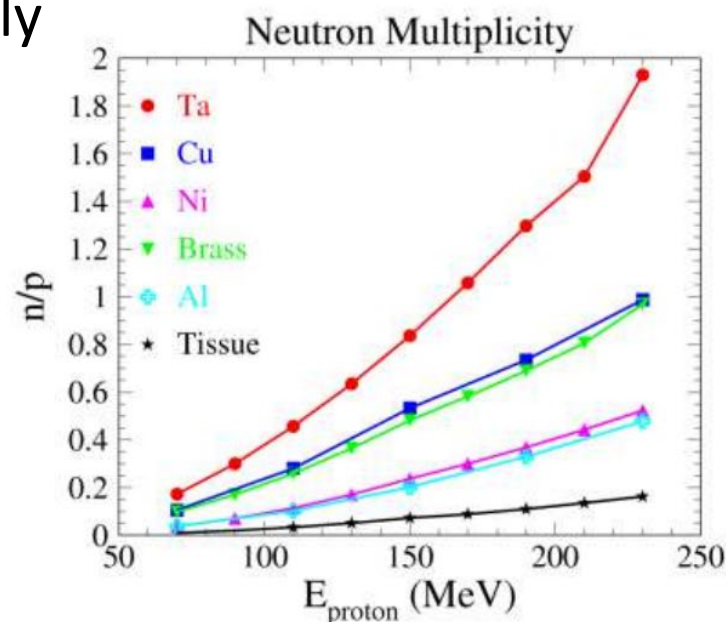

*The average number of secondary neutrons and photons produced by the interaction of one proton with different targets depends on the proton energy*

# Who needs protection at a medical facility?

---

- The Patient
- The Staff
- The Public

# Patient exposure

---

- Imaging procedures are essential in treatment planning, similar to other modern radiotherapies, and deliver an additional dose of radiation to the patient.

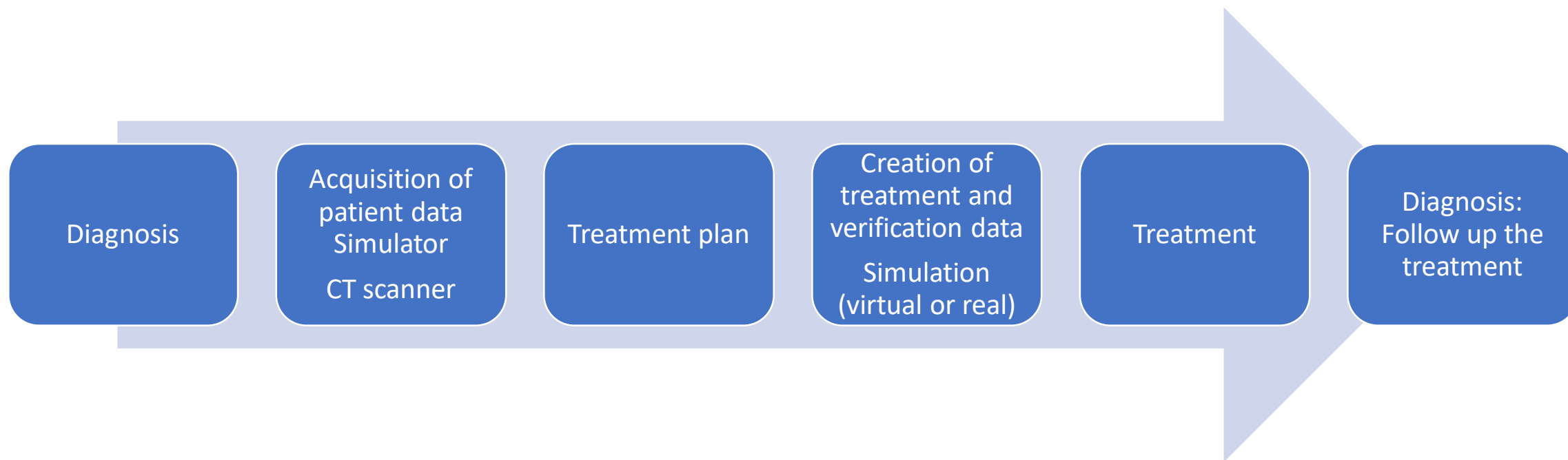

# Out-of-field doses

- For all organs, Pencil Beam Scanning (PBS) radiotherapy shows much lower mean organ doses per target dose ( $mGy/Gy$ ) compared to photon techniques.
- For brain irradiations of children doses in lungs and breasts are lower by factor 2-3, and up to three orders of magnitude for stomach and gall bladder.

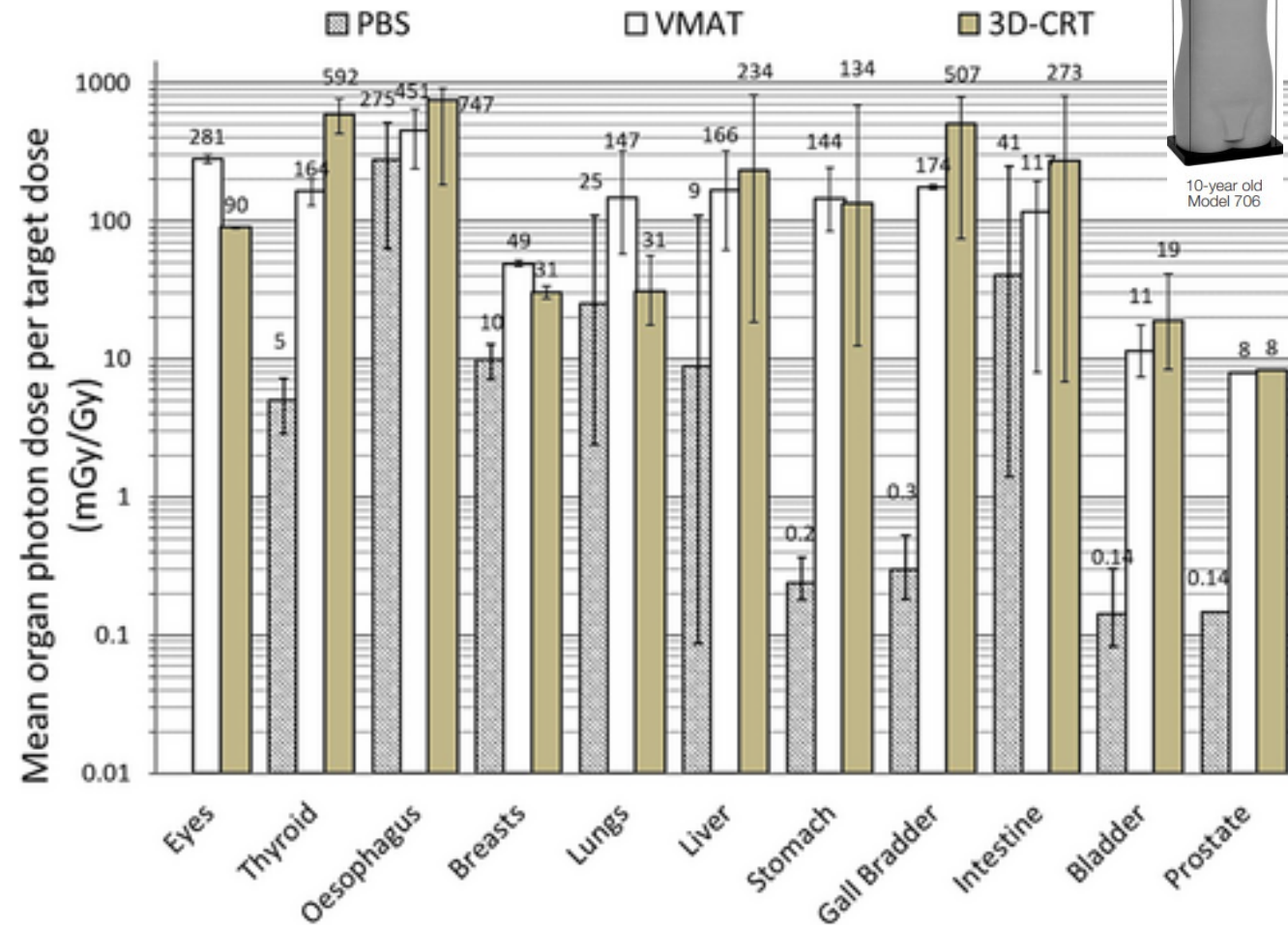

10-year old Model 706

# Secondary radiation produced in the patient

- Secondary radiation is also produced in the patient's body
- Ideally, the scanning method does not require scattering devices in the treatment head or patient apertures and compensators.
- As a result, overall secondary neutron production in the treatment head is reduced and the majority of the secondary neutrons are now generated in the patient's body.
- For these reasons, the proton beam scanning technique yields the lowest scattered dose when compared with conventional MV X-ray radiation therapy

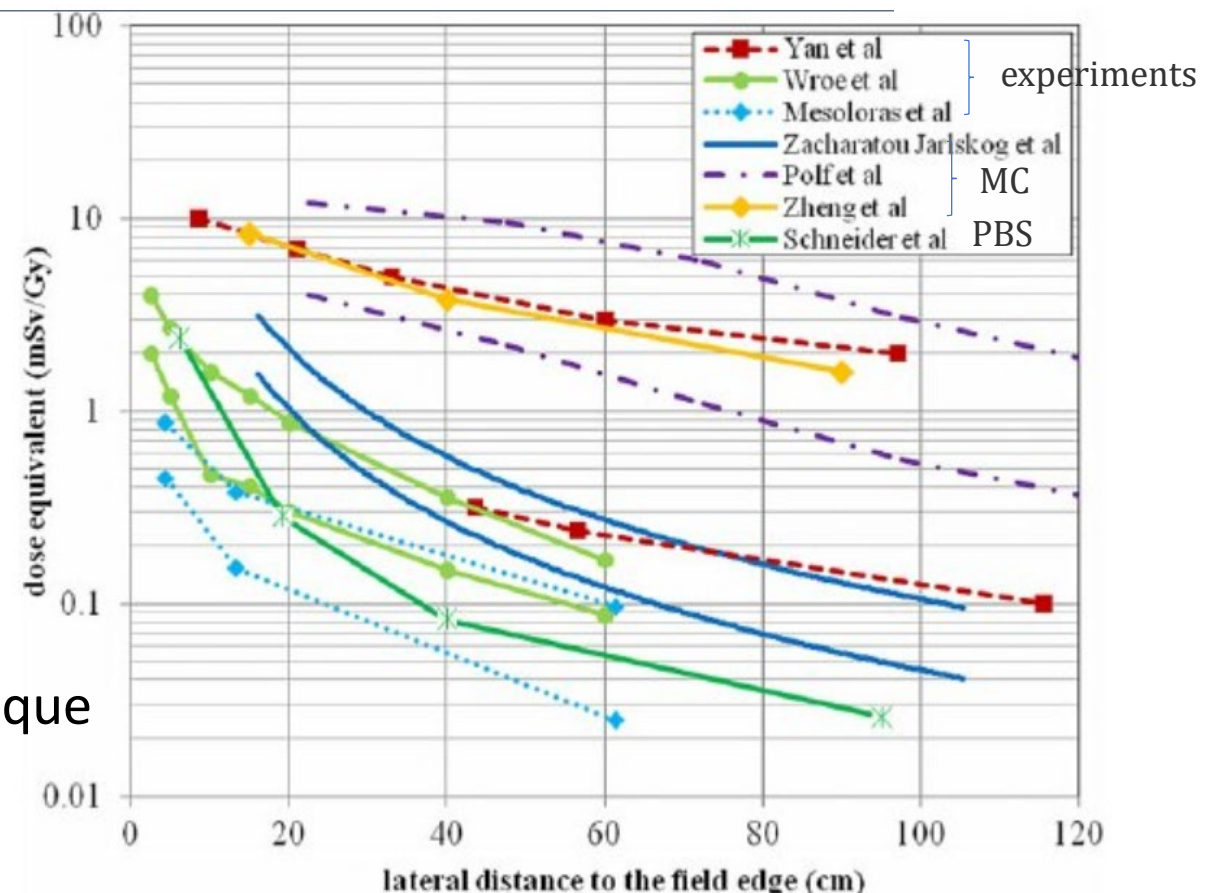

Neutron dose equivalent as a function of distance to the field edge.

*A review of dosimetry studies on external-beam radiation treatment with respect to second cancer induction X George Xu, Bryan Bednarz, and Harald Paganetti. Phys Med Biol. 2008 July 7; 53(13): R193–R241. doi:10.1088/0031-9155/53/13/R01.*

# Activation of the patient tissue

- Nuclear reactions of proton beam with tissue leads to the production of radioisotopes (activation)
- Most radioactive nuclides produced by ion beam radiotherapy have short physical half-lives in orders of minutes.
- The main radionuclide is O-15, and its dose contribution accounts for 85% of all the patient's radionuclides.
- Total activity  $\beta^+$  emitters  $\sim 10 - 25$  MBq

isotope	T <sub>1/2</sub> [min]
C-11	20.36
N-13	9.97
O-15	2.03

*Syed M. Qaim Workshop on Nuclear Data for Science and Technology 2007*





# Can parents remain near their children after the treatment?

---

- The patient leaves the treatment room 2 minutes after the end of irradiation
- A member of his/her family attends him/her for 2 hours.
- The ion beam radiotherapy for a patient would be carried out for 30 fractions of irradiation.
- The family member's exposure was calculated to be approximately 130  $\mu\text{Gy}$  in the case of proton treatment of 30 fractions.
- Tsujii et al. (2009) concluded that the exposure of a patient's family member is substantially lower than 1 mSv/year.

*Tsujii, H., Akagi, T., Akahane, K., et al., 2009. Research on radiation protection in the application of new technologies for proton and heavy ion radiotherapy. Jpn. J. Med. Phys. 28, 172–206.*





# Occupational exposure

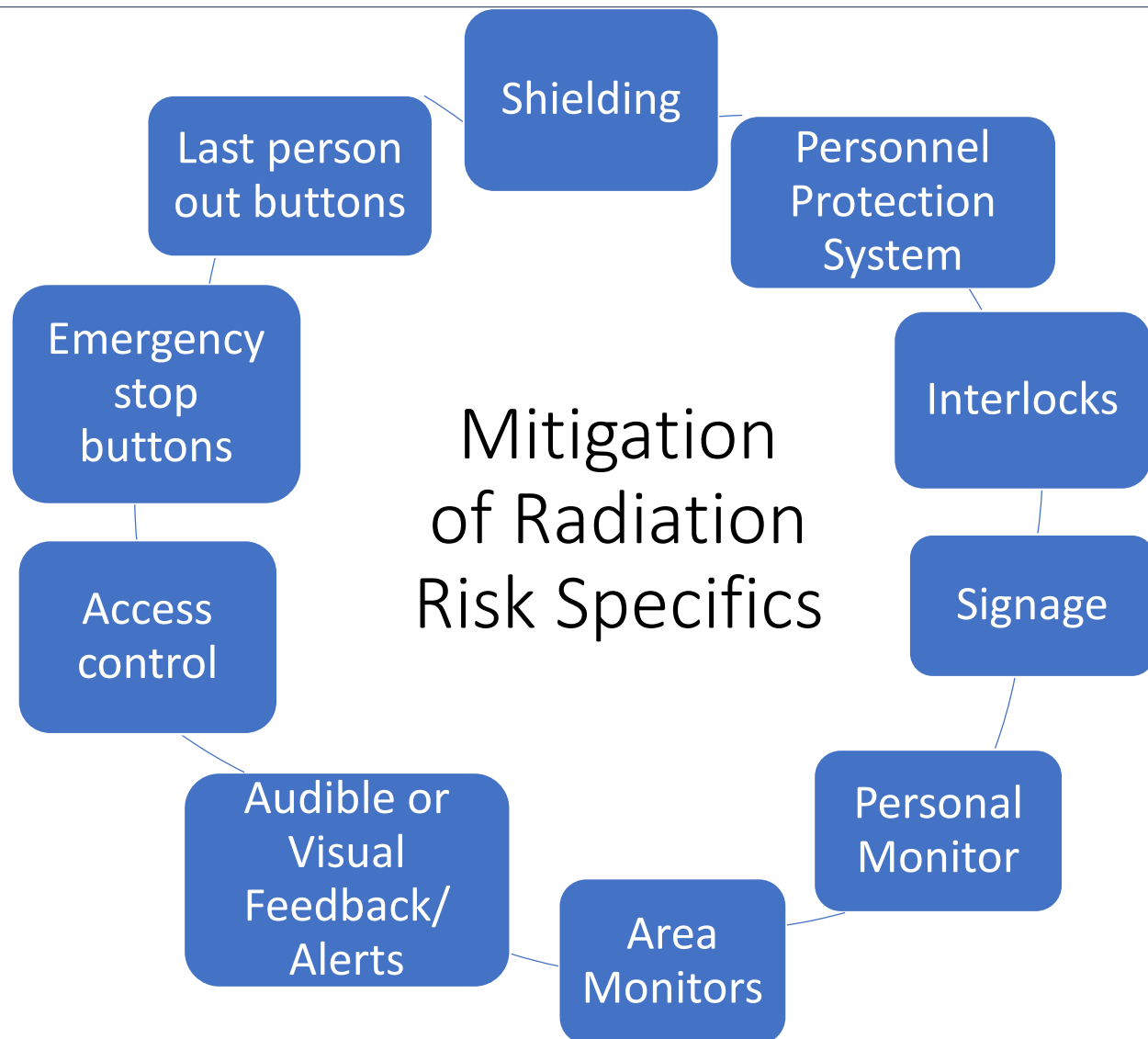

In addition to structural shielding, safe facility operation requires the introduction of several safeguard systems, devices and routines to prevent unintentional exposure or unauthorized access to radiation sources.



# Cyclotron Center Bronowice at IFJ PAN Krakow

- 2011: First eye patient treated at Institute of Nuclear Physics (IFJ PAN), Krakow with 60 MeV proton beam from AIC-144 cyclotron developed at our institute (128 patients)
- The new facility at IFJ PAN Cyclotron Center Bronowice with IBA C-230 cyclotron (230 MeV) started in February 2016: **1216** patients (992 gantry, 224 eye)

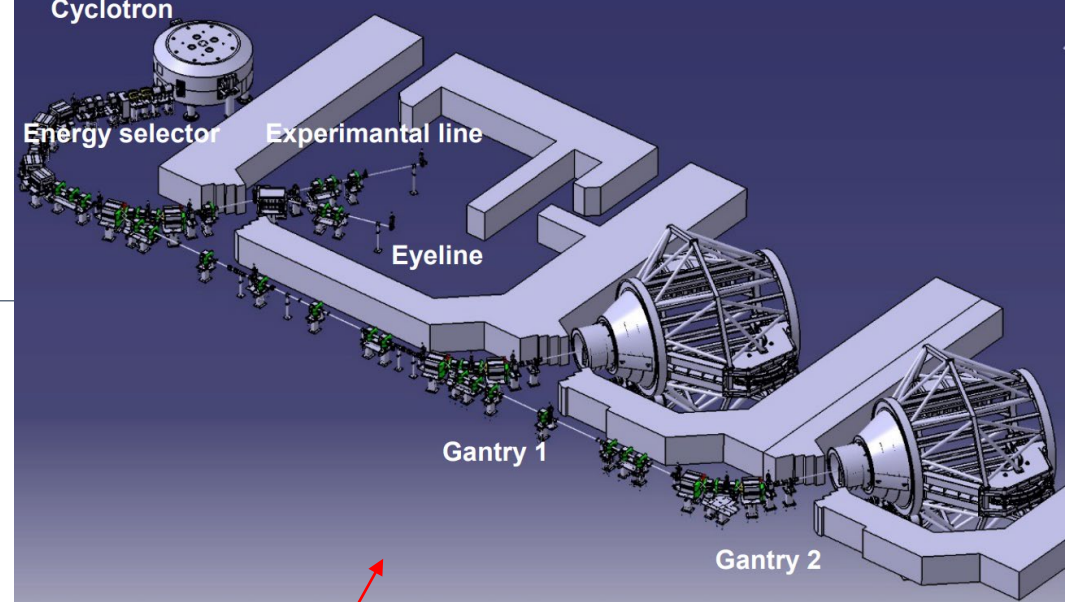

## Proteus 235 Specification

- Weight: 220 ton
- Height: 201cm Diameter: 434cm
- Energy: 230MeV
- Max. Current nA
- Radio Frequency: 106 MHz



# Types of monitoring

• Area monitoring



Passive

• Survey meters



• Personal dosimeters



Active

• Contamination monitoring



Have to be aware of:

- An Adequate calibration
- A response in strong-pulse field
- An energy dependence



# Area monitoring in CCB

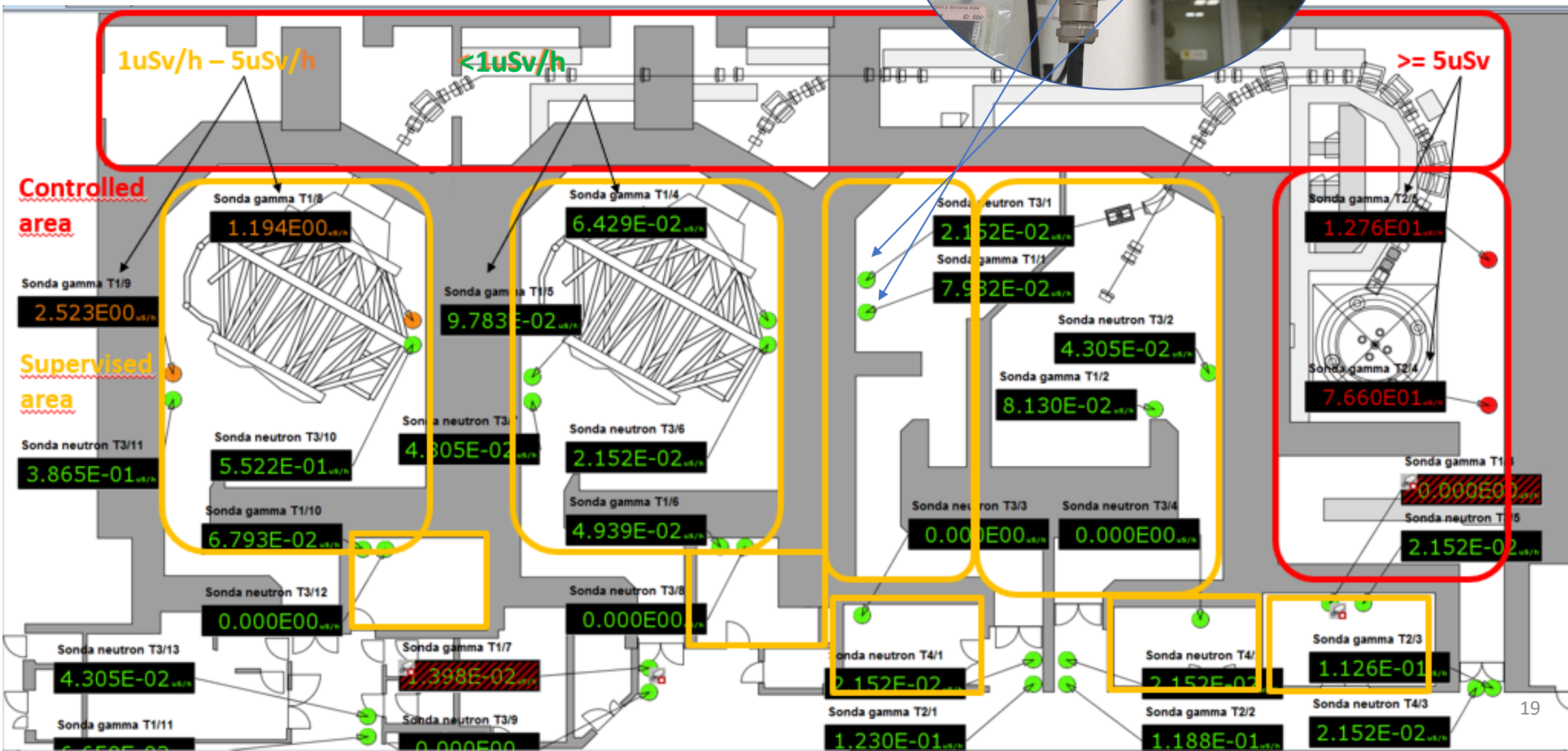
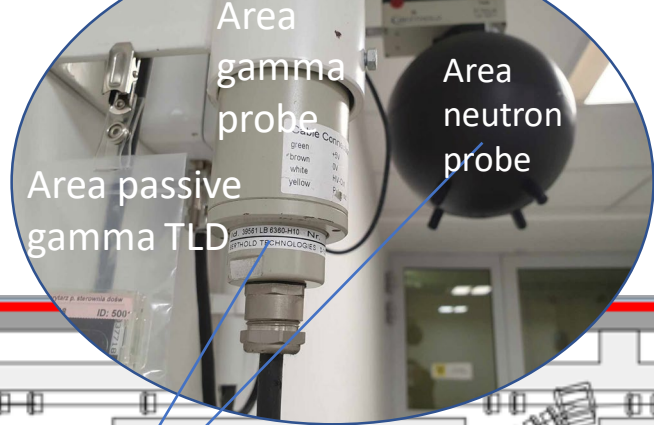



# Activation - masks

- The radiation therapy technologists (RTT) immediately after the end of irradiation take the mask off
- A RTT operates by the mask less than 30 s.
- Daily it is repeated for 10 patients, 5 days in week, 50 weeks in year.
- The maximum dose rate measured was 40  $\mu\text{Sv/h}$

$$\text{Skin doses} = 30 / 3600 \text{h} * 40 \mu\text{Sv/h} * 10 * 5 * 50 = 0.83 \text{ mSv/y}$$

- The exposure of RTT for the skin of the hands is substantially lower than 1 mSv/year.

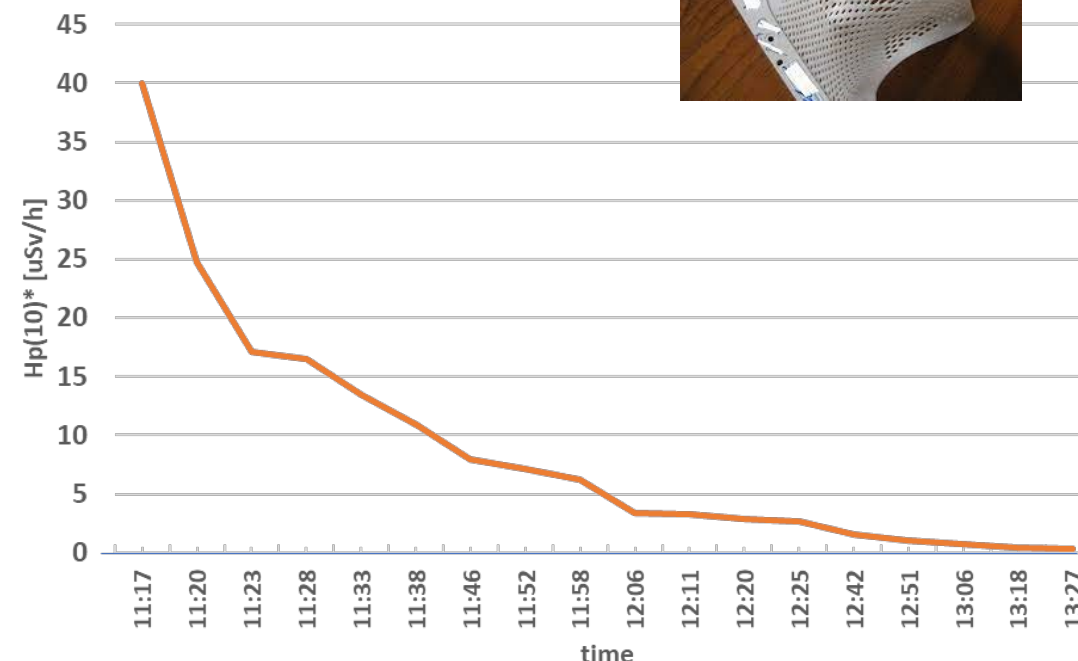

Ambient dose rate measured on the mask's surface

# Activation in the treatment rooms

## gantry

- The measured gamma dose rate in the gantry treatment room 30 min after the irradiation was on the level of natural background radiation



S.Gugula, PhD thesis, *Promieniotwórczość gamma wzbudzona w środowisku cyklotronu Proteus C-235*

## Eye treatment room

- The measured gamma dose rate in the eye treatment room 10 min after the irradiation was 256 nSv/h (2.5 times more than the natural background radiation)
- Six hours after the irradiation the dose level in the eye treatment room decreased to the natural background radiation

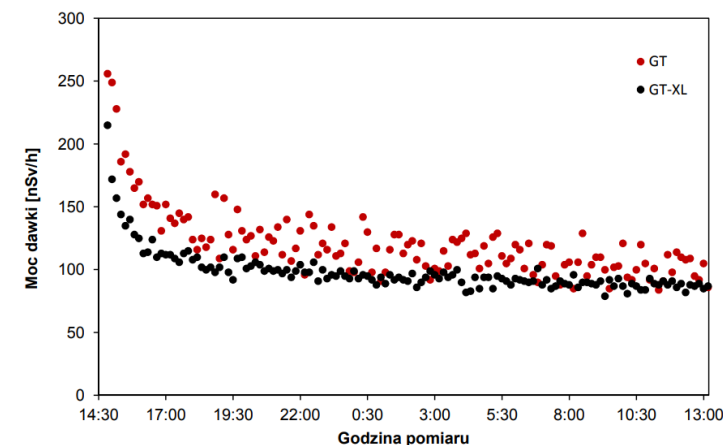

*Time dependence of gamma radiation dose rate in the eye treatment room*

# Air and water activation

## Air

- Nitrogen 78% of air
  - N-14(n,p)C-14 (78% of air)
  - C-14: 5,730 year half-life, soft  $\beta$  – Limited radiological consequence
- Oxygen 21% of air
  - O-16(n,p)N-16 (21% of air, 10 MeV threshold)
  - N-16: 7s half life, 6 MeV  $\gamma$  – limited radiological consequence
- Argon ~ 1% of air
  - Ar-40(n, $\gamma$ )Ar-41 (0.93% of air)
  - **Ar-41**: 1.8h half life, hard  $\beta$ , 1.3 MeV  $\gamma$  – **dominant hazard**



## Water

- Considering the self-shielding factors of water, and that the dose rate from activation processes is comparatively lower than that in metallic components, they are almost **negligible**.
- If water activity measurements conclude that the activity levels are below the clearance limits water is pumped to general sewage



# Activation of cyclotron and beam delivery system - exposure during the repair and maintenance

- Not possible to wait for cooling down during the malfunction - the patients should be irradiated according to the treatment plan and fractionation.

Sun	Mon	Tue	Wed	Thu	Fri	Sat
	30	31	1	2	3	4
5	6	7	8	9	10	11
12	13	14	15	16	17	18
19	20	21	22	23	24	25
26	27	28	29	30	1	

- **Maintenance** and **servicing** of the accelerator system inevitably include work close to or in direct contact with the activated system components.

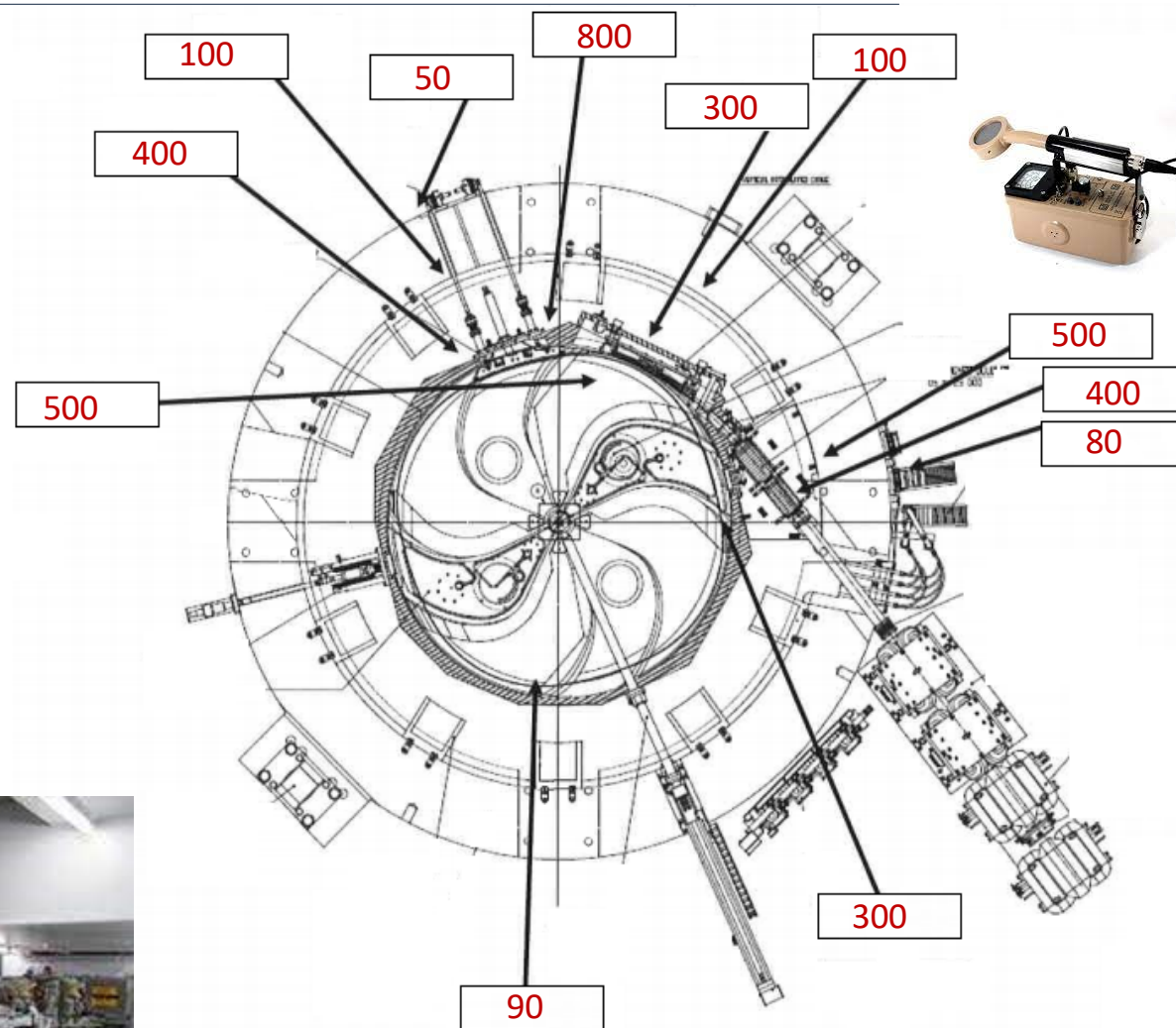

Ambient dose rate [ $\mu\text{Sv/h}$ ] measured in open cyclotron at a 10 cm distance from the surface.



# Work organisation in still 'hot' cyclotron

- Measurement of the dose rate in several places in the cyclotron
- Calculations of the working time for workers
- Checking the dose recorded by the active personal dosimeter – the alarm set on 1 mSv
- Immediately after work finishing the passive personal dosimeter is reading by the laboratory - if there was the possibility of obtaining significant doses

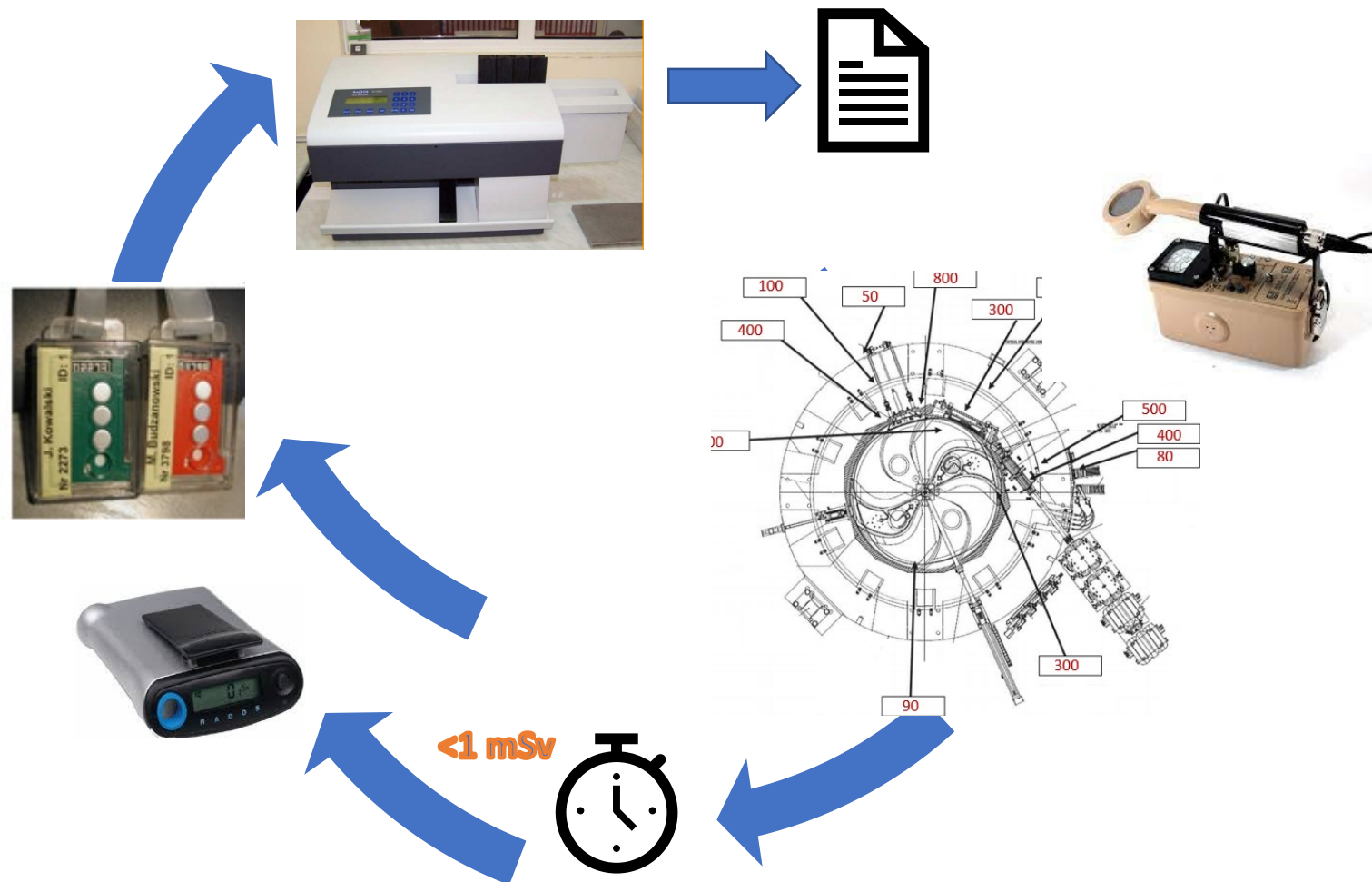



# Occupational doses at CCB

## Cyclotron service

- The main doses are obtained during the maintenance procedure:
  - Up to 0.5 mSv per maintenance in normal operations
  - Up to 2.5 mSv per maintenance in unexpected damages
- During the routine work/operation the measured doses are below the threshold dose (0.1mSv/quarter).



Physicists and radiation therapy technologists



# Radioactive waste management

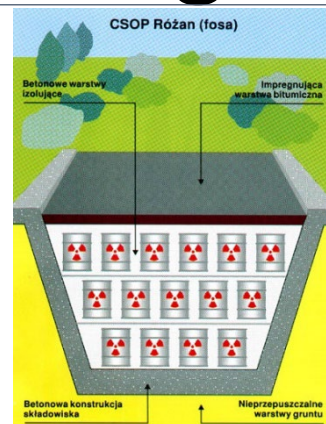

authorized area for radioactive waste disposal

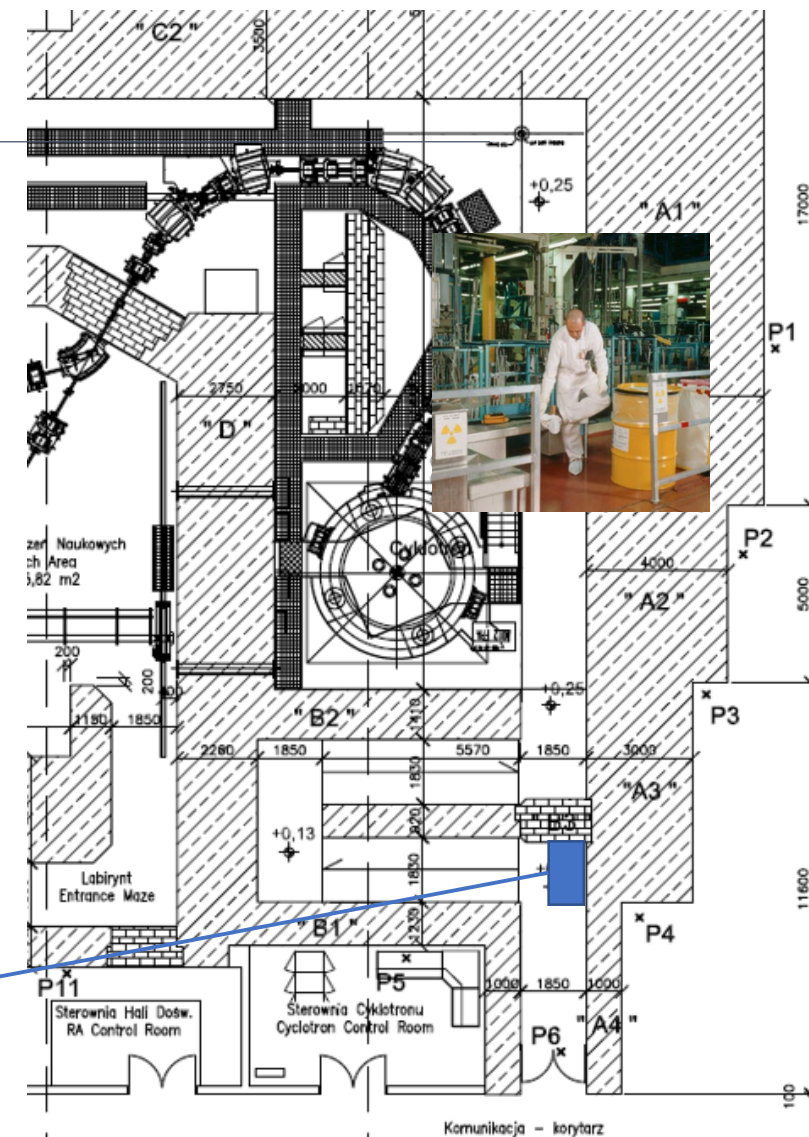

temporary radioactive material storage

radioactive material storage



# Radioactive waste management – not enough activated or too much activated?

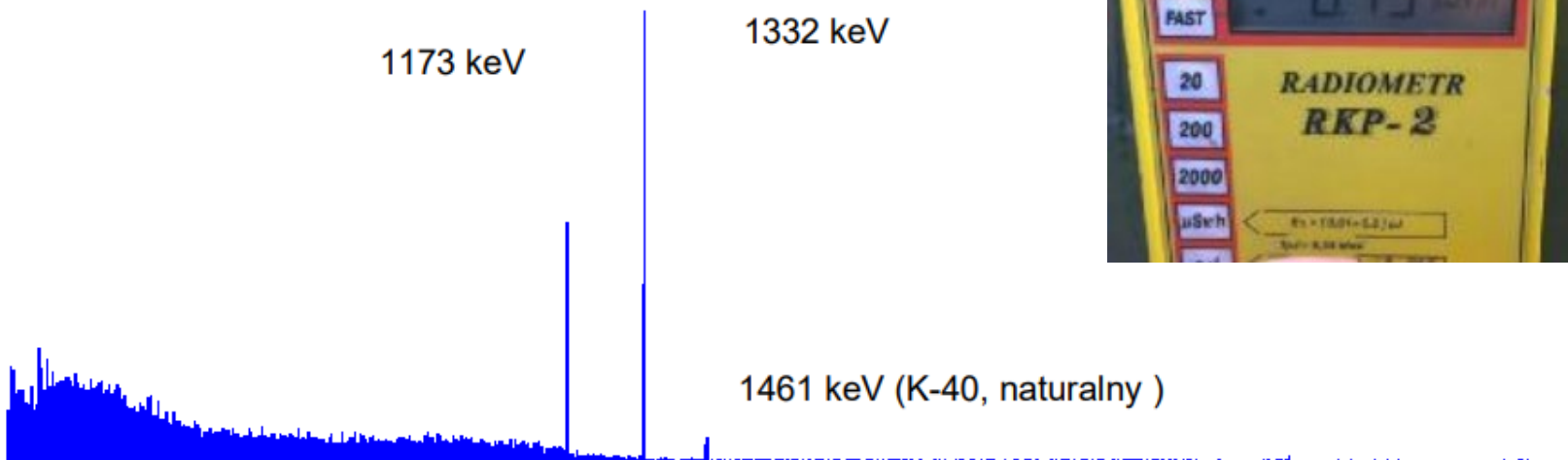

Duants of the cyclotron U-120: weight ~a few tons.

The gamma energy spectrum measured on the surface of the duants of the cyclotron U-120.



# Public exposure

- People living around a radiotherapy facility
- Visitors to the department
- Relatives, friends and other persons who may be in contact with patients
- Staff from other departments/divisions
  - contractors
  - electricians
  - painters
  - plumbers

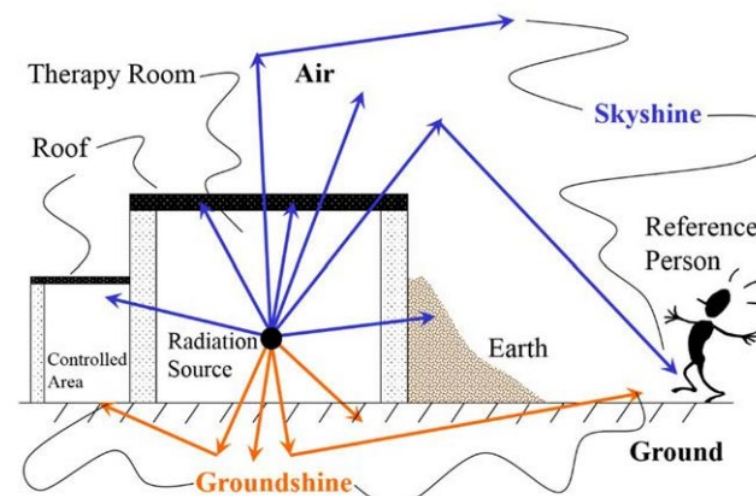

IAEA-TECDOC-1891, *Regulatory Control of the Safety of Ion Radiotherapy Facilities*

# Ambient doses outside the CCB

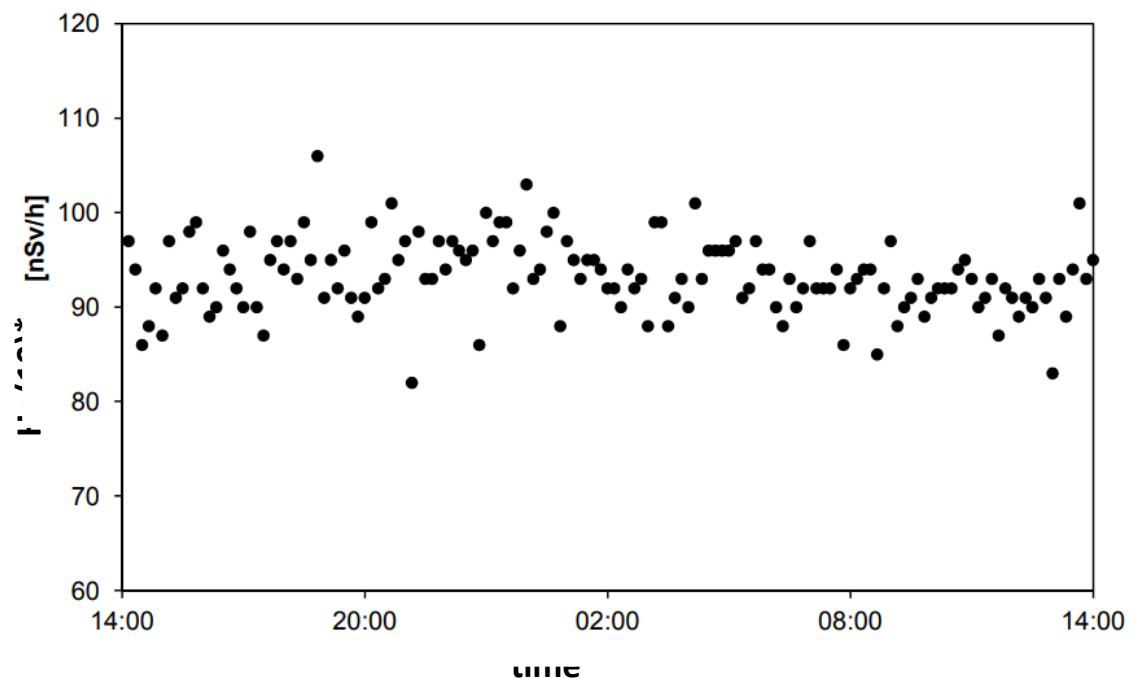

*The ambient dose rate measured outside the CCB building.*

- The dose rate measured outside the CCB is on the level of the natural background
- No artificial isotopes were recorded in the gamma spectra

*S.Gugula, PhD thesis, Promieniotwórczość gamma wzbudzona w środowisku cyklotronu Proteus C-235*

# SUMMARY

---

- + Compared with electron and photon, proton delivers more energy and dose at its end of the range (Bragg peak), and has less lateral scattering for its much larger mass.
  - + Out-of-field patient doses in proton therapy are not taken into account by the treatment planning system, because they are relatively small.
  - + The activation levels of patients are extremely low, so specific protective actions are not done after irradiation for patients.
  - + If a radiotherapy department is designed well, the risk of public and medical staff exposure is usually very small.
  - + For short-lived isotopes activated materials, they can be removed from the room after checking that the activated level is as low as the background level
  - + The activation levels of air in the therapy room are very low, and only ordinary ventilation is used.
- Interacting protons produce neutrons and induced radioactivity, which makes radiation protection for proton facilities more difficult than for electron accelerators.
  - The sharp dose gradients associated with modern treatment techniques, require more frequent and accurate patient imaging than conventional treatment techniques at the cost of an increased patient dose.
  - There is an increasing need to include out-of-field doses in the dose calculation, doses obtained during the planning/verification purposes especially when treating children, pregnant patients, and patients with implants.
  - Induced radioactivity produced in an accelerator and its beam-line components may cause maintenance workers' exposure and make the disposal of activated components difficult.
  - In case of cyclotron malfunction there is no time to wait to completely cool down the activity, so service engineers receive enhanced doses.

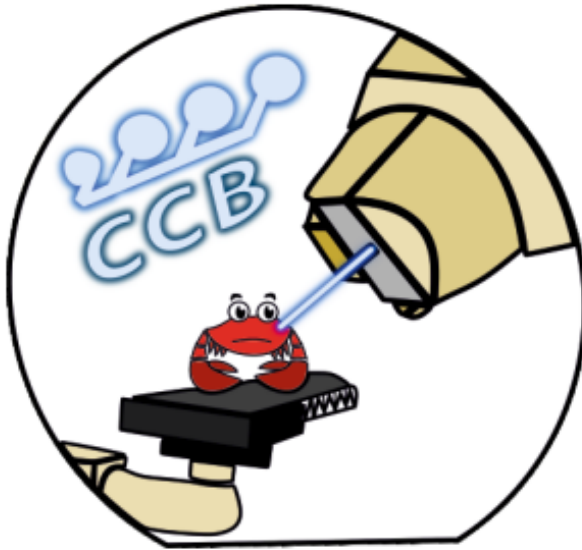

Thank you for your attention!

[agnieszka.szumska@ifj.edu.pl](mailto:agnieszka.szumska@ifj.edu.pl)