

Final report

# Average EU building heat load for HVAC equipment

Specific contract No. ENER/C3/412-2010/15/FV2014-558/SI2.680138  
with reference to Framework Contract ENER/C3/412-2010

René Kemna, VHK  
Prepared for the European Commission  
DG ENER C.3  
Juan Moreno Acedo  
Office: DM24 4/14  
BE-1049 Brussels, Belgium  
[juan.moreno-acedo@ec.europa.eu](mailto:juan.moreno-acedo@ec.europa.eu)



Van Holsteijn en Kemna B.V. (VHK)  
Elektronicaweg 14  
2628 XG Delft  
The Netherlands  
[www.vhk.nl](http://www.vhk.nl)

Delft, August 2014

**IMPORTANT NOTICE:**

1.

The sole responsibility for the content of this report lies with the authors. It does not necessarily represent the opinion of the European Community. The European Commission is not responsible for any use that may be made of the information contained herein.

2.

The data in this report under the contract have been retrieved and analysed to the best of the author's ability and knowledge. However, many forward looking statements are implicit or explicitly presented for which neither contractor nor the author personally assume any liability from damages that may arise from the use of these documents and the data therein.

## GLOSSARY

CDD	Cooling Degree Days	<i>Parameters</i>	
CH	Central Heating	A	floor surface area building [m <sup>2</sup> ]
EC	European Commission	cair	specific heat air [Wh/ m <sup>3</sup> .K]
ECCP	European Climate Change Programme	Q	heat/energy [kWh]
ED	Ecodesign	q	hourly air exchange [m <sup>3</sup> .h <sup>-1</sup> / m <sup>3</sup> ]
EEA	European Environmental Agency	rec	ventilation recovery rate [-]
EIA	Ecodesign Impact Accounting (study)	S	shell surface area building [m <sup>2</sup> ]
EL	Energy Labelling	SV	shell surface/volume ratio building
ENER	EC, Directorate-General Energy	t	heating season hours [h]
EnEV	Energie Einsparungs Verordnung (DE)	T <sub>in</sub>	Indoor temperature [°C]
ENTR	EC, Directorate-General Enterprise	T <sub>out</sub>	outdoor temperature [°C]
ENTRANZE	Policies to ENforce the TRAnSition to Nearly Zero Energy buildings in the EU-27	U	insulation value in [W/K. m <sup>2</sup> ]
EPBD	Energy Performance of Buildings Directive	V	heated building volume [m <sup>3</sup> ]
EPG	Energie Prestatie Gebouwen (NL)	ΔT	Indoor-outdoor temperature difference [°C]
EPISCOPE	Energy Performance Indicator Tracking Schemes for the Continuous Optimisation of Refurbishment Processes in European Housing Stocks	η	(heating boiler) efficiency [-]
GIS	Geographical Information System		
HDD	Heating Degree Days	<i>Units</i>	
HVAC	Heating, Ventilation & Air Conditioning	€	Euro
IEA	International Energy Agency	°C	degree Celsius
JRC	EC DG Joint Research Centre	a	annum (year)
NACE	Statistics classification by Economic Activity	bn	billion (1000 million)
NUTS	Classification of EU areas	CO <sub>2</sub>	carbon-dioxide (equivalent)
PBIE	Building Performance Institute Europe	h	hours
pef	primary energy factor	K	degree Kelvin
RT	Réglémentation Thermique (FR)	kWh	kilo Watt hour
SAP	Standard Assessment Procedure (UK)	m	metre or million
SCOP	Seasonal Coefficient Of Performance	m <sup>2</sup>	square metre
SEER	Seasonal Energy Efficiency Ratio	m <sup>3</sup>	cubic metre
TABULA	Typology Approach for Building Stock Energy Assessment	W	Watt
UHI	Urban Heat Island		
VHK	Van Holsteijn en Kemna (author)		

## EXECUTIVE SUMMARY

The space heating and –cooling load of buildings is a vital component in determining the energy consumption of space heating, ventilation and air conditioning (HVAC) equipment. This equipment is the largest contributor to the total EU energy consumption.

In the ongoing effort of the European Commission to assess the energy impact of all Ecodesign-regulated products it is important that –despite the lack of robust EU-wide statistics-- the best possible estimate for this parameter is used.<sup>1</sup>

This study aims to make that assessment, whereby for space heating the load is derived from a building model including average EU indoor- and outdoor temperatures, transmission and ventilation losses, etc.. The outcome of that model is then checked against the energy consumption and heating system efficiency. For space cooling the building load very much depends on local and behavioural circumstances and can only be derived indirectly, i.e. from equipment parameters.

Regarding the inputs for the space heating load, the most important conclusions are that

- Building-related average climate parameter values should be population-weighted and not surface weighted for heat load assessments. For instance, Eurostat's 2009 average of 3076 heating degree days (HDD) in the EU is surface-weighted and at least 14% higher than a population weighted equivalent of 2635 HDD.
- As a result of the above, the outdoor temperature that applies to average EU building stock during the 7 month heating season is 7 °C, which is considerably higher than the surface-weighted average often used. Considering only buildings with heating systems that are in the Ecodesign-scope, i.e. without district heating, the average outdoor temperature is 7.5 °C.
- The average 24h indoor temperature during the heating season is estimated at 18 °C. After correction for solar gains (1.2 °C) and internal gains (2.3 °C), the reference indoor temperature in the model calculations is 14.5 °C.
- The total heated surface area of the EU building stock –weighted to 18 °C indoor temperature—is estimated at 32.8 billion m<sup>2</sup>, of which 21.2 billion m<sup>2</sup> (65%) residential, 8.1 billion m<sup>2</sup> (24%) tertiary and 3.5 billion m<sup>2</sup> (11%) industrial sector. This is significantly higher than most (preliminary) figures in EPB-related research projects, mainly due to the contribution of the non-residential sector. An extensive overview of the non-residential subsector building geometry is given (see also Summary Table hereafter).
- The average U-value (insulation value) of the EU building stock, in W/m<sup>2</sup>.K, is estimated at 0.93, based on 2.32 for windows (20% of the building shell surface), 0.625 for walls (30%), 0.5 for roofs (25%) and 0.625 –including cold bridges—for the floor (25%). Data availability does not allow a further breakdown per sector.

---

<sup>1</sup> Kemna, R.B.J., *Ecodesign Impact Accounting*, VHK for the European Commission, May 2014.  
[http://ec.europa.eu/energy/efficiency/studies/efficiency\\_en.htm](http://ec.europa.eu/energy/efficiency/studies/efficiency_en.htm)

- The average hourly air exchange rate for ventilation (including infiltration), in  $\text{m}^3\cdot\text{h}^{-1}$  air exchange per  $\text{m}^3$  of heated building volume, is estimated at 0.86. The heat recovery rate is 7%, which means that the ventilation heat loss should be calculated with an effective rate of 0.82. Per sector the effective air exchange rates are 0.68 for the residential, 1.15 for the tertiary and 0.71 for the industrial sector.

Based on the above inputs, the calculated total EU space heating load is 2823 TWh, of which 1702 TWh (60.3%) in the residential, 677 TWh (24%) in the tertiary sector and 443 TWh (15.7%) in the industrial sector. Of this total, 2009 TWh (71%) is estimated to be in the scope of —heating systems addressed by the Ecodesign directive. The rest relates to buildings heated by district heating, process waste heat, the low-temperature output of large (steam) boilers and CHP installations, etc..

The future trend in the total EU space heating load can be expected to be more or less stable. Improved insulation, optimised ventilation (with heat recovery), increased urbanisation (heat islands) and global warming will lead to a decrease of the load. Growth of population, dwelling size and comfort level will lead to an increase of the space heating load. A new phenomenon is the diminished contribution of internal heat gains from lighting and appliances due to efficiency improvement, which will contribute to an increase of the heating load for space heating systems.

Space cooling demand, which is treated separately from space heating demand in the report, is expected to continue to rise. Local climate conditions, economical and behavioural characteristics play a dominant role and deriving demand from EU averages is —at least at the moment— not possible. When derived from the installed equipment it can be derived that EU cooling demand in 2010 amounted to 220 TWh (8% of the space heating demand). According to the EIA projections space cooling demand is expected to rise to 305 TWh (+38%) in 2020 and 379 TWh in 2030. Residential (room) air conditioners are expected to represent the largest growth in space cooling, albeit lower than indicated in ecodesign impact accounting.

In conclusion, the space heating loads for EU-buildings estimated here are deviate 11% (2010) and 4% (2020) from those used in Part 1 of the Ecodesign Impact Accounting report (EIA). This is a relatively modest deviation, given the large uncertainties in input data. It is recommended to make the appropriate adjustments, higher load and higher system efficiency for boilers, in EIA-Part 2. The recommended values of e.g. a higher load and system efficiency for boilers are contained in accompanying spreadsheet files. The consequences of the changes for the EIA projected savings are minor: 5 percentage points less savings on space heating and 0.3 percentage points (on an absolute figure of 19%) less overall savings in 2020 and 2030.

For space cooling, where the uncertainties in the load assessment are larger than for space heating, there is as yet no reason to correct the estimated loads in the Ecodesign impact accounting.

SUMMARY TABLE: HEAT LOAD CHARACTERISTICS AVERAGE EU BUILDING STOCK 2010

<b>TEMPERATURES</b> for average 7 month heating season (t =4910 h)			
<b>Outdoor Temperature T<sub>out</sub></b>	<b>°C</b>	<b>Indoor Temperature T<sub>in</sub></b>	<b>°C</b>
Surface-weighted average	~3.5-4	indoor 24h average	18
Population-density weighted average	6.5	correction solar gain	1.2
Correction for local effects (e.g. urban heat island)	0.6	correction internal gain	2.3
Average EU building T <sub>out</sub>		Average EU building T <sub>in</sub>	
	~7.0		14.5
<i>Indoor/outdoor temperature difference (all) ΔT = 7.5 °C</i>			
Correction for district heating (DH)	0.4		
Average EU building, excluding buildings heated by district heating	7.5		
<i>Indoor/outdoor temperature difference (excl. district heating) ΔT =7 °C</i>			

**GEOMETRY** (heated surfaces and volumes, at 18 °C, ~2010)

<b>Parameter, unit</b>	<b>Symbol</b>	<b>Residential</b>	<b>Tertiary</b>	<b>Industrial</b>	<b>EU Total</b>
Floor area, in bn m <sup>2</sup>	A	21.2	8.1	3.5	32.8
Ground floor area, in bn m <sup>2</sup>	A <sub>G</sub>	7.0	3.4	2.9	13.3
Shell area, in bn m <sup>2</sup>	S	31.7	10.4	6.7	48.8
Volume, in bn m <sup>3</sup>	V	62	32	20	114
Shell surface/ volume ratio	SV	0.51	0.32	0.33	0.43

**PHYSICS**

<b>Parameter, unit</b>	<b>Symbol</b>	<b>Windows</b>	<b>Walls</b>	<b>Roof</b>	<b>Floor</b>
Insulation value in W/m <sup>2</sup> .K		2.32	0.625	0.50	0.625
Share of total shell surface	-	20%	30%	25%	25%
Average U value,	U	0.93			
		Residential	Tertiary	Industrial	EU Total
Ventilation air exchange, in m <sup>3</sup> .h <sup>-1</sup> /m <sup>3</sup>	q(1-rec)	0.68	1.15	0.71	0.82

**TOTALS**

Space heating load, in TWh/a	Q <sub>building</sub>	$=0.001 \cdot \Delta T \cdot t \cdot [S \cdot U + V \cdot q(1-rec) \cdot c_{air}]$ $=0.001 \cdot 7.5 \cdot 4910 \cdot [48.8 \cdot 0.93 + 114 \cdot 0.82 \cdot 0.343]$ $\approx 2860$			
		Residential	Tertiary	Industrial	EU Total
Space heating load, in TWh		1725	687	448	2823
Space cooling load, in TWh					490
Space cooling output 2010, in TWh		56	164		220

# TABLE OF CONTENTS

<b>1</b>	<b>INTRODUCTION.....</b>	<b>8</b>
1.1	Background	8
1.2	Specific tasks	9
1.3	Timing & deliverables	10
1.4	Report structure	11
<b>2</b>	<b>HEAT DEMAND MODEL .....</b>	<b>12</b>
2.1	Basics and sources	12
2.2	Modelling	13
<b>3</b>	<b>TIME AND TEMPERATURES.....</b>	<b>16</b>
3.1	Introduction	16
3.2	Outdoor temperature and heating season	16
3.2.1	Reference values from Ecodesign preparatory studies	16
3.2.2	Reference values in Ecodesign regulations	19
3.2.3	Eurostat heating degree days	20
3.2.4	Local temperature differences and urban heat islands	22
3.2.5	Global warming	29
3.3	Indoor temperature	30
3.3.1	Building codes and –standards	30
3.3.2	Measurements	33
3.3.3	Fluctuation and stratification losses	34
3.3.4	Internal gain	36
3.3.5	Solar gain	38
3.4	Conclusion on temperature difference	42
<b>4</b>	<b>VOLUMES AND SURFACES .....</b>	<b>43</b>
4.1	Introduction	43
4.2	Data sources	49
4.3	Secondary EU data sources	51
4.3.1	ECCP	51
4.3.2	National statistics offices	51
4.3.3	EPBD	51
4.3.4	Ecodesign preparatory studies	52
4.4	SV ratio	52
4.5	Volumes and surfaces	54
4.6	Volumes and surfaces: average and totals	58
<b>5</b>	<b>INSULATION AND VENTILATION.....</b>	<b>60</b>
5.1	Definition	60
5.2	U-value (insulation)	60
5.3	Ventilation rates and recovery	61

<b>6</b>	<b>HEAT LOAD.....</b>	<b>64</b>
6.1	Calculation	64
6.2	Ecodesign coverage of space heating load	65
6.3	Eurostat Energy Balance	66
6.4	Converting the Energy Balance to a space heating balance	68
6.5	Conclusion	69
<b>7</b>	<b>TREND .....</b>	<b>71</b>
7.1	Introduction	71
7.2	General	71
7.3	Central heating boilers	72
7.4	Local space heaters	73
7.5	Solid fuel boilers	74
7.6	Central air heating equipment	74
7.7	Reversible room air conditioners ( heating )	75
7.8	Conclusion on trends	76
<b>8</b>	<b>SPACE COOLING .....</b>	<b>78</b>
8.1	Introduction	78
8.2	Outdoor temperature and cooling season	79
8.3	Latent heat	81
8.4	Modelling outcome for space cooling demand	81
8.5	Comparison to Ecodesign Impact Accounting and trend	81
8.6	Conclusions space cooling	82
	<b>REFERENCES.....</b>	<b>83</b>
	<b>ANNEX A : HEATING DEGREE DAYS POPULATION-WEIGHTED .....</b>	<b>86</b>
	<b>ANNEX B: EU LAND COVERAGE 2012 (LUCAS) .....</b>	<b>90</b>
	<b>ANNEX C: EVALUATION BUILDING VOLUME ACCURACY, GERMANY.....</b>	<b>91</b>
	<b>ANNEX D: FUNCTIONAL UNITS, CAPITA SELECTA.....</b>	<b>94</b>
	<b>ANNEX E: ENEC ENERGY BENCHMARKS .....</b>	<b>107</b>



# 1 INTRODUCTION

## 1.1 Background

The ongoing specific contract<sup>2</sup> on ‘Ecodesign Impacts Accounting’ (EIA) entails, as one of its main tasks, the presentation of a harmonised compilation of the quantitative results of concluded and ongoing preparatory studies and impact assessment reports for Ecodesign, Energy Labelling, Tyre Labelling and EU Energy Star for the period 2010-2050 (with five year intervals).

In a dynamic model this implies, although not explicitly part of the deliverables of the specific contract, that for most products the relevant parameters have to be traced back to 1990 or earlier to deliver meaningful and consistent results for 2010 and onwards. The aim of this specific contract ‘Ecodesign Impacts Accounting’ is, through systematic monitoring, to provide the European Commission with improved means of strategic decision support (i.e. understanding the impacts of policies measures and actions over time) as well as improving its forecasting and reporting capacity. Furthermore, the harmonised compilation is to serve as an input to specific ongoing and future related activities, such as the development of the ‘POTEnCIA’ model (previously ‘E-model’) by JRC-IPTS, setting up of an EU product databases as well as the imminent review of key legislation already in place (e.g. the Energy Labelling Directive).

In order to meet these aims, the harmonised calculation method not only has to follow specific methods such as MEERp<sup>3</sup> and the Commission's impact assessment guidelines<sup>4</sup>, but also has to be compatible with the energy accounting methods of Eurostat (which are also adopted in POTEnCIA). Amongst others this allows strategic decision support that is embedded in the whole of EU policy.

Intermediate results<sup>5</sup> from the specific contract show that a fairly close match between the ‘bottom-up’ approach from the individual Ecodesign preparatory studies and IA reports and the ‘top down’ approach from Eurostat would be possible. As such, the outcomes of the specific contract could play an important role in the POTEnCIA model, also according to JRC-IPTS<sup>6</sup>.

At the moment, the matching of bottom-up and top-down data is best for the EU electricity consumption.

For fossil fuels and for HVAC equipment in general, the main focus of the preparatory studies and IA reports (and thus also of the harmonised compilation of the quantitative results of concluded and

<sup>2</sup> Specific contract ENER/C3/412-2010/FV575-2012/12/SI2.657835, signed on 2 Sept. 2013. Report: Kemna, R.B.J., Ecodesign Impact Accounting – Part 1, VHK for European Commission, June 2014.

<sup>3</sup> Methodology for Ecodesign of Energy-related Products See [http://ec.europa.eu/enterprise/policies/sustainable-business/ecodesign/methodology/index\\_en.htm](http://ec.europa.eu/enterprise/policies/sustainable-business/ecodesign/methodology/index_en.htm)

<sup>4</sup> For details refer to IA guidelines:

[http://ec.europa.eu/comm/secretariat\\_general/impact/docs/SEC2005\\_791\\_IA\\_guidelines\\_main.pdf](http://ec.europa.eu/comm/secretariat_general/impact/docs/SEC2005_791_IA_guidelines_main.pdf), Annex to IA guidelines: [http://ec.europa.eu/governance/impact/docs/SEC2005\\_791\\_IA\\_guidelines\\_anx.pdf](http://ec.europa.eu/governance/impact/docs/SEC2005_791_IA_guidelines_anx.pdf)

<sup>5</sup> Results presented by the contractor to the EC at a meeting 14.1.2014.

<sup>6</sup> Minutes from VHK-IPTS meeting 5 Feb. 2014. Cit. ‘*Even though IPTS and VHK data are more or less in line (taking into account the different definitions of efficiencies), IPTS would prefer to base its data on the data from VHK as the latter is based on a larger data sample and is consensual among stakeholders*’

ongoing preparatory studies and impact assessment reports for Ecodesign/Labelling) has been on the energy efficiency (and emissions) of the equipment, while the heat load of the buildings, which is equally important in establishing the absolute energy consumption, has been treated more superficially.

In some Ecodesign lots (e.g. ENER Lot 1 'Heaters', ENTR Lot 6 'Large airco and ventilation units', ENER Lot 32 'Windows') an attempt was made to derive heat load demands from the evolution of estimated building and climate characteristics, but for most equipment the load was derived from the equipment capacity (kW) and estimated full-capacity annual operating hours that are fixed over time.

While this may be plausible from the specific purpose of the preparatory studies and IA reports, and the uncertainties of available EU building and climate data at the time of the studies, it would be an important asset for strategic decision support if the harmonised data were to be (re)calculated with the latest findings on the average heat load of the building sites.

This data is not readily available. In the context of the EPBD<sup>7</sup> there is a continuous effort to retrieve European residential building data in projects such as ENTRANZE<sup>8</sup> or EPISCOPE<sup>9</sup> and its predecessor TABULA<sup>10</sup>. These projects result in reference buildings at the level of individual Member States. But, also according to the authors, much work needs to be done before arriving at consensual and consistent EU averages.<sup>11</sup> Data acquisition for the non-residential sector is only starting up, but some first data are available in the context of some project.

## 1.2 Specific tasks

The scope of this assignment with limited resources is the argued assessment of the average EU building heat loads specifically for HVAC equipment, based on existing source material. The analysis and reporting will thus be commensurate with that scope and not beyond.

The project entails performing the following tasks:

1. To retrieve and to analyse currently available European building and climate data from the above sources, i.e. both from the relevant Ecodesign lots and from the EPBD-type projects, and to aggregate (or disaggregate) as necessary;
2. To combine the building data with the technical characteristics of the HVAC equipment, as established in the context of the specific contract 'Ecodesign Impact Accounting', and the aggregated data from the Eurostat Energy Balance

<sup>7</sup> Energy Performance Building Directive 2010/31/EU.

<sup>8</sup> ENTRANZE. *Policies to ENforce the TRAnSition to Nearly Zero Energy buildings in the EU-27*. Project co-funded by the Intelligent Energy Europe programme of the EU. See <http://www.entranze.eu>.

<sup>9</sup> EPISCOPE. *Energy Performance Indicator Tracking Schemes for the Continuous Optimisation of Refurbishment Processes in European Housing Stocks*. Project co-funded by the Intelligent Energy Europe programme of the EU (2013-2016). See [www.episcope.eu](http://www.episcope.eu).

<sup>10</sup> TABULA: *Typology Approach for Building Stock Energy Assessment*. Project co-funded by the Intelligent Energy Europe programme of the EU (2009-2012, predecessor of EPISCOPE). See [episcope website](http://www.episcope.eu) as a portal.

<sup>11</sup> Aleksandra Arcipowska, Buildings Performance Institute Europe (BPEI), *Making European Buildings Data useful for policy making process*, Contribution to European Data Forum, Athens, Greece (19-20 March 2014).

3. To make a consistent and argued building and climate heat demand model for the buildings to fit all of the above sources.
4. To change the load data in the harmonised compilation of HVAC equipment according to the calculated building heat/cooling load demands.
5. To retrieve and to analyse the currently available fossil fuel data for HVAC equipment from the relevant Ecodesign lots, and to aggregate (or disaggregate) as necessary.
6. To include the retrieved data in the Excel files of the specific contract 'Ecodesign Impact Accounting' to fine-tune the 'bottom-up' approach from the individual Ecodesign data.

All activities are to be pursued in close collaboration with the Commission Policy Officer(s). The Commission will provide the contractor(s) with all relevant information material at the outset of the study and will keep the contractor informed of any new developments during the study.

### 1.3 Timing & deliverables

The starting date is the signature date of the contract, i.e. the 8<sup>th</sup> of April 2014. A kick-off meeting between contractor and the Commission Policy Officer took place the 8<sup>th</sup> of April 2014. A draft final report was delivered the beginning of July 2014 and commented by the policy officer at the end of July. The following time schedule is illustrative.

**Table 1: Time schedule**

Timeline					
2014	April	May	June	July	
<b>Tasks* milestones</b>	<b>&amp;</b>	Kick-off meeting	Task 3	Task 5	Draft report & spreadsheet for approval, possible correction following comments, final report
		Task 1	Task 4	Task 6	
		Task 2			

\*= Tasks as defined in paragraph 1.2

The study deliverables are in the form of a compact background report and relevant spreadsheets.

The scope of the background report is to document how the average EU building heat/cooling loads are calculated from the various sources, including a brief discussion of deficiencies or missing data in the source material, and how the heat loads are partitioned to the various types of HVAC equipment.

Note that for this limited assignment it is explicitly not intended that the background report gives a comprehensive overview of the content of existing source material that is included in reports prepared by third parties for the European Commission and can thus be assumed to be known to the Commission.

A separate Excel file is delivered that shows the differences with the current results from preparatory and IA studies. On request and at the end of the contract, the Contractor shall make all the modelling

tools (Excel tables or other), including all data, freely available to the Commission for further use, with appropriate instructions.

## 1.4 Report structure

The report is not subdivided into task reports but follows a logical structure for the reader.

The largest part of the report deals with the estimation of the space heating load, which can be derived from average EU input parameters and which constitutes the largest part of the total. The Chapters 2 to 8, although they contain information that is largely also relevant for space cooling<sup>12</sup>, deal exclusively with space heating.

Assessment of EU space cooling demand depends very much on local circumstances, behavioural aspects and economic considerations. As such, it requires a different approach which will be discussed in a separate chapter 8.

- Chapter 2 describes the general building heat demand model (Task 3)
- In the subsequent chapters 3 to 5 each element of this basic model is discussed to identify appropriate values and possible caveats for outdoor and indoor temperatures, building geometry, insulation & ventilation (Tasks 1 and 2).
- Chapter 6 gives the static modelling outcome and investigates the quality and the plausibility of the estimate for the EU building heat load by confronting the values found with the heating energy consumption derived from Eurostat's Energy Balance sheets and the heating system efficiency values from the EIA (Task 4 & 5 for reference year 2010).
- Chapter 7 discusses future trends in building heat demand (Task 4 & 5 for 2010 onwards).
- As mentioned, space cooling demand is discussed separately and is the subject of chapter 8.

The Excel file with the proposed modifications for the Ecodesign Impact Accounting (Task 6) is a separate deliverable, but the main modifications and their consequences are mentioned at the end of Chapter 7.

---

<sup>12</sup> E.g. data on building geometry, outdoor temperatures and solar radiation in summer, etc..

## 2 HEAT DEMAND MODEL

### 2.1 Basics and sources

The heat<sup>13</sup> demand of the building  $Q_{building}$ , in kWh/a, is the effective heat that a space heating system needs to deliver over the heating season in order to bring and keep the interior space at the desired temperature for the desired time periods.

The building heat demand is one of the two parameters –the other being the heating system efficiency  $\eta_{heating\_system}$ —that determine the annual energy consumption of heating systems  $Q_{heating\_energy}$ , expressed in kWh/a of the Net Calorific Value of the space heating system.

$$Q_{heating\ energy} = \frac{Q_{building}}{\eta_{heating\ system}}$$

The heat demand of the building is a vital part of the impact accounting of Ecodesign and energy labelling measures that aim at improving the efficiency important parts of the heating system like boilers, reversible air conditioners, heat pumps, etc.. Modelling of the building heat load/demand has been included in preparatory Ecodesign and impact assessment studies, for

- central heating boilers (Lot 1),
- room air conditioners (Lot 10),
- solid fuel boilers (Lot 15),
- local space heaters (Lot 20)
- central air heaters (Lot 21) and
- ventilation units and central comfort air cooling (ENTR Lot 6).

Furthermore, heat load calculations have been included in a recent study investigating the feasibility of Ecodesign and labelling measures for thermal insulation (Lot 35, VITO 2014) and in the ongoing study on windows (Lot 32, ift Rosenheim/VHK/VITO).

Modelling (parts of) the average building heat demand for energy policy making has been the subject of several policy studies regarding energy performance of buildings (EPB) over the last decades, including the

- European Climate Change Programme (ECCP 2001-2003)
- Odyssee database (ongoing)
- ENTRANZE
- EPISCOPE and TABULA
- Concerted Action in the context of the EPBD

Much work is ongoing and needs to be done to improve the accuracy and level of detail. As the subject is important for the accuracy of –amongst others-- assessing Ecodesign and energy labelling impacts it is crucial that not only the figures from preparatory studies are retrieved but that the

---

<sup>13</sup> Hereafter, ‘heat’ or ‘heating’ implicitly includes ‘cool’ or ‘cooling’ (negative heat demand)

latest insights into the subject from all sources is taken into account. Having said that, the current study does not intend to generate new field data, but instead aims to make the best estimate from the available sources.

## 2.2 Modelling

The building heat demand follows from the sum of transmission and ventilation losses minus solar and internal gains. In this context, *transmission losses* are understood to contain not only the heat flow through the building shell (walls, windows, roofs and floors), but also the possible conduction losses from linear cold bridges between building elements. *Ventilation losses* include both the heat loss from infiltration of air from openings in the building shell (a.k.a. ‘infiltration losses’) as well as the intended air exchange from window openings and/or mechanical ventilation units (‘ventilation losses’ in a strict sense). *Solar gains* mainly result from solar radiation through the windows<sup>14</sup> and *internal gains* include all heat produced by people and (non-heating) appliances.

The above parameters are common to all building heat load modelling. The complexity of the modelling depends on its specific purpose and can range from dynamic, finite-element models for building science<sup>15</sup> to static (annual) models to establish energy performance of buildings (EPB)<sup>16</sup>. For energy policy purposes simplified versions of the static model are commonly used, whereby for example the solar and internal gains are not calculated as separate energy entities but are implicitly taken into account through deductions on the indoor temperature.<sup>17</sup> Also the restrictions posed by thermal mass<sup>18</sup> (i.e. limiting the night setback temperature) as well as the internal heat transfer between various heated and unheated zones are not explicitly incorporated in the model, but again are assumed to be taken into account in the reference indoor temperature.

These simplifications do not make the policy-oriented models less valid; they merely treat certain related clusters of technical parameters at a more aggregated level.

In the policy-oriented models, the instantaneous transmission losses are the product of the indoor-outdoor temperature difference (in degrees Kelvin, K), the shell surface area (in m<sup>2</sup>) and the thermal transmission coefficient (usually the ‘U-value’ in W/K.m<sup>2</sup>). The shell surface area is subdivided in wall-

<sup>14</sup> With ‘windows’ it is intended --in this report-- all transparent and semi-transparent building elements.

<sup>15</sup> CFD (Computational Fluid Dynamics) thermal and flow models.

<sup>16</sup> For example EN ISO 13790:2008 (Thermal performance of buildings - Calculation of energy use for space heating and cooling) or similar models used in national building codes related to energy performance of buildings.

<sup>17</sup> This is e.g. the case in the calculation of heating degree days (HDD). Also in Ecodesign studies for space heating and – cooling appliances this is the common practice (compare e.g. bin-hours discussed hereafter)

<sup>18</sup> Thermal inertia of the building mass influences dynamic heating behaviour (heat-up, cool-down). It may have an impact on indoor temperature setback regimes. For instance, in a ‘heavy’ construction night-time setback may result in only one or two degrees lower night-time temperature at the expense of a high power (less efficient) heat input from the boiler in the morning to get the temperature back to a comfortable day-time temperature. In a ‘light’ building construction a night-time setback is more useful (saving much more). For a simple model, however, assuming an ‘average’ thermal building mass these effects are assumed to even out. For more details, see e.g. the Ecodesign preparatory study on Lot 1, Task Likewise, where building orientation –especially window orientation-- is relevant for the heat load of individual houses, but it is assumed that for the whole of the EU it is assumed that, even if there is an average prevalence (e.g. less East-oriented windows), the effect evens out and will be implicitly taken into account in other parameters. Or prevalent average building orientation and position (near mountain, near sea, urban versus rural area) in combination with the influence of wind, solar radiation and heat island effect (cities being warmer as buildings are closer together) if parameters deviate from the average.

, window-, roof- and floor-area, each with their respective U-values<sup>19</sup>, in order to produce a shell-surface weighted average U-value.

The ventilation losses are the product of the indoor-outdoor temperature difference (in K), the building volume (in m<sup>3</sup>), the hourly air exchange (in m<sup>3</sup>.h-1/m<sup>3</sup>), the specific heat capacity of air (in W/m<sup>3</sup>.K) and the remaining fraction after taking into account heat recovery (dimensionless).

Several (national) building energy performance standards use the practice of expressing solar gains as a default value (in W/h) or a percentage of the indoor-outdoor temperature value in generic energy policy studies<sup>20</sup>. The same goes for the internal gains. This is the reason why, instead of the real average daily indoor temperature of 18 °C<sup>21</sup>, simple models often use a reduced indoor temperature of 16 °C.

A comprehensive assessment of solar heat gains for an individual building or dwelling is not a simple task. It results from the local solar radiation (in W/m<sup>2</sup>) as well as the orientation, position and geometry of the building(-windows) and surroundings. And very often such a task is not useful in an EPB context. Outdoor ambient temperatures are taken from meteorological data for reference locations. Relative humidity is not taken into account, because its effect is negligible for the determination of the space heating load.<sup>22</sup>

The textbox below shows the equation for the annual building space heating demand that will be used in this report.

---

<sup>19</sup> Which includes, as mentioned the possible effect of cold bridges.

<sup>20</sup> Note that this is the simplest possible form and only admissible for policy studies at the highest aggregation level, e.g. EU totals. In specific studies on windows, where the transparency (g-value) is an important parameter, this is not admissible. Also technical studies would typically incorporate the daily global solar irradiance, e.g. in kWh/m<sup>2</sup> per day, in the equation.

<sup>21</sup> A temperature of 18 °C is widely accepted as the average indoor temperature in the heating season. In residential dwellings it is a surface-weighted and time-of-day weighted average of living rooms (20-21 °C), bed rooms (16-17 °C), kitchen (18 °C) and bathroom (24 °C) with an average daily setback-regime. In a non-residential setting it is typically an average of daytime (21-22 °C) and night-time/weekend (17°C) temperatures e.g. for offices and other tertiary sector buildings.

<sup>22</sup> For space cooling the relative humidity (RH) of the outdoor air is relevant. For instance, when cooling air of 28 °C @80% RH (quite common in e.g. Southern Europe) to 22 °C @100% RH, there is some 5 g/m<sup>3</sup> that will condense. At a specific condensing heat of 2256 kJ/kg (627 Wh/kg) this means that, on top of the 'normal' specific heat of air in the formula, some 20-30% extra energy will be consumed.

### Annual building space heating demand

$$Q_{\text{building}} = 0.001 \cdot \Delta T \cdot t_{\text{heating}} \cdot [ S \cdot U + V \cdot q \cdot (1-\text{rec}) \cdot c_{\text{air}} ]$$

where

$Q_{\text{building}}$  is annual building space heating demand [kWh/a],

$\Delta T$  is indoor-outdoor temperature difference corrected for solar and internal gains [K]

$t_{\text{heating}}$  is heating season hours [h],

$S$  is heated shell surface area, built from areas for exterior walls, windows, floor, roof [m<sup>2</sup>],

$U$  is the average thermal transmission coefficient derived from shell surface area weighted specific U-values [W/m<sup>2</sup>.K],

$V$  is heated building volume [m<sup>3</sup>],

$q$  is hourly air exchange [m<sup>3</sup>.h<sup>-1</sup>/m<sup>3</sup>],

$\text{rec}$  is the fraction of heat recovered from outgoing air [-],

$c_{\text{air}}$  is specific heat capacity air [0.343 Wh/m<sup>3</sup>.K],

0.001 is the conversion factor from Wh to kWh.

To find the EU aggregate the value of  $Q_{\text{building}}$  can be multiplied by the number of buildings or—and this approach is chosen here—relate the values of  $S$  and  $V$  not to a ‘building’, with all its definition problems, but to the EU total heated shell surface and EU total building volume respectively.

The simple representation of  $Q_{\text{building}}$  is in line with ISO EN 13790 and other EU or national standards for the calculation of the annual building space heating demand<sup>23</sup>. It is also in line with the heat load formulas in preparatory Ecodesign studies, for Lot 1 (central heating boilers), 10 (room air conditioners), 15 (solid fuel boilers), 21 (central air heaters) and ENTR Lot 6 (ventilation units and central air coolers).

It may be difficult to read the similarities with more complex formulas in standards, because the formula contains several elements implicitly. For instance, instead of using the shell surface  $S$  directly, many formulas use the multiplication of building volume  $V$  and the  $SV$  (also ‘ $AV$ ’) ratio.

$$S = SV \cdot V$$

$SV$  is the ratio between the shell surface and the volume.

Also, consider that  $\Delta T$  implicitly contains the correction for internal and solar gains.<sup>24</sup>

<sup>23</sup> EnEV (Germany), SAP (UK), RT (France), EPG (Netherlands), etc..

<sup>24</sup> For instance, in formula:  $\Delta T = T_{\text{in}} - T_{\text{out}}$ , with  $T_{\text{in}}$ =corrected indoor temperature [°C] and  $T_{\text{out}}$ =outdoor temperature [°C], where

$$T_{\text{in}} = T_{\text{ref}} \cdot [1 - (Q_{\text{gain}} + Q_{\text{sol}})/Q_{\text{building}}]$$

with  $T_{\text{ref}}$ =real average indoor temperature e.g. 18 [°C];  $Q_{\text{gain}}$ = internal gain [kWh/a];  $Q_{\text{sol}}$ = solar gain [kWh/a];  $Q_{\text{building}}$ = space heating demand [kWh/a], determined experimentally<sup>24</sup>

And then  $Q_{\text{sol}}$  can be refined further:  $Q_{\text{sol}} = F \cdot q_{\text{sol}} \cdot \text{sgf}$ , with  $Q_{\text{sol}}$ =solar gain [kWh/a];  $F$ =heated floor area [m<sup>2</sup>];  $\text{sgf}$ = solar gains factor, depending on window size, -position, g-value, orientation, shadowing, etc.;  $q_{\text{sol}}$ =global solar irradiance over the heating season in kWh/m<sup>2</sup>.a (=sum of global solar irradiance per day or hour over heating season days or -hours).



## 3 TIME AND TEMPERATURES

### 3.1 Introduction

The temperature difference  $\Delta T$  [in °C or K] relates to the difference between the outdoor temperature [in °C] and the indoor temperature [°C], corrected for internal and solar gains, during the heating season hours.

In general, 'heating season' refers to the calendar period in which input from space heating devices may be required. In the EU this may vary between 4 months (e.g. Portugal) and 9 months (e.g. Sweden, Finland), with approximately 7 months as an average.

In the context of the modelling 'heating season hours', represented by parameter  $t_{\text{heating}}$  [in h], refers specifically to the number of hours in a year where the outdoor temperature, rounded to whole numbers, is 15 °C or lower.

The following paragraphs discuss outdoor temperature values from various sources (par. 3.2) and the available indoor temperature values with corrections for solar and internal gains (par. 3.3).

### 3.2 Outdoor temperature and heating season

#### 3.2.1 Reference values from Ecodesign preparatory studies

In the context of preparatory studies for the Ecodesign regulations for heat pumps (Lot 1, VHK) and room air conditioners (Lot 10, Armines) the average outdoor temperature was determined on the basis of meteorological data for the EU25 (in 2006-2007). On the basis of the PVGIS database (JRC-Ispra) outdoor temperatures per Member State capital and per average month-day, for 12 months, was established. Every month-day was subdivided in 5 periods that are relevant for space heating purposes: morning 7-9h (heat-up after night setback), midday 9-16h (low occupancy, largest solar contribution), evening 16-21h (high occupancy, maximum heat demand in most of dwellings), late evening 21-23h (medium occupancy, possible anticipation of setback), night (setback-period).

This assessment was now updated for the EU28 and the results are shown in tables 2a and 2b.

At the end of the Table some population-weighted averages are shown. The average whole year outdoor temperature (population weighted) is 11.2 °C, whereas for the typical heating season from October to April the average is 6.6 °C.

The number of heating hours can be calculated by taking only hours from day-periods where the rounded temperature value is 15 °C or lower, i.e. where the temperature is lower than 15.5 °C. In the period October to April this results in 4917 heating hours (out of a total of 5110 hours). The average strictly during these hours is 6.2 °C. Considering the influence of the thermal mass of the building there will be a carry-over from the non-heating hours in that period. For that reason it is considered that 6.5 °C is a plausible average.

AVERAGE EU BUILDING HEAT LOAD FOR HVAC EQUIPMENT

Table 2a . Outdoor temperatures EU-28, split-up in 5 time-periods per average month-day January-June, in °C (VHK calculation on the basis of JRC PVGIS for country capital, extract 2014)

time of day	EU28	AT	BE	BU	CR	CY	CZ	DK	EE	FI	FR	DE	GR	HU	EL	IT	LT	LI	LU	MT	NL	PL	PO	RO	SK	SI	ES	SE	UK
<b>Jan</b>	<b>2.9</b>	<b>-0.8</b>	<b>3.4</b>	<b>-0.6</b>	<b>-0.3</b>	<b>10.8</b>	<b>-1.2</b>	<b>0.9</b>	<b>-3.1</b>	<b>-4.1</b>	<b>4.0</b>	<b>0.3</b>	<b>8.3</b>	<b>-0.9</b>	<b>5.7</b>	<b>8.5</b>	<b>-2.6</b>	<b>-4.0</b>	<b>1.5</b>	<b>11.8</b>	<b>3.3</b>	<b>-2.2</b>	<b>10.6</b>	<b>-2.0</b>	<b>-0.6</b>	<b>0.6</b>	<b>5.9</b>	<b>-1.2</b>	<b>5.1</b>
7-9	1.8	-1.6	2.4	-2.0	-1.8	8.3	-1.9	0.5	-3.5	-4.2	2.9	-0.7	6.8	-2.0	5.1	6.5	-2.9	-4.6	0.5	10.8	2.5	-2.8	9.3	-3.3	-1.4	-1.2	3.3	-1.4	4.2
9-16	3.9	-0.1	4.0	1.1	1.5	14.6	-0.6	1.2	-2.7	-3.7	4.8	0.9	10.2	0.1	6.5	10.1	-2.2	-3.4	2.2	13.2	3.8	-1.5	12.1	-0.5	0.2	1.9	7.7	-0.9	5.9
16-21	4.0	-0.1	4.3	0.8	0.8	13.1	-0.7	1.2	-2.9	-3.8	5.1	1.0	9.6	0.0	6.2	10.5	-2.4	-3.6	2.3	12.7	4.0	-1.7	11.7	-0.4	-0.1	2.1	8.1	-1.1	5.9
21-23	2.9	-0.9	3.6	-2.0	-1.7	10.3	-1.5	0.9	-3.4	-4.3	4.2	0.3	7.9	-1.0	5.3	8.7	-3.0	-4.4	1.7	10.9	3.4	-2.5	9.8	-3.0	-0.7	0.7	6.2	-1.4	5.0
23-7	1.8	-1.6	2.5	-2.4	-1.9	6.8	-1.9	0.6	-3.4	-4.5	3.0	-0.5	6.3	-2.0	5.1	6.4	-3.0	-4.6	0.7	10.5	2.6	-2.8	9.1	-3.8	-1.4	-1.0	3.5	-1.4	4.3
<b>Feb</b>	<b>4.4</b>	<b>2.2</b>	<b>5.0</b>	<b>1.5</b>	<b>1.8</b>	<b>10.8</b>	<b>1.5</b>	<b>1.6</b>	<b>-3.5</b>	<b>-4.7</b>	<b>5.7</b>	<b>2.5</b>	<b>8.5</b>	<b>1.5</b>	<b>6.2</b>	<b>8.5</b>	<b>-2.3</b>	<b>-2.5</b>	<b>3.4</b>	<b>11.7</b>	<b>4.8</b>	<b>-0.1</b>	<b>11.9</b>	<b>1.2</b>	<b>2.1</b>	<b>2.6</b>	<b>7.4</b>	<b>-1.1</b>	<b>6.1</b>
7-9	2.7	0.4	3.8	-0.8	-0.6	8.6	-0.1	1.0	-4.2	-5.3	4.1	1.0	6.7	-0.8	5.2	6.1	-3.1	-3.5	1.9	10.6	3.8	-1.5	10.3	-1.3	0.2	-0.4	4.0	-2.0	4.8
9-16	6.0	3.9	6.0	4.0	4.6	15.1	2.9	2.3	-2.8	-3.8	6.9	3.6	11.1	3.8	7.2	11.0	-1.4	-1.5	4.5	13.5	5.7	1.0	13.7	3.9	3.9	5.1	10.1	-0.4	7.2
16-21	6.0	3.9	6.2	4.1	3.5	13.4	2.8	2.2	-3.0	-4.1	7.0	3.9	10.3	3.5	6.9	10.8	-1.5	-1.5	4.7	12.8	5.7	1.0	13.2	4.0	3.7	5.3	10.4	-0.5	7.2
21-23	4.3	2.2	5.1	1.0	-0.2	10.3	1.4	1.6	-3.9	-5.2	5.8	2.6	8.3	1.3	6.1	8.5	-2.6	-2.8	3.4	11.3	4.9	-0.2	11.5	-0.5	1.9	2.7	7.5	-1.3	6.1
23-7	2.5	0.2	3.7	-1.5	-0.6	6.1	-0.1	0.9	-4.3	-5.6	4.1	1.1	5.7	-1.1	5.1	5.5	-3.3	-3.6	1.9	9.9	3.8	-1.5	9.9	-2.0	0.0	-0.4	3.8	-2.0	4.7
<b>Mar</b>	<b>6.5</b>	<b>5.2</b>	<b>7.0</b>	<b>5.0</b>	<b>6.7</b>	<b>13.2</b>	<b>3.9</b>	<b>2.6</b>	<b>-1.1</b>	<b>-1.9</b>	<b>8.1</b>	<b>4.1</b>	<b>9.6</b>	<b>5.2</b>	<b>7.2</b>	<b>10.4</b>	<b>0.0</b>	<b>0.0</b>	<b>5.9</b>	<b>12.8</b>	<b>6.3</b>	<b>2.0</b>	<b>14.2</b>	<b>5.3</b>	<b>5.3</b>	<b>6.4</b>	<b>10.8</b>	<b>0.8</b>	<b>7.3</b>
7-9	4.8	3.6	5.5	2.2	3.9	11.9	2.3	1.8	-2.4	-3.4	6.4	2.4	8.2	3.0	6.3	9.0	-1.6	-1.8	4.1	12.1	5.4	0.5	12.7	2.2	3.4	4.0	7.7	-0.3	6.1
9-16	8.9	7.6	8.7	7.7	9.6	17.0	6.0	4.1	0.7	0.0	10.4	6.0	12.6	8.3	8.7	13.6	2.1	2.1	8.0	15.2	7.9	4.1	16.5	8.0	7.7	10.0	14.2	2.5	9.1
16-21	8.5	7.1	8.5	7.5	8.6	15.4	5.9	3.4	0.3	-0.2	9.9	6.1	11.6	7.9	7.9	12.5	1.9	2.1	7.8	14.0	7.4	3.9	15.7	8.2	7.3	9.6	14.2	2.0	8.5
21-23	6.2	4.9	6.8	4.0	4.9	12.5	3.7	2.2	-1.5	-2.3	7.8	4.0	9.1	4.8	6.8	9.8	-0.3	-0.4	5.7	12.3	6.1	1.7	13.7	4.4	5.0	5.9	10.5	0.5	7.0
23-7	3.8	2.4	4.9	2.0	4.2	8.9	1.4	1.0	-3.2	-4.2	5.4	1.7	6.1	1.5	5.7	6.8	-2.5	-2.7	3.4	10.2	4.7	-0.5	11.7	2.0	2.4	2.0	6.4	-1.1	5.4
<b>Apr</b>	<b>10.0</b>	<b>10.2</b>	<b>9.4</b>	<b>10.0</b>	<b>11.9</b>	<b>17.2</b>	<b>8.6</b>	<b>6.3</b>	<b>4.1</b>	<b>3.5</b>	<b>10.0</b>	<b>9.0</b>	<b>13.2</b>	<b>11.1</b>	<b>8.3</b>	<b>12.7</b>	<b>6.2</b>	<b>7.2</b>	<b>8.6</b>	<b>14.8</b>	<b>9.0</b>	<b>8.4</b>	<b>15.0</b>	<b>11.0</b>	<b>10.4</b>	<b>10.4</b>	<b>12.6</b>	<b>4.5</b>	<b>9.0</b>
7-9	8.6	8.6	8.2	7.8	9.5	16.6	7.2	5.8	3.4	2.6	8.7	7.1	12.2	9.4	8.0	11.8	4.9	5.6	7.2	14.3	8.4	6.9	14.3	8.7	8.9	8.7	10.3	3.9	8.3
9-16	12.8	13.1	11.9	13.0	14.5	19.9	11.7	8.3	6.4	5.8	12.8	11.9	16.4	14.5	10.4	15.8	9.0	10.3	11.4	17.4	11.4	11.3	17.6	14.6	13.5	13.7	15.9	6.8	11.5
16-21	12.2	12.7	11.3	12.4	13.5	18.6	11.1	7.4	5.8	5.4	12.1	11.8	15.1	14.0	9.4	14.6	8.5	10.1	10.9	16.1	10.4	10.8	15.8	14.2	12.8	13.1	15.7	5.9	10.5
21-23	9.1	9.4	8.7	8.0	10.3	16.3	7.9	5.5	3.5	3.0	9.1	8.5	12.2	10.3	7.5	12.1	5.7	6.7	7.9	13.9	8.2	7.7	13.8	9.0	9.5	9.6	11.7	3.7	8.1
23-7	6.6	6.7	6.5	7.0	9.6	14.4	5.0	4.1	1.4	0.6	6.7	5.4	9.6	7.0	6.2	9.3	2.8	3.4	5.3	12.2	6.5	4.8	12.6	7.0	6.8	6.4	8.5	1.9	6.3
<b>May</b>	<b>14.8</b>	<b>15.9</b>	<b>13.7</b>	<b>16.3</b>	<b>17.7</b>	<b>22.3</b>	<b>14.3</b>	<b>11.0</b>	<b>9.5</b>	<b>9.2</b>	<b>14.3</b>	<b>14.3</b>	<b>18.9</b>	<b>17.4</b>	<b>11.1</b>	<b>17.8</b>	<b>11.5</b>	<b>12.6</b>	<b>13.4</b>	<b>19.3</b>	<b>13.0</b>	<b>14.3</b>	<b>17.0</b>	<b>18.3</b>	<b>16.2</b>	<b>16.0</b>	<b>16.6</b>	<b>9.2</b>	<b>12.4</b>
7-9	13.8	14.8	12.9	14.6	15.1	22.2	13.3	10.8	9.1	8.7	13.4	12.9	18.3	16.2	10.9	17.3	10.6	11.6	12.3	19.0	12.8	13.3	16.9	16.0	15.3	14.8	14.8	9.1	11.9
9-16	17.9	19.2	16.3	19.5	20.1	24.7	17.6	13.1	11.7	11.5	17.3	17.5	22.6	20.9	13.2	21.1	14.5	15.9	16.4	21.9	15.5	17.6	20.1	21.9	19.7	20.0	20.1	11.8	15.0
16-21	17.2	18.7	15.8	18.7	19.3	23.5	17.1	12.2	11.2	11.2	16.8	17.5	21.0	20.3	12.3	19.7	13.9	15.6	16.1	20.6	14.5	17.0	17.9	21.2	18.9	19.2	20.0	10.8	14.2
21-23	14.2	15.2	13.3	13.8	16.3	21.4	13.8	10.3	9.0	8.7	13.8	14.3	17.9	16.9	10.5	17.5	11.1	12.5	13.0	18.7	12.2	13.8	15.0	16.3	15.3	15.6	16.2	8.3	11.7
23-7	11.0	11.7	10.3	13.0	15.5	19.7	10.2	8.6	6.8	6.2	10.6	9.9	14.7	13.0	8.6	14.0	7.5	8.3	9.6	16.3	10.2	10.2	14.2	14.5	11.8	11.0	11.9	6.1	9.2
<b>Jun</b>	<b>18.1</b>	<b>18.8</b>	<b>16.2</b>	<b>20.1</b>	<b>21.7</b>	<b>25.7</b>	<b>16.9</b>	<b>14.6</b>	<b>14.9</b>	<b>14.8</b>	<b>17.3</b>	<b>17.0</b>	<b>23.8</b>	<b>20.4</b>	<b>13.2</b>	<b>22.0</b>	<b>15.8</b>	<b>16.3</b>	<b>16.4</b>	<b>23.4</b>	<b>15.6</b>	<b>17.0</b>	<b>20.0</b>	<b>22.3</b>	<b>19.0</b>	<b>19.6</b>	<b>22.3</b>	<b>14.4</b>	<b>15.1</b>
7-9	17.2	17.8	15.6	18.3	18.8	25.8	16.0	14.5	14.7	14.6	16.5	15.6	23.3	19.3	13.2	21.5	15.4	15.4	15.4	23.1	15.6	16.2	20.0	20.2	18.2	18.4	20.0	14.4	14.6
9-16	21.1	21.9	18.8	23.5	23.6	28.1	19.9	16.6	17.0	17.0	20.4	19.7	27.8	23.7	15.3	25.2	18.5	19.1	19.4	25.9	17.9	19.8	23.7	25.8	22.2	23.5	26.4	16.8	17.7
16-21	20.6	21.4	18.3	22.8	23.3	27.1	19.6	15.9	16.5	16.6	19.9	19.9	26.1	23.4	14.6	23.9	18.0	18.8	19.1	24.7	16.9	19.4	21.2	25.1	21.6	22.8	26.8	16.1	17.1
21-23	17.7	18.2	15.9	17.5	20.8	24.9	16.6	13.9	14.1	14.2	16.8	17.1	22.9	20.1	12.5	21.8	15.5	16.2	16.3	22.9	14.7	16.6	17.4	20.5	18.3	19.0	22.2	13.5	14.5
23-7	14.3	14.8	12.9	16.5	19.9	22.8	13.0	12.2	12.2	12.0	13.3	13.0	19.2	16.1	10.8	18.2	12.3	12.4	12.4	20.5	12.9	13.3	16.7	18.5	14.9	14.5	16.5	11.6	11.9

AVERAGE EU BUILDING HEAT LOAD FOR HVAC EQUIPMENT

Table 2b . Outdoor temperatures EU-28, split-up in 5 time-periods per average month-day July-December, in °C (VHK calculation on the basis of JRC PVGIS for country capital, extract 2014)

time of day	EU28	AT	BE	BU	CR	CY	CZ	DK	EE	FI	FR	DE	GR	HU	EI	IT	LT	LI	LU	MT	NL	PL	PO	RO	SK	SI	ES	SE	UK
<b>Jul</b>	<b>20.0</b>	<b>19.9</b>	<b>17.8</b>	<b>21.8</b>	<b>22.5</b>	<b>27.9</b>	<b>18.3</b>	<b>17.0</b>	<b>17.7</b>	<b>17.6</b>	<b>19.2</b>	<b>18.6</b>	<b>25.7</b>	<b>21.5</b>	<b>15.1</b>	<b>23.9</b>	<b>18.3</b>	<b>18.3</b>	<b>17.9</b>	<b>25.4</b>	<b>17.6</b>	<b>18.7</b>	<b>21.4</b>	<b>23.9</b>	<b>20.1</b>	<b>20.5</b>	<b>24.6</b>	<b>17.4</b>	<b>17.4</b>
7-9	18.9	18.9	17.1	19.9	19.9	27.8	17.3	16.8	17.5	16.9	18.0	17.3	25.3	20.3	15.0	23.0	17.6	17.4	16.7	25.2	17.4	17.9	21.6	21.7	19.2	19.2	21.9	17.2	16.7
9-16	23.1	23.1	20.5	25.5	24.9	30.4	21.4	19.1	20.0	19.7	22.2	21.5	30.1	24.8	17.3	27.1	21.1	21.3	20.8	28.2	19.9	21.7	25.8	27.6	23.4	24.3	28.7	19.7	20.0
16-21	22.7	22.7	20.1	24.8	24.2	29.4	20.9	18.5	19.4	19.7	22.1	21.8	28.4	24.6	16.6	26.0	20.6	20.9	20.6	27.0	19.0	21.2	22.8	27.0	22.9	23.8	29.5	19.2	19.6
21-23	19.7	19.4	17.5	19.0	21.1	27.3	18.0	16.3	17.1	17.4	19.1	18.8	24.8	21.4	14.4	23.7	18.0	18.2	17.8	24.9	16.9	18.4	18.3	21.7	19.5	20.3	24.7	16.8	17.0
23-7	16.0	15.6	14.3	18.0	20.4	25.0	14.2	14.4	15.0	14.7	15.0	14.5	20.5	17.0	12.5	19.9	14.5	14.3	13.9	22.1	14.9	14.8	17.5	19.8	15.7	15.5	18.4	14.6	13.9
<b>Aug</b>	<b>20.1</b>	<b>20.0</b>	<b>18.4</b>	<b>21.1</b>	<b>21.6</b>	<b>27.7</b>	<b>18.6</b>	<b>17.6</b>	<b>16.7</b>	<b>16.3</b>	<b>19.8</b>	<b>18.8</b>	<b>24.9</b>	<b>21.1</b>	<b>15.5</b>	<b>24.0</b>	<b>17.1</b>	<b>16.9</b>	<b>18.4</b>	<b>25.8</b>	<b>18.1</b>	<b>18.1</b>	<b>22.0</b>	<b>22.7</b>	<b>20.3</b>	<b>20.6</b>	<b>24.2</b>	<b>17.4</b>	<b>17.9</b>
7-9	18.8	18.6	17.4	18.9	18.9	27.6	17.2	17.5	16.3	15.9	18.4	17.2	24.1	19.6	15.3	23.1	16.2	15.7	17.0	25.6	17.9	17.0	21.0	20.2	19.0	18.7	21.6	17.1	17.2
9-16	23.7	23.6	21.7	25.3	24.6	30.6	22.5	20.1	19.3	19.2	23.5	22.5	29.3	25.4	17.9	27.8	20.5	20.6	22.0	28.9	21.0	21.8	25.7	26.8	24.1	25.0	28.5	20.1	20.9
16-21	23.0	23.0	21.0	24.2	23.4	29.4	21.6	19.0	18.4	18.2	22.8	22.2	27.6	24.5	16.8	26.5	19.7	19.9	21.5	27.4	19.8	20.9	23.9	25.8	23.3	24.3	28.8	19.0	20.1
21-23	19.3	19.2	17.7	18.0	19.7	27.2	17.8	16.8	15.9	15.5	19.1	18.4	24.1	20.2	14.6	23.5	16.6	16.3	17.7	25.2	17.3	17.2	19.2	19.5	19.4	19.7	23.6	16.6	17.1
23-7	15.7	15.5	14.3	16.9	18.9	24.3	13.8	14.7	13.5	12.8	15.3	14.0	19.9	16.0	12.8	19.4	12.9	12.3	14.0	22.2	14.8	13.5	18.6	18.5	15.6	15.2	18.4	14.3	14.3
<b>Sep</b>	<b>15.5</b>	<b>14.3</b>	<b>14.5</b>	<b>15.5</b>	<b>16.0</b>	<b>25.3</b>	<b>13.2</b>	<b>13.6</b>	<b>11.4</b>	<b>10.9</b>	<b>15.0</b>	<b>13.8</b>	<b>20.8</b>	<b>15.1</b>	<b>13.5</b>	<b>19.6</b>	<b>11.5</b>	<b>11.1</b>	<b>13.4</b>	<b>22.6</b>	<b>14.7</b>	<b>12.4</b>	<b>20.3</b>	<b>15.9</b>	<b>14.5</b>	<b>14.7</b>	<b>19.3</b>	<b>12.4</b>	<b>14.8</b>
7-9	14.2	12.9	13.5	13.3	13.9	24.8	11.8	13.2	10.6	10.1	13.7	12.2	19.8	13.4	13.2	18.5	10.3	9.6	12.1	22.3	14.3	11.1	19.7	13.8	13.2	12.8	16.9	11.9	14.0
9-16	18.7	17.3	17.3	19.1	19.5	28.5	16.4	15.6	14.1	13.7	18.5	16.9	25.0	18.9	15.7	23.2	14.7	14.6	16.6	25.3	17.2	15.7	23.5	20.0	17.8	18.6	23.2	14.8	17.4
16-21	17.6	16.6	16.2	17.8	17.5	26.9	15.5	14.5	13.0	12.7	17.2	16.3	23.1	18.0	14.3	21.9	13.8	13.8	15.5	23.9	15.8	14.8	20.9	18.7	16.8	17.6	22.8	13.7	16.1
21-23	14.2	13.3	13.2	13.0	13.7	24.5	12.1	12.6	10.5	10.1	13.6	12.8	19.7	14.0	12.3	18.8	10.8	10.3	12.0	21.8	13.4	11.5	18.3	12.5	13.4	13.1	18.0	11.4	13.5
23-7	11.9	10.7	11.5	12.0	13.1	21.9	9.5	11.5	8.4	7.9	11.3	10.1	16.2	10.6	11.6	15.7	7.9	7.1	10.1	19.8	12.3	8.6	17.9	12.0	10.8	10.2	14.6	9.9	12.1
<b>Oct</b>	<b>11.8</b>	<b>10.3</b>	<b>11.2</b>	<b>10.4</b>	<b>11.7</b>	<b>21.6</b>	<b>9.3</b>	<b>9.4</b>	<b>6.6</b>	<b>6.0</b>	<b>12.0</b>	<b>9.7</b>	<b>16.9</b>	<b>10.7</b>	<b>11.3</b>	<b>16.8</b>	<b>6.8</b>	<b>6.5</b>	<b>10.1</b>	<b>20.1</b>	<b>11.3</b>	<b>8.2</b>	<b>17.9</b>	<b>10.1</b>	<b>10.3</b>	<b>11.4</b>	<b>14.7</b>	<b>7.6</b>	<b>11.8</b>
7-9	10.2	8.6	10.0	8.4	10.0	20.2	7.9	8.8	5.8	5.2	10.4	8.1	15.4	8.4	10.6	15.1	5.7	5.1	8.6	19.2	10.4	6.6	16.7	8.1	8.7	9.5	12.2	6.8	10.8
9-16	14.0	12.4	12.9	14.4	15.0	25.5	11.2	10.6	7.8	7.2	14.1	11.6	20.3	13.8	12.5	19.6	8.3	8.2	11.9	22.3	12.7	10.3	20.0	14.4	12.6	14.1	17.9	8.7	13.5
16-21	13.2	11.8	12.2	13.0	13.0	23.0	10.6	9.9	7.2	6.6	13.3	11.2	18.6	12.9	11.6	18.4	7.8	7.7	11.3	20.9	12.0	9.6	18.7	13.0	11.8	13.3	17.0	8.1	12.6
21-23	11.2	9.9	10.9	7.0	9.5	20.7	9.0	9.1	6.4	5.8	11.6	9.4	16.1	10.2	10.9	16.1	6.5	6.2	9.8	19.5	11.0	7.8	17.3	6.5	9.9	10.9	14.2	7.4	11.4
23-7	9.5	8.0	9.5	6.5	9.1	17.9	7.3	8.3	5.4	4.9	9.9	7.7	13.5	7.5	10.3	13.8	5.3	4.6	8.2	17.9	10.0	5.9	15.9	6.0	8.0	8.6	11.3	6.5	10.3
<b>Nov</b>	<b>7.1</b>	<b>4.9</b>	<b>7.0</b>	<b>5.3</b>	<b>5.9</b>	<b>16.9</b>	<b>3.7</b>	<b>5.0</b>	<b>1.7</b>	<b>1.1</b>	<b>7.3</b>	<b>4.3</b>	<b>13.1</b>	<b>5.2</b>	<b>8.3</b>	<b>13.0</b>	<b>1.7</b>	<b>1.1</b>	<b>5.4</b>	<b>16.5</b>	<b>7.4</b>	<b>2.8</b>	<b>14.0</b>	<b>4.7</b>	<b>5.1</b>	<b>6.2</b>	<b>9.2</b>	<b>3.2</b>	<b>8.3</b>
7-9	5.9	3.7	5.9	3.8	4.8	14.5	2.8	4.7	1.4	0.8	6.1	3.2	11.5	3.7	7.5	11.3	1.2	0.6	4.3	15.7	6.6	2.0	12.8	3.2	4.1	4.7	6.9	2.9	7.2
9-16	8.3	5.9	7.8	8.1	8.1	20.9	4.6	5.4	1.9	1.4	8.4	5.1	15.4	6.7	9.1	14.5	2.2	1.7	6.2	18.0	8.1	3.7	15.6	7.6	6.3	7.8	11.4	3.6	9.2
16-21	8.1	5.8	7.8	7.1	6.7	18.7	4.4	5.2	1.8	1.2	8.2	5.1	14.4	6.3	8.9	14.4	2.0	1.5	6.2	17.3	8.0	3.3	14.8	6.7	5.8	7.3	11.0	3.4	9.2
21-23	7.0	4.9	7.0	3.0	4.3	16.3	3.7	4.9	1.7	1.1	7.4	4.4	12.8	5.2	8.3	13.1	1.7	1.1	5.4	16.0	7.4	2.8	13.5	2.5	5.1	6.1	9.2	3.2	8.4
23-7	5.8	3.8	6.0	2.5	4.1	13.0	2.8	4.7	1.4	0.8	6.1	3.3	10.7	3.7	7.5	11.2	1.3	0.6	4.4	15.2	6.6	2.0	12.5	2.0	3.9	4.5	6.7	2.9	7.3
<b>Dec</b>	<b>3.3</b>	<b>-0.4</b>	<b>3.7</b>	<b>-0.2</b>	<b>0.7</b>	<b>12.9</b>	<b>-0.6</b>	<b>1.4</b>	<b>-2.8</b>	<b>-3.6</b>	<b>4.7</b>	<b>0.2</b>	<b>9.4</b>	<b>-1.1</b>	<b>6.0</b>	<b>9.3</b>	<b>-3.3</b>	<b>-4.8</b>	<b>2.4</b>	<b>13.2</b>	<b>3.6</b>	<b>-2.6</b>	<b>11.2</b>	<b>-1.7</b>	<b>-0.6</b>	<b>1.2</b>	<b>6.2</b>	<b>-0.6</b>	<b>5.4</b>
7-9	2.4	-1.1	2.9	-1.1	-0.3	10.6	-1.1	1.2	-3.1	-4.2	3.9	-0.4	8.3	-2.1	5.5	7.7	-3.6	-5.5	1.7	12.5	3.1	-3.0	10.2	-2.6	-1.2	-0.2	3.8	-0.7	4.8
9-16	4.1	0.2	4.2	1.7	2.3	16.4	-0.1	1.6	-2.4	-3.3	5.3	0.7	11.0	-0.1	6.6	10.7	-2.8	-4.1	2.8	14.4	4.1	-2.0	12.6	0.2	0.1	2.3	7.8	-0.5	6.0
16-21	4.0	0.0	4.4	1.2	1.4	14.6	-0.3	1.5	-2.7	-3.4	5.5	0.7	10.2	-0.5	6.3	10.8	-3.1	-4.4	3.0	13.6	4.1	-2.3	12.1	-0.3	-0.2	2.3	8.2	-0.7	5.9
21-23	3.0	-0.5	3.7	-1.9	-0.5	11.9	-0.7	1.3	-3.1	-3.7	4.7	0.3	8.6	-1.3	5.5	9.1	-3.7	-5.2	2.5	12.2	3.5	-3.0	10.2	-3.5	-0.7	1.3	6.5	-0.7	5.1
23-7	2.3	-1.0	3.0	-2.0	-0.7	9.5	-1.1	1.2	-3.0	-3.8	4.0	-0.3	7.8	-2.1	5.5	7.6	-3.7	-5.3	1.8	12.2	3.1	-3.0	10.0	-3.5	-1.2	0.0	4.0	-0.7	4.8
<b>YEAR AVG</b>	<b>11.2</b>	<b>10.0</b>	<b>10.6</b>	<b>10.5</b>	<b>11.5</b>	<b>19.4</b>	<b>8.9</b>	<b>8.4</b>	<b>6.0</b>	<b>5.4</b>	<b>11.4</b>	<b>9.4</b>	<b>16.1</b>	<b>10.6</b>	<b>10.1</b>	<b>15.5</b>	<b>6.7</b>	<b>6.6</b>	<b>9.7</b>	<b>18.1</b>	<b>10.4</b>	<b>8.1</b>	<b>16.3</b>	<b>11.0</b>	<b>10.2</b>	<b>10.9</b>	<b>14.5</b>	<b>7.0</b>	<b>10.9</b>
<b>Oct-Apr</b>	<b>6.6</b>	4.5	6.7	4.5	5.5	14.8	3.6	3.9	0.3	-0.5	7.4	4.3	11.3	4.6	7.6	11.3	0.9	0.5											

For comparison: When taking an extended period September to May, the result is 5267 heating hours (out of a total of 6570) with strictly during these hours an average outdoor temperature of 6.3 °C. The average outdoor temperature over all hours in September to May is 8.5 °C. Considering the carry-over from the thermal mass of the building and considering that most heating hours in the months of September and May occur during the night-period, when most heating systems have a reduced set-temperature ('night setback'), the relevant outdoor temperature for space heating may well be in the middle (7.4 °C) and less suitable as an EU average.

### 3.2.2 Reference values in Ecodesign regulations

As mentioned in the previous paragraph, the EU reference climate was subject of the study in the preparatory studies because it is relevant for the performance of heat pumps and air conditioners.

Instead of using a fictitious average, the meteorological data of Strasbourg-France (average climate), Helsinki-Finland (colder climate) and Athens-Greece (warmer climate) were chosen<sup>25</sup>. The table below gives the relevant data.

**Table 3. Bin-tables in Commission Delegated Regulation 811/2013. (Central Heating Boilers)**

outdoor temperature bin	Climate conditions			outdoor temperature bin	Climate conditions		
	Average	Colder	Warmer		Average	Colder	Warmer
T [°C]	h/a	h/a	h/a	T [°C]	h/a	h/a	h/a
-30 to -23	0	0	0	-3	89	306	0
-22	0	1	0	-2	165	454	0
-21	0	6	0	-1	173	385	0
-20	0	13	0	0	240	490	0
-19	0	17	0	1	280	533	0
-18	0	19	0	2	320	380	3
-17	0	26	0	3	357	228	22
-16	0	39	0	4	356	261	63
-15	0	41	0	5	303	279	63
-14	0	35	0	6	330	229	175
-13	0	52	0	7	326	269	162
-12	0	37	0	8	348	233	259
-11	0	41	0	9	335	230	360
-10	1	43	0	10	315	243	428
-9	25	54	0	11	215	191	430
-8	23	90	0	12	169	146	503
-7	24	125	0	13	151	150	444
-6	27	169	0	14	105	97	384
-5	68	195	0	15	74	61	294
-4	91	278	0	<b>total hours</b>	<b>4910</b>	<b>6446</b>	<b>3590</b>
				<b>bin-hours</b>	<b>53706</b>	<b>93661</b>	<b>18701</b>
				<b>avg. bin [°C]</b>	<b>5.1</b>	<b>1.5</b>	<b>10.8</b>

Figure 1 (p. 20) shows the 3 locations and the temperature data graphically. For comparison, also US and Japanese data are shown.

Note that the total heating hours for the Strasbourg climate (4910h) is practically identical to what was found as an average in the previous paragraph (4917h). The average outdoor temperature, however, is 1.4 °C lower than the EU average (5.1 versus 6.5 °C).

<sup>25</sup> Data derived from IWECC files (International Weather for Energy Calculations), publicly available through Energy Plus. See [http://apps1.eere.energy.gov/buildings/energyplus/weatherdata\\_sources.cfm](http://apps1.eere.energy.gov/buildings/energyplus/weatherdata_sources.cfm)

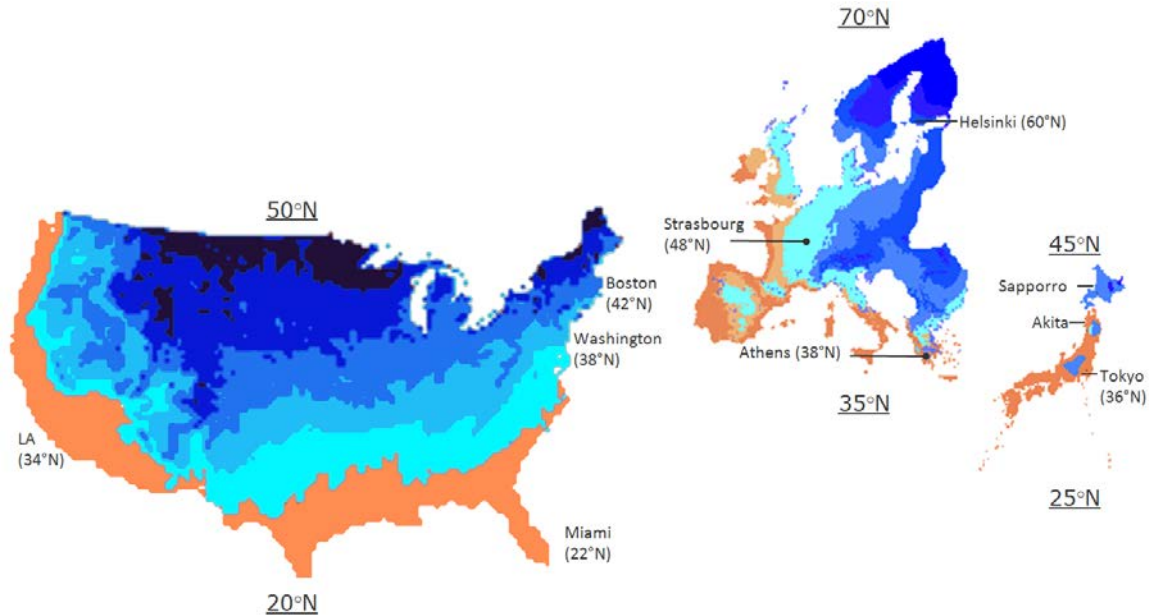

Figure 1. Comparison of winter climates US, EU, Japan; with degrees longitude (source: VHK, MEErP Part 2)

The table shows ‘bin-hours’, which is a sort of heating degree hours and the use of the tables in heat load calculations is known as the ‘bin-method’. A ‘bin’ is a rounded<sup>26</sup> outdoor temperature value, that is occurring during a number of hours over the heating season. The number of bin-hours is the multiplication of the difference between the bin-value and a reference temperature of 16 °C with the number of hours of the bin-value occurring over the heating season.<sup>27</sup> For the Strasbourg climate, with 4910 hours at an average outdoor temperature of 5.1 °C (difference 16-5.1=10.9) this results in 53 706 bin-hours.

The average bin-hours established from meteorological data in the previous paragraph, with 4917 hours at an average outdoor temperature of 6.5 °C (difference 16-6.5=9.5) amounts to 46711 bin-hours, i.e. 13% lower.

### 3.2.3 Eurostat heating degree days

Eurostat publishes climate data in the form of heating degree days (HDD). For 2009 Eurostat established 3076 HDD.

The text box shows the way the heating degree days are calculated, which is considerably different from the calculation of bin-hours.

<sup>26</sup> Integer= whole numbers = rounded without decimals, e.g. ‘10’ is anywhere between 9.5 and 10.5 °C.

<sup>27</sup> The resulting distribution of bin-hours is a measure of the distribution of the space heating load, i.e. between the 16 °C bin (zero heating) and the design temperature (maximum heating). The design temperature is the lowest outdoor temperature that the heating system still has to cope with, which is considerably lower than the lowest average temperature that is shown in Table 3. For the average climate the design temperature is -20 °C.

### Heating Degree Days (Eurostat)

Eurostat defined the following method for the calculation of heating degree days:

$(18\text{ °C} - T_m) \times d$  if  $T_m$  is lower than or equal to  $15\text{ °C}$  (heating threshold) and nil if  $T_m$  is higher than  $15\text{ °C}$ , where

$T_m$  is the mean  $(T_{min} + T_{max} / 2)$  outdoor temperature over a period of  $d$  days. Calculations are to be executed on a daily basis ( $d=1$ ), added up to a calendar month -and subsequently to a year- and published for each Member State separately.

The bin-hours, even if they are a sort of heating degree hours, cannot simply be transformed into Eurostat's *heating degree days* (HDD) through a division by 24. Eurostat uses a threshold temperature of  $15\text{ °C}$ , but after that the reference temperature is  $18\text{ °C}$  and not  $16\text{ °C}$ . Furthermore, Eurostat establishes an average day temperature from the mean of the minimum and maximum temperature in a day, instead of averaging the hourly values.

But the most important difference between the average climate bin-hours and the Eurostat average HDD is that the latter is a surface weighted-average of the heating degree days in the European Union's NUTS2-regions. In other words, the Eurostat HDD average is largely a geographical average that does not take into account the population density (~the density of the building stock), whereas the reference values from the preparatory studies in par. 3.2.1 relate to the most densely populated part of a Member State, i.e. the weather station closest to the capital, and then weight the temperature values per Member State data by population. Attempt was made to check whether the Eurostat HDD average could be consistent with the average meteorological data. Table 4 shows the result when the Eurostat heating degree days, at Member State level, are weighted for the population. The population-weighted average now becomes 2670 HDD.

**Table 4. Population weighted average heating degree days HDD for EU28, 2009 (VHK calculation on the basis of Eurostat database extract April 2014)**

EU28 Member State	HDD	population	EU28 Member State	HDD	population
Belgium	2 696	10 753 080	Luxembourg	2 967	493 500
Bulgaria	2 403	7 606 551	Hungary	2 594	10 030 975
Czech Republic	3 327	10 467 542	Malta	499	413 609
Denmark	3 235	5 511 451	Netherlands	2 727	16 485 787
Germany	3 063	82 002 356	Austria	3 301	8 355 260
Estonia	4 302	1 340 415	Poland	3 439	38 135 876
Ireland	2 841	4 450 030	Portugal	1 166	10 627 250
Greece	1 449	11 260 402	Romania	2 773	21 498 616
Spain	1 686	45 828 172	Slovakia	3 160	5 412 254
France	2 340	64 350 226	Slovenia	2 774	2 032 362
Croatia	2 316	4 435 056	Finland	5 596	5 326 314
Italy	1 829	60 045 068	Sweden	5 291	9 256 347
Cyprus	600	796 875	United Kingdom	2 990	61 595 284
Latvia	4 161	2 261 294	<b>Total</b>		<b>504 121 824</b>
Lithuania	3 931	3 349 872	<b>Weighted average</b>	<b>2670</b>	

In the Annex A the average Eurostat HDD was also recalculated at NUTS 2 level and the value further decreased to 2635 HDD (2009). Eurostat's HDD data are not available for the EU28 at a more detailed level than NUTS 2, but if they were, the number would probably decrease even more.

If the bin-hours are recalculated with a reference temperature of 18 °C instead of 16°C the temperature difference becomes 11.5 °C (18-6.5=11.5). Furthermore, considering that most people live in the more friendly climate zones of the country (near the sea, less in the mountains) this may account for another 1-2 °C structural difference. The temperature difference now becomes 13 °C (18-5=13). The resulting number of bin-hours is 63921 (4917 x 13) or 2663 'bin-days'. This is –given the other uncertainties of this approximate comparison-- close enough to the Eurostat value of 2670 HDD to claim consistency.

A preliminary conclusion is that the absolute average number of heating degree days calculated by Eurostat is not representative for the number of heating degree days experienced by the average EU building stock.<sup>28</sup> The Eurostat average (3076 HDD) is surface-weighted and at least 14% higher than a population-weighted average (2635 HDD).

In terms of the outdoor temperature for the average EU building this means that the actual temperature during the heating season, experienced by the EU building stock is at least 2.5 °C higher than the temperature that is apparent from the Eurostat data.

As far as outdoor temperature data are available, it seems that the population-weighted meteorological data per country capital city are currently the best choice. This assumption will be further explored in the next paragraph that is looking at local temperature differences and the influence of the urban heat island.

### *3.2.4 Local temperature differences and urban heat islands*

In the previous paragraph it was assumed that the outdoor temperatures of capital cities in the EU is a more accurate representation of the actual outdoor temperature for the average building than the 'geographical' NUTS 2 average temperatures used by Eurostat to define the heating degree days (HDD). In this paragraph that assumption will be discussed in more detail to describe the uncertainties of that choice in the light of specific local temperature characteristics. These characteristics relate for instance to the proximity to the sea, creating a relatively milder climate (warmer in winter, colder in summer), or in a mountainous area, creating a relatively colder climate throughout the year. A special case is the outdoor temperature in urban areas, where the Urban Heat Island (UHI) effect results in a considerably warmer climate –both in winter and in summer– than in the rural areas. The extend of the effect will be discussed, using the most recent literature findings.

---

<sup>28</sup> Note: The relative Eurostat data are valuable to indicate trends and –as absolute numbers– they are useful for surface-related impacts. The statement only refers to the use of average absolute HDD numbers in energy calculations for buildings.

### Coastal Regions

Eurostat defines ‘coastal regions’ as the NUTS 3 areas<sup>29</sup> where over 50% of the population is living less than 50 km from the sea. Some 23 out of 28 EU-Member States have coastlines and in 2008 approximately 41% of the EU population lived there<sup>30</sup>. Of these 205 million people, 36% live near the Mediterranean and 30% are situated near the North East Atlantic Coast. Of the EU capitals around 6 out of 10 are situated in a coastal region, with London, Athens and Rome being the largest. The exceptions include some very large cities like Paris, Berlin and Madrid, so in terms of the population (and buildings) in the capitals there is still only about 40-45% living near a coastline.

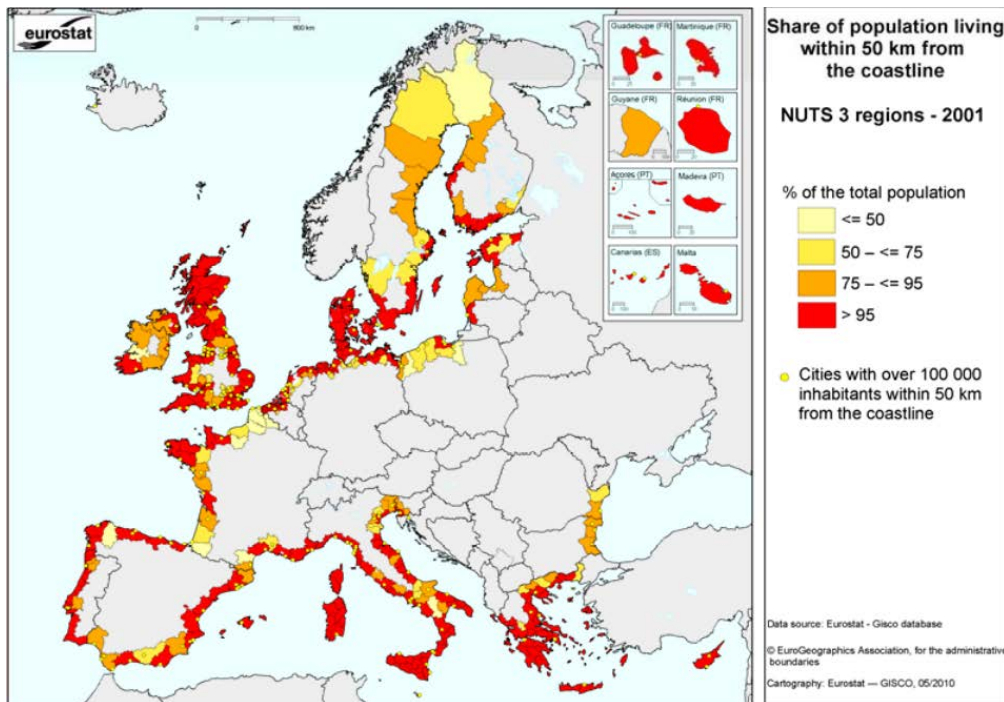

**Figure 2. Share of population living within 50 km from the coastline, NUTS 3, 2001 (Source: Eurostat, Statistics in Focus 38/2010)**

### Mountain regions

‘Mountain regions’ are defined not only by altitude but also by the slope within the boundaries of the NUTS 5 areas (municipalities).<sup>31</sup> In that sense it is found that the ‘mountain regions’ occupy 35.6% of the EU surface area<sup>32</sup> and are inhabited by 17.7% of the EU-population<sup>33</sup>. The Netherlands, the Baltic States and Malta have no mountains. The EU Member States with the highest mountain surface areas are Spain, Sweden and Italy. Around half of the 90 million EU mountain population lives near the Mediterranean or in otherwise mild climate zones (Portugal). This includes Italy (18 million), Spain (16 million), Greece (5 million), Portugal (almost 3 million) and a part of the French mountain

<sup>29</sup> NUTS 1: major socio-economic regions (e.g. country or region); NUTS 2: basic regions for the application of regional policies (e.g. province); NUTS 3: small regions for specific diagnoses (e.g. arrondissement). See also [http://epp.eurostat.ec.europa.eu/portal/page/portal/nuts\\_nomenclature/introduction](http://epp.eurostat.ec.europa.eu/portal/page/portal/nuts_nomenclature/introduction).

<sup>30</sup> Member States without a coastline are Czech Republic, Slovakia, Hungary, Austria, Luxemburg. Member States that wholly consist of ‘coastal regions’ are Denmark, Cyprus and Malta. In Germany only 9% of the population lives in a coastal region.

<sup>31</sup> NORDREGIO, Mountain Areas in Europe, European Commission contract, Final Report, Jan. 2004.

<sup>32</sup> 1 563 800 km<sup>2</sup> mountain municipality area on total 4 395 000 km<sup>2</sup> total EU-27 land area.

<sup>33</sup> 85.3 million people on a EU27 population of 480 million in 2000 (approx. 90 million on 503 million in 2011).



population (total 9 million). The harshest mountain climates can be found in Northern Europe but population density is low. EU capital cities with an elevation higher than or equal to 300 m include Madrid (667 m), Sophia (569 m), Luxembourg (305 m) and Ljubljana (300 m).

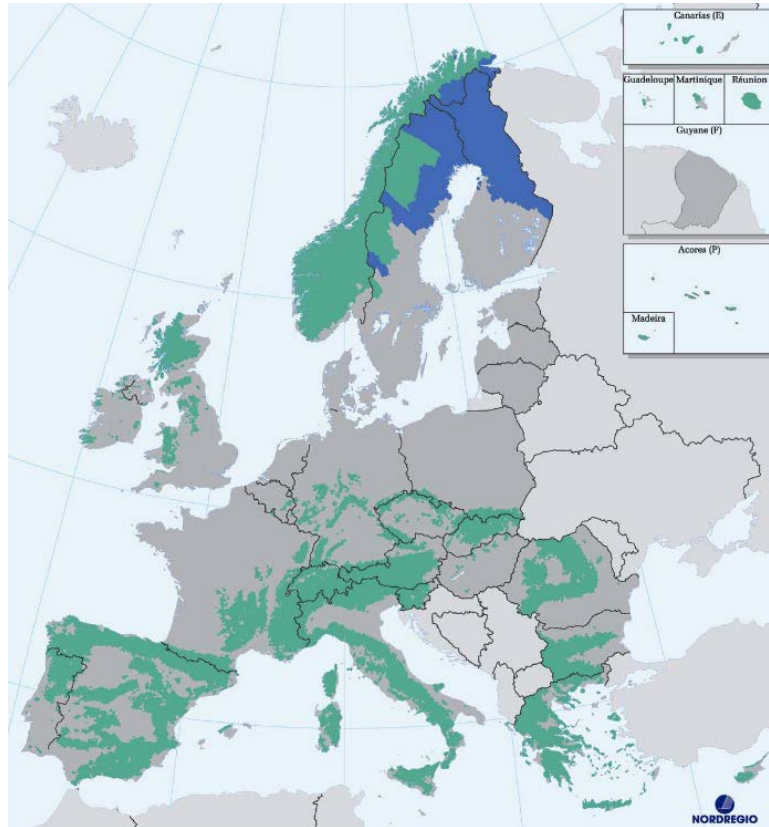
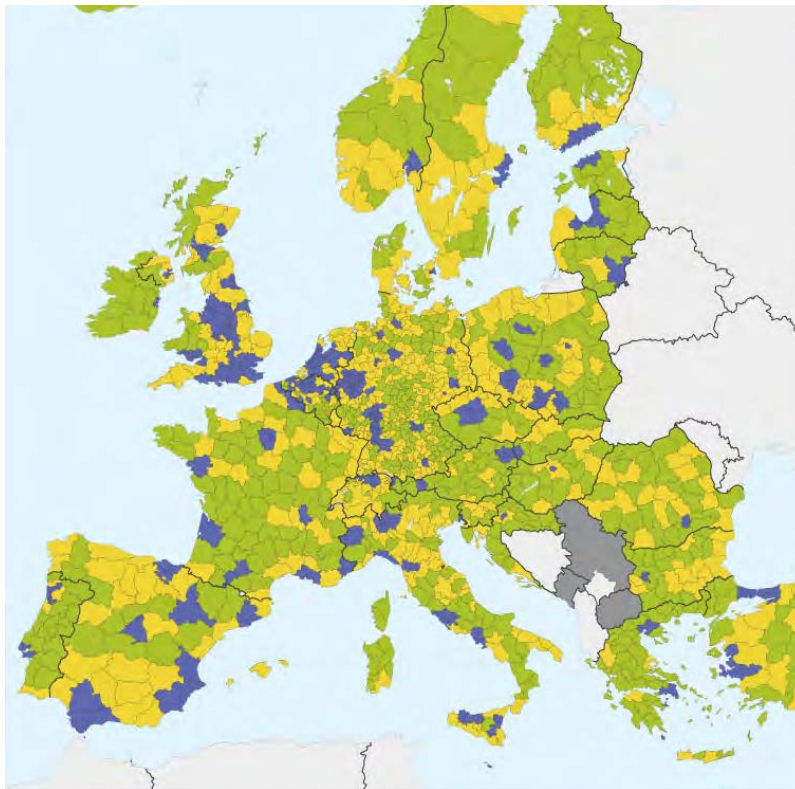

Figure 3 . Mountainous EU municipalities, because of climate conditions (blue) or topographic conditions (green), defined at NUTS 5 level. Source: NORDREGIO, 2004.

### **Urban-rural typology**

More than half (51.3 % in 2012) of the EU's land area and 112.1 million people (22.3% of total) are within regions classified as being predominantly rural. Just under two fifths (38.7 %) of the area and more than one third (35.3 %) of the EU's population are living in intermediate regions (towns, suburbs), while predominantly urban regions (around 900 cities) make up just 10.0 % of the land area but account for 42.4 % of the population.<sup>34</sup> Partitioning the intermediate region equally, over 60% of the EU population can be said to be living in urban areas. Considering that the average family size is on average some 10% lower in urban areas, it can be estimated that the number of primary dwellings in urban areas is even higher (over 65% of total primary dwelling stock).

<sup>34</sup> Source: Eurostat, Regional Yearbook, 2013. Analysis based on NUTS 3 definition (2010 classification)



**Figure 4. EU urban-rural typology by NUTS 3 region. Source: Eurostat, Regional Yearbook, 2013.**

- Predominantly urban regions (rural population: <20 % of the total population)
- Intermediate regions (rural population: 20–50 % of total population)
- Predominantly rural regions (rural population: >50 % of total population)
- Data not available

**A first inventory**

Table 5 (p. 25) gives selected geographic, demographic and regional typology characteristics of the EU capital cities and at the bottom line compares them to the EU averages discussed in the previous paragraphs. There is no pretention of ‘scientific proof’ but as regards the proximity to the sea (coastal regions), the table indicates that the average capital is fairly representative of the EU average. As regards the location in mountainous areas, it appears that on average more Europeans are living in the mountains than would be apparent from the data for average capital cities. Having said that, it must also be considered that there may some dispute as regards the definitions used in the statistics, i.e. also including certain lowland areas. Also the fact that large part of the mountain population is living in the Mediterranean area (Italy, Spain, Greece) may count for something if it were possible to construct a truly complete picture of the ‘average’.

**Table 5. EU Capital cities by position, altitude, population and type of region**

Capital	Latitude (deg)	Longitude (deg)	Altitude (m)	Population (000)	Coastal		Mountain	
					1=Yes	popu- lation	1=Yes	popu- lation
1 Wien, AT	48	16	188	1687	0	0	0	0
2 Bruxelles, BE	51	4	79	1159	0	0	0	0
3 Nicosia, CY	35	33	41	234	1	234	0	0
4 Prague, CZ	50	14	203	1246	0	0	0	0
5 København, DK	55	12	12	559	1	559	0	0
6 Tallinn, EE	59	25	0	407	1	407	0	0
7 Helsinki, FI	60	25	9	1033	1	1033	0	0
8 Paris, FR	49	2	46	6508	0	0	0	0
9 Berlin, DE	53	13	39	3501	0	0	0	0
10 Athina, GR	38	24	48	2989	1	2989	0	0
11 Budapest, HU	47	19	113	1727	0	0	0	0
12 Dublin, EI	53	-6	18	1261	1	1261	0	0
13 Roma, IT	42	12	28	2639	1	2639	0	0
14 Riga, LT	57	24	10	649	1	649	0	0
15 Vilnius, LI	55	25	204	533	0	0	0	0
16 Luxembourg, LU	50	6	305	90	0	0	1	90
17 Valletta, MT	35	14	71	203	1	203	0	0
18 Amsterdam, NL	52	5	10	1022	1	1022	0	0
19 Warszawa, PL	52	20	108	1715	0	0	0	0
20 Lisboa, PO	39	-9	13	1860	1	1860	0	0
21 Bratislava, SK	48	17	157	415	0	0	0	0
22 Ljubljana, SI	46	15	300	280	0	0	1	280
23 Madrid, ES	40	-4	667	3233	0	0	1	3233
24 Stockholm, SE	59	18	28	1580	1	1580	0	0
25 London, UK	51	0	17	8174	1	8174	0	0
26 Bucuresti, RO	44	26	88	1883	0	0	0	0
27 Sofia, BU	42	23	569	1208	0	0	1	1208
28 Zagreb, HR	45	16	122	1200	0	0	0	0
Average/Total Capitals			<b>124.75</b>	<b>48 995</b>	<b>13</b>	<b>22610</b>		<b>4811</b>
Share of total capital population						<b>46%</b>		<b>10%</b>
Share of total EU population						<b>41%</b>		<b>17%</b>

Source for population : Eurostat (online data code: urb\_cp0p1), population 1.1.2012 (relates to greater city where applicable)

Seemingly the most obvious drawback of using the outdoor temperature in capital cities to represent the EU average temperature for buildings is in the fact that they are all cities, whereas the statistics show that only around 65% of the EU buildings are in urban areas. But here it is important to consider that the outdoor temperatures of cities in JRC's PVGIS<sup>35</sup> and most building-related databases are measured not in the city centre, but in the most convenient places for weather stations. Typically this would be at airfields or other unobstructed places outside the city in suburban but mostly even rural areas. For instance, the temperatures for the city of Paris (France) in weather reports and long-term temperature time series (e.g. from Eurostat's heating degree days) come from the airport of Paris, Orly and not from the weather station at the Eiffel tower. Meteorologically there may be good reasons for that, e.g. to obtain measurements that are not disturbed by accidental local disturbances, but –as the next paragraph will explain– for the building physics it makes a significant difference which temperature is used.

### **Urban Heat Island**

A city constitutes a large thermal mass of roads, buildings and other infrastructure components, which capture the solar heat since sunrise and give off the heat during the evening and the night. The buildings are placed close together, shield each other from wind and reflect solar radiation not only outward but also on each other<sup>36</sup>. This makes average outdoor temperature in urban areas

<sup>35</sup> <http://re.jrc.ec.europa.eu/pvgis/>

<sup>36</sup> Compare: 'urban canyon' effect.

significantly higher than in the rural areas, especially in the evening and night, especially in Southern Europe and most pronounced in the middle of summer and winter.

Although the Urban Heat Island effect has been recognised for several decades, it has mostly been treated as a separate, undesirable side-effect of the growing urbanisation, leading to heat stress (thermal discomfort, also increased by the higher humidity) and higher air conditioning energy consumption in the summer. Proposed solutions include more trees and vegetation or, for those who can, fleeing the cities in the summer.

The positive effect of the UHI-effect on diminished space heating demand in the winter has hardly been addressed. Most national building codes and standards calculate the space heating requirements of buildings with the rural ('airport') temperature data.

For instance, Poli et al.<sup>37</sup> have looked into the test reference year data (TYR) that is used in dynamic energy demand simulation software used for the city of Milan (Italy) and have compared it with the real temperatures in the city. The traditional TYR data, e.g. from IWECC or IGDG<sup>38</sup>, are all based on observations by weather stations in the airports of Linate or Malpensa. They have compared it with temperature observations in the city centre, i.e. at Piazza Duomo, over a long period. The latter temperatures were 4 to 6 °C higher in the summer period June-August, but also in the winter period December to February.

Poli et al. calculated the effect on the space heating and cooling load of a typical building with a U-value of 1 W/m<sup>2</sup>.K and 20% glass façade. For the space heating the energy consumption with real TYR data was found to be 33% less than calculated with the traditional TYR. The space cooling energy, on the other hand, was found to be 30 to 40% more. With a better building insulation (lower U-value) the differences between models with the traditional and the real TYR data were found to be even higher.

The relative humidity (RH) in summer was about the same in both the new and traditional TYR – around 80%-- but this means that the absolute humidity was much higher than in the traditional TYR and the 'sensible temperature'<sup>39</sup> difference with rural areas could be as high as 9 °C.

Sobrino et al.<sup>40</sup> found similar values for the city of Madrid, but his focus was more on the UHI-effect over a day, where it was found that at noon –in the months of June and July-- there was practically no UHI effect. At night the UHI effect on the air temperature was strongest (4-6 °C) and in the morning the effect was 2.5 to 3 °C.

In the Northern part of Europe the UHI effect is also studied, again not from the angle of correcting national building codes but by meteorological institutes that want to determine which part of their data may be influenced by the UHI effect and which part comes from global warming.

---

<sup>37</sup> Poli, T. et al. (Politecnico di Milano BEST/ Osservatorio Meteorologico di Milano Duomo), *The influence of the urban heat island over building energy demand: The case of Milan*, paper at the 7th International Conference of Urban Climate, 29 June – 3 July 2009, Yokohama, Japan.

<sup>38</sup> IWECC International Weather for Energy Calculations; IGDG 'Gianni De Giorgio'

<sup>39</sup> The scientific name is the discomfort index (DI); this index estimates the effective temperature and describes the degree of discomfort at various combinations of temperature and humidity (Toy, Yilmaz, and Yilmaz 2007). DI is defined in terms of AT measured in degrees Celsius and relative humidity ( $f$ ):  $DI = AT - (0.55 - 0.0055f)(AT - 14.5)$ .

<sup>40</sup> Sobrino, J.A. et al. (University of Strasbourg, France), *Evaluation of the surface urban heat island effect in the city of Madrid by thermal remote sensing*, International Journal of Remote Sensing, 2013, Vol. 34, Nos. 9-10, pp. 3177-3192.

Cantat<sup>41</sup> finds that the city of Paris records a mean thermal positive anomaly of 3 °C during the night, which almost totally vanishes during the day.

Hamdi<sup>42</sup> of the Belgian Royal Meteorological Institute (KMI), estimated the UHI effect on the time series of Uccle (Brussels) between 1955 and 2005. He found that the UHI effect in 2005 was in the order of 1.7 °C (related to the minimum/night temperature) and that over the 50 year period it had been rising at a rate of 0.19 °C per 10 years.<sup>43</sup> These values are more modest than in Madrid or Milan, but if one considers that 1 °C temperature difference may save up to 10% in energy it is certainly not negligible.

In the Netherlands, the UHI effect was measured over a long time period between the small town of the De Bilt and the centre of the medium sized city of Utrecht (around 350 000 inhabitants)<sup>44</sup>. The temperature difference was found to be 1.5 °C at (minimum) night temperatures and 0.6 °C at (maximum) daytime temperatures.

Further North, e.g. in Stockholm and Hamburg, UHI effects of 1.2 °C on the minimum temperatures were found.<sup>45</sup>

At this point in time, only anecdotal data is available on the UHI-effect and we are still a long way from finding a statistically sound average value for the effect on the average EU building. However, on the basis of the anecdotal data the best possible estimate would be –according to the authors-- at least a 2 °C difference between the ‘official’ minimum outdoor temperature values for urban areas and the actual values, because of the UHI-effect. Assuming the buildings in urban areas to represent 65% of the total number of buildings, this would suggest a correction of 1.3 °C. However, it also has to be taken into account that the UHI-effect relates mainly to night-time temperatures and that a large part of the heating/cooling installations are subject to a night-setback regime between 23h at night and 7h in the morning. Therefore we assume only half of the UHI-effect will influence the average space heating/cooling load in the EU and the estimated UHI-correction should be in the order of 0.6 to 0.7 °C.

### **Outdoor temperature correction for products covered by regulation**

The Ecodesign (draft) regulations address most of the space heating and –cooling equipment, but not all equipment. District heating plants, direct use of geothermal heat, use of derived heat from large CHP installations or steam and large conventional boilers are not covered.

---

<sup>41</sup> Olivier Cantat, L'îlot de chaleur urbain parisien selon les types de temps - Weather types and Urban Heat Island in Paris, NOROIS revue, 2004/2, p. 75-102.

<sup>42</sup> Hamdi, Rafiq (Koninklijk Meteorologisch Instituut), *Estimating Urban Heat Island Effects on the Temperature Series of Uccle (Brussels, Belgium) Using Remote Sensing Data and a Land Surface Scheme*, Remote Sensing, 10.12.2010, 2, pp. 2773-2784.

<sup>43</sup> The maximum (afternoon) temperature UHI effect was 0.6 °C and had been rising at a rate of 0.06 °C per 10 years.

<sup>44</sup> Brandsma, T. and D. Wolters (KNMI), *Measurement and statistical modeling of the urban heat island of the city of Utrecht (the Netherlands)*, Journal of Applied Meteorology and Climatology, 2012, 51, 1046-1060, doi:http://dx.doi.org/10.1175/JAMC-D-11-0206.1.

<sup>45</sup> Richter, M. et al., *Observed Changes in Long-Term Climatic Conditions and Inner-Regional Differences in Urban Regions of the Baltic Sea Coast*, Atmospheric and Climate Sciences, 2013, 3, 165-176.

Most of these not (yet) covered products are fairly evenly distributed in the EU and there is no reason to assume a difference in the average outdoor temperature for products that are covered and those products that are not covered.

The exception is district heating. As already mentioned in par. 3.3.1, the countries with a cold climate tend to have a much higher share –between 40 and 60%-- of district heating than the rest of the EU. These are all Scandinavian Member States, the Baltic states, but also Eastern European countries.

Table 6 recalculates the bottom lines of the table 2b, which resulted previously in an EU average outdoor temperature of 6.6 °C, including district heating buildings. When excluding the district heating share (based on the residential share), the new EU average outdoor temperature of products in the Ecodesign scope is 7.0 °C.

**Table 6. Correction of the heating season average outdoor temperature for space heaters, excluding District Heating (DH)** [compare Table 2b.]

	EU28	AT	BE	BU	CR	CY	CZ	DK	EE	FI	FR	DE	GR	HU	EI	IT	LT	LI	LU	MT	NL	PL	PO	RO	SK	SI	ES	SE	UK	
Temperature incl. DH, in °C	6.6	4.5	6.7	4.5	5.5	14.8	3.6	3.9	0.3	-0.5	7.4	4.3	11.3	4.6	7.6	11.3	0.9	0.5	5.3	14.4	6.5	2.4	13.5	4.1	4.6	5.6	9.5	1.9	7.6	
Population share %	100	1.6	2.1	1.4	0.7	0.1	1.9	1.2	0.3	1.2	13.3	18.4	1.9	2.0	0.7	12.4	0.4	0.6	0.1	0.1	3.6	6.9	1.8	3.4	1.3	0.3	7.0	2.1	13.2	
DH share % *	13.4	19.3	0.2	15.7	7.9	0	36.9	58.1	49.9	49.4	6.8	14.1	0.8	14.8	0.1	1.9	53.7	57.3	0	0	4.1	52.8	0.0	17.6	40.9	14.2	0.0	40.5	2.1	
non-DH share %	86.6	1.3	2.1	1.1	0.6	0.1	1.2	0.5	0.1	0.6	12.4	15.8	1.9	1.7	0.7	12.2	0.2	0.3	0.1	0.1	3.5	3.3	1.8	2.8	0.8	0.3	7.0	1.2	12.9	
non-DH population %	100.0	1.5	2.5	1.3	0.7	0.1	1.4	0.6	0.2	0.7	14.3	18.2	2.2	2.0	0.8	14.0	0.2	0.3	0.1	0.1	4.0	3.8	2.1	3.2	0.9	0.3	8.1	1.4	14.9	
Temperature excl. DH, in °C	7.0	4.5	6.7	4.5	5.5	14.8	3.6	3.9	0.3	-0.5	7.4	4.3	11.3	4.6	7.6	11.3	0.9	0.5	5.3	14.4	6.5	2.4	13.5	4.1	4.6	5.6	9.5	1.9	7.6	
Correction in °C	0.4																													

\*= source: BRG Consult 2012, relating to share in residential dwellings

The resulting 0.4 °C correction is relevant when addressing the heat load for regulated equipment and it is relevant for verifying the accuracy of the space heating load in Chapter 6.

### 3.2.5 Global warming

Global warming could—according to the latest trends-- lead to outdoor temperature increases approximately 0.2 degrees per decade or more (see Figure 5). According to the latest EEA reports<sup>46</sup> the EU average is even higher, above 0.3 degrees per decade (Figure 6)

This is relevant for the long term trend (see Chapter 7) and/or could be used to updated older temperature time-series.

<sup>46</sup> EEA, Climate change, impacts and vulnerability in Europe 2012, European Environmental Agency, 2013

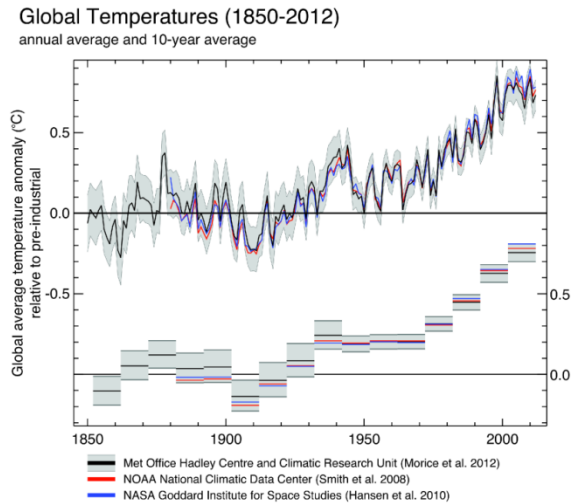

**Figure 5. Global average air temperature anomalies (1850 to 2012) in degrees Celsius (°C) relative to a pre-industrial baseline period (source: EEA, Copenhagen, extract June 2014)**

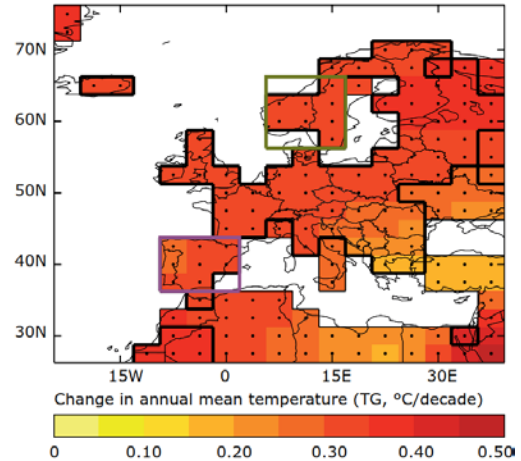

**Figure 6. EU average air temperature increase due to global warming (source: EEA, 2013)**

### 3.3 Indoor temperature

In building and equipment standards the assumed indoor temperature varies between 18 and 22 °C. Considering that this range represents a large (>30%) difference in energy consumption (c.p.), it is worthwhile to establish which one is likely to be correct.

Actual measurements with temperature loggers in a representative sample of dwellings are the most reliable source, but given that this type of information is scarce and certainly not available for all countries, also national building codes and equipment standards and results from Ecodesign preparatory studies will be taken into account.

#### 3.3.1 Building codes and –standards

In the context of the EPBD several EN standards were developed that deal with the calculated energy consumption for space heating of individual dwellings. These standards, like EN 13790 or the EN 15316, give calculation procedures but –when it comes down to providing temperature data–they refer to national building codes.

When looking at these national building codes the range varies indeed between 18 °C, which is the reference in the Netherlands EPG calculation taken into account intermittent heating (day- and night setback) and different temperature zones in the dwelling, up to 22 °C, which is the thermal comfort reference in Swedish houses without intermittent heating and differentiated temperature zones.

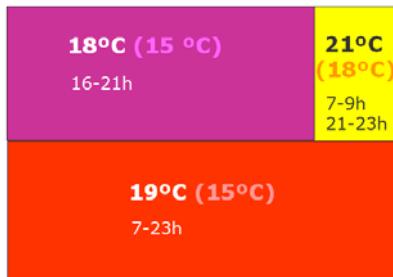

**Figure 7. Comfort and setback temperatures and time-periods in residential dwelling (VHK, ENER Lot 1, 2007)**

Note: For modelling purposes it is assumed that residential dwellings are constantly occupied, but not equally in all zones. The day-zone (living, kitchen, hall) is 50% of the heated floor area and occupied 16h/day (from 7 to 23h). The night-zone (bedrooms) is 40% of the heated floor area and actively used 5h/days (excl. sleep). The bathroom is used 4 h/day at two different periods (7-9h and 21-23h). The temperatures indicated in the graph are 1 K higher than those used in Lot 1. The surface- and time-weighted average is 17 °C without thermal inertia. With thermal inertia the average night-temperatures will be higher and thus the overall average temperature will be around 18 °C.

Overall, the Nordic countries tend to have higher averages indoor temperatures than the rest of the EU. Apart from the thermal comfort reference (SV 22 °C, FI 21 °C, DK 20 °C<sup>47</sup>) there is a relatively high share of heat pumps, where typically intermittent heating would not save much, and district heating, where differentiated temperature zones and intermittent heating are not common.

In Western European countries, not only in the Netherlands, the reference indoor temperatures are the lowest. The UK SAP calculates indoor temperatures as a function of, amongst others, the long term weather data (outdoor temperatures) and finds a mean heating season dwelling temperature of 18.2 °C, differentiated between 19.2 °C for the living room and 17.9 °C for the rest of the heated dwelling surface. In Germany, Austria and France the (minimum) comfort temperature is 19 °C, but depending on penalties for varying degrees of thermal discomfort<sup>48</sup> of the control system the reference indoor temperature can increase up to 21 °C. Differentiated temperature zones and intermittent heating are applied for modelling of individual cases (roughly as in EN 13790), but they are an extra bonus or penalty and not already incorporated in the reference temperature. For the simplest calculation procedures (e.g. in certification of existing houses) a fixed (20 °C) temperature is commonly used.

In Southern Europe (e.g. ES<sup>49</sup>, IT<sup>50</sup>, PO) the reference indoor temperature is 20 °C. Principles of EN 13790 apply for temperature zones and intermittent heating, but also here the impact is not incorporated in the reference temperature. In significant parts of these countries dwellings don't have central heating but rely on local heating (stoves, etc.), typically with high temperature in the room where they are placed (e.g. 20-22 °C) but low temperature (e.g. 8-10 °C) in e.g. bedrooms. Furthermore, in apartment buildings with centralised and block-heating a full night setback is applied<sup>51</sup>.

For Eastern Europe no data on reference indoor temperatures is available. It may be assumed, given the winter climate and the high share of district heating, that for urban areas it is similar to that of Nordic countries. For rural areas, also given the lower incomes, indoor temperatures will be closer to that of Western Europe.

<sup>47</sup> <http://www.sustainablebuildingscentre.org>

<sup>48</sup> The ideal situation being e.g. floor heating with constant temperature and no stratification. The worst case being an on-off heating with high temperature fluctuations (up to ±2 K) and high temperature stratification ('cold feet-hot head' phenomenon, vectors of up to 2 K).

<sup>49</sup> CTE DB HE1, 2009

<sup>50</sup> UNI/TS 11300-1:2008

<sup>51</sup> At least in Italy it is even mandatory.



All in all, the data do not allow for a quantitative assessment, but –when taking into account intermittent heating and temperature zones where appropriate– a mean EU heating season temperature of 19 °C for the heated surface of residential dwellings with central heating is plausible from this source. According to BRGC (preparatory study Lot 1, Task 2) around 20% of dwellings have no heating or only local heaters. Assuming, amongst others from the Ecodesign studies on local heaters, that most of these local heaters are in mild climates, an average mean heating season temperature of 14-15 °C is plausible. Weighting the total dwelling population for this fraction (20% local at 14.5 °C and 80% at 19 °C), the average EU indoor temperature would be around 18 °C.

As regards the non-residential sector the Italian EPB uses internal temperatures, which prescribes 20 °C for all types of residential and non-residential buildings, except for swimming pools and saunas (28 °C) and for sports buildings (18 °C). In Germany 20 °C is the reference for offices and schools, 22 °C for hospitals and public swimming pools, 18 °C for industrial and sports buildings and 16 °C for warehouses. Similar temperatures are used in the Netherlands, except for workplaces with severe physical work (industry, sports) a temperature of 13 °C is deemed enough.

In the UK, from the viewpoint of thermal comfort as a part of labour conditions, the UK Chartered Institute of Building Services Engineers (CIBSE)<sup>52</sup> recommends for (a) heavy work in factories 13 °C (b) light work in factories 16 °C (c) hospital wards and shops 18 °C (d) office and dining rooms 20 °C.

In France, the RT uses indoor comfort temperatures for health care establishments of 21 °C (high), for warehouse/industry/sports and transport buildings of 16 °C (reduced) and for all others 19 °C (medium). For setback periods less than 48h the setback temperature of high and medium temperature buildings is 3 degrees lower. For setback periods longer than 48h and for reduced temperature buildings the setback temperature in the heating season is 7 °C<sup>53</sup>. For hospitals and homes for elderly/handicapped the comfort temperatures are assumed to last 24/7 except for 8 hours during the daytime on weekdays (long), for canteens ('restauration pour un repas par jour') 5 hours per day for 5 days (short) and for all other types 10 hours a day for 5 weekdays. For schools extra holidays (53 days) are to be taken into account during the heating season (Oct.-April).

The result of these temperatures and times is e.g. for offices and shops an average indoor temperature of 15.4 °C<sup>54</sup>. For hospitals it is 20.4 °C and for warehouses around 13 °C.

On average the French temperatures are some 1-2 K lower than in other countries for which we have data, but they do have the advantage that –although most shops stay open for 6 rather than 5 days– they take into account setback temperatures and opening hours.

Although the investigation is not comprehensive, this source suggests that 21 °C for hospitals and swimming pools, 18 °C for shops, 17 °C for offices and schools, 16 °C for industry, 15 °C for sports buildings and 13 °C for warehouses are plausible mean heating season indoor temperatures in the EU.

---

<sup>52</sup> Source [www.hse.gov.uk](http://www.hse.gov.uk)

<sup>53</sup> But not lower than the outdoor temperature (it is a set-point 'température de consigne')

<sup>54</sup> Calculation author, with long setback temperature of 12 °C instead of the 7 °C minimum)

### 3.3.2 Measurements

In the UK, indoor temperatures were measured in a representative sample of UK households in the EFUS 2011 project (BRE 2012<sup>55</sup>). It revealed mean monthly temperatures for the whole dwelling range from 18.1 °C in December to 21.5 °C in July and August. The mean room temperatures recorded during the heating season (October to April) are 19.3 °C for the living room, 18.8 °C for the hallway and 18.9 °C for the bedroom, from which a mean temperature of 19.0 °C for the dwelling has been derived. This is 0.8 °C higher than the indoor temperature according to the SAP long term weather data mentioned earlier, but when the SAP data were recalculated with the weather data of the 2011 sampling period the differences were negligible. In other words and according to the researchers, the difference stems mainly from the difference in outdoor temperatures with 2011 being a warmer than average year.

The variations in mean heating season temperatures for different dwelling and household characteristics have been investigated.

- Dwellings that were fully double glazed, those with someone in during the day during a weekday, and those in which the occupants are not under-occupying have mean heating season temperatures that are significantly higher than other categories.
- Dwellings built pre-1919 have lower mean heating season temperatures than dwellings built between 1945 and 1990.
- Dwellings with a floor area <50m<sup>2</sup> have higher mean heating season temperatures than the largest dwellings with floor areas >140m.
- Owner occupied dwellings have lower mean heating season temperatures than rented dwellings (local authority or RSL).
- Dwellings with elderly people (>75 years) have higher temperatures than in the age group 45-64 years old.
- Dwellings with pensioners have higher temperatures than those without.
- Some groups of dwellings have significant differences in the mean heating season temperatures in one or other of the zones but not both.
- Flats have higher living room mean heating season temperatures than detached or semi-detached dwellings but no difference is seen between dwelling types for bedrooms.
- Dwellings in rural locations tend to have lower bedroom mean heating season temperatures than those in urban areas
- Dwellings in London tend to have higher bedroom mean heating season temperatures than dwellings in the North West and Yorkshire and Humber regions but no differences are seen between the living room mean heating season temperatures for either characteristic.

---

<sup>55</sup> Energy Follow-Up Survey 2011, Report 2: Mean household temperatures, Prepared by BRE on behalf of the Department of Energy and Climate Change, December 2013, BRE report number 283078

- Dwellings with no insulation measures have lower living room mean heating season temperatures than dwellings with at least one or more insulation measure, but no differences are seen in the bedroom mean heating season temperatures
- Households living in the dwelling typically have higher living room mean heating season temperatures than households without a pensioner present;
- Households with one or more persons retired have higher living room mean heating season temperatures than households with one or more persons working full time. No differences in the mean heating season temperatures in bedrooms/hall are seen for these groups.

BRE found that on average there was only a negligible difference between weekend and week days and suggested that this refinement was not needed in the SAP. The typical difference in living room versus bedroom mean temperature calculated in the models may be an over-estimate. Overall BRE found that measured averages were in line with SAP values.

BRE does not report of time-of-day temperature differences, but research in Leister in almost 300 dwellings suggested that also in Britain the temperature fluctuates within a 2 degree range, approximately between 17.5 °C and 19.5 °C (16.3 and 18.6 °C for semi-detached housing).

**Table 7. Mean indoor temperature for February 2010 measured in 292 dwellings.**

		Mean living room temperature (°C)				
		Whole day	Morning (7:00-9:00)	Day (9:00-7:00)	Evening (17:00-23:00)	Night (23:00-7:00)
All dwellings	(n=292)	18.4	17.5	18.2	19.4	18.1
Detached	(n=29)	17.6	16.3	17.2	18.6	17.1
Semi-detached	(n=130)	18.5	17.5	18.2	19.6	18.2
End terrace	(n=29)	18.2	17.6	18.2	19.5	18.2
Mid terrace	(n=70)	17.9	17.1	17.8	18.9	17.7
Flats	(n=34)	19.6	19.1	19.6	20.2	19.3

Source: T. Kane et al., VARIATION OF INDOOR TEMPERATURES AND HEATING PRACTICES IN UK DWELLINGS, Proceedings of the Research Students' Conference on "Buildings Don't Use Energy, People Do?" – Domestic Energy Use and CO2 Emissions in Existing Dwellings, 28 June 2011, Bath, UK

### 3.3.3 Fluctuation and stratification losses

In several building codes (e.g. Germany, France, UK) as well as in the EIA report there is an efficiency-penalty for the heating system due to fluctuation and stratification losses (a.k.a. 'control losses').

It refers to the inability of a heating system to reach the desired room temperature / thermal comfort in time and in space.

Fluctuation losses relate to the variation of the indoor temperature in time (F. *Variations temporelles*), where consumers tend to adjust the temperature setting of the heating system to a level where the minimum temperature equals the desired temperature. In other words, it results in a higher average indoor temperature than would be necessary with an ideal system.

Figure 8 illustrates this phenomenon by showing typical temperature lines for a low-efficiency on-off system, a high-efficiency modulation & timer system and the ideal temperature line.

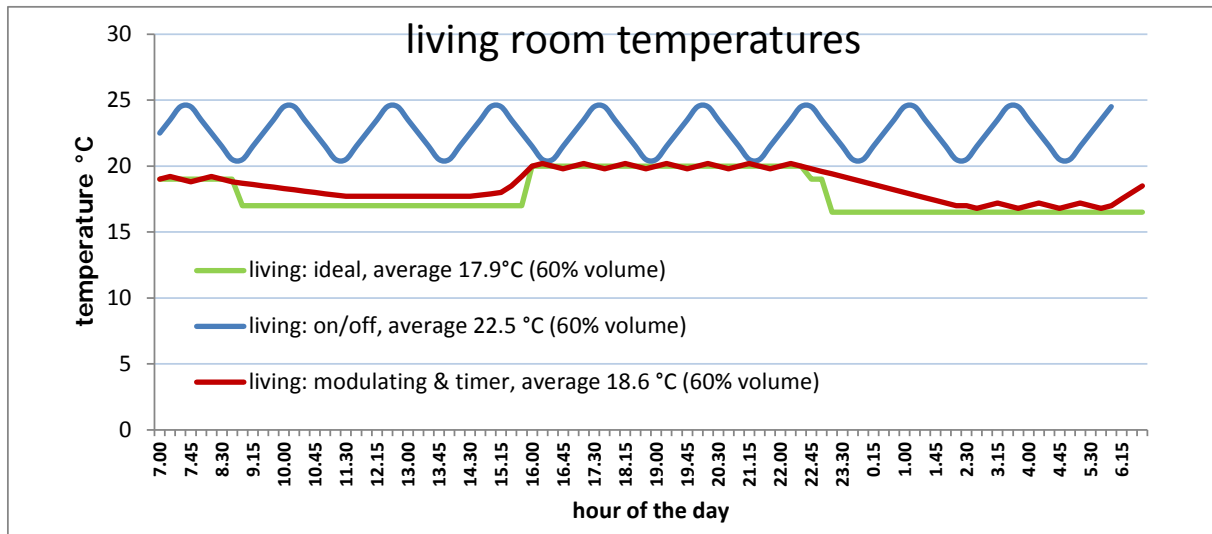

Figure 8. Typical indoor temperature lines for a low-efficiency on-off system, a high-efficiency modulation & timer system and the ideal temperature line. (illustrative)

These three lines represent the same level of thermal comfort, but the average indoor room temperature of the low-efficiency system is almost 4 °C higher than that of the high-efficiency system. In terms of energy consumption this means, depending e.g. on the reference climate, a difference of up to 40%.

Stratification losses relate to the variation of the temperature in the heated space (*F. variations spatiale*). The indoor temperature is not equally distributed in the heated space and rarely ideal for the best comfort. In the residential sector, with a low-efficiency heating system, there may be a difference of 2 °C between the floor level and the ceiling level, whereas with a high-efficiency system the difference may be less than 0.5 °C. The reaction of the average consumer to this 'cold feet-hot head' phenomenon is to try to avoid the 'cold feet' and thus raise the indoor temperature. This leads to an increase of the heat load and thus of the energy consumption.

It would be tempting to partition the fluctuation and stratification losses to the space heating load of the building, because in fact they increase the indoor temperature and thus the space heating load. But they are not caused by the building or by consumer preferences. They are a characteristic of the heating system and are not to be included in the modelling of the space heating load of the building.

However, it must be taken into account that when average indoor temperatures are measured in the buildings, they will be higher than the 18 °C that is proposed as a reference for the space heating load.

### 3.3.4 Internal gain

Internal gain is the space heating contribution of people, pets and energy-using product in the household. The preparatory study on boilers (lot 1) established that in most building regulations (DE, NL, UK) this contribution is set at 5 W/m<sup>2</sup> heated floor surface. With a heating season of around 5000 hours this results in 25 kWh/m<sup>2</sup>.year. The same study calculated that the 2003 average existing dwelling, on average built in 1965-1975, had a heated floor surface of 87 m<sup>2</sup>. In 2003 new dwellings this number was 103 m<sup>2</sup>. So, over approximately 35 years there was an increase of 16 m<sup>2</sup>, or rather 0.5 m<sup>2</sup>/year. These numbers will be revisited in the next chapter, but –for now—let us assume that in 2010 the average heated residential dwelling surface is around 90 m<sup>2</sup>. This would then result in an internal gain of (90 x 25=) 2250 kWh over the heating season.

Is this plausible? Most of the contribution will come from electric appliances, because a possible contribution of fossil fuel fired space heating devices is already taken into account in establishing their system efficiency.<sup>56</sup>

Eurostat established a final residential sector demand of electrical energy of 840 TWh in 2010 (EU-27). With around 200 million households this comes down to 4204 kWh per household (=ca. primary dwelling) per year. Considering that the average heating season is 7 months and the residential electricity consumption is higher in winter months, the electricity consumption in winter is then around 2600-2700 kWh per household. Around 22% of this electricity goes into space heating and should not be taken into account (i.e. effective contribution of radiation losses of the boiler are already taken into account in the heating efficiency calculation). This leaves around 2028 kWh per household.

How much of this 2028 kWh electricity is used to perform actual labour and how much is dissipated as waste heat?

Around 525 kWh is caused by electric water heating. The Lot 2 study estimates the primary energy efficiency of the average installed type at 27% for storage types and 33% for (hydraulic) instantaneous types. The theoretical maximum is 40% (at the given power generation efficiency), so around 25% of 525 kWh, i.e. 131 kWh/a, may be dissipated as heat. The question may be whether it is a useful contribution to space heating. A fraction of the storage water heaters may not be placed in the heated area of the house. So the effective contribution to space heating may not be more than 100 kWh/a. When considering also the fossil fuel fired water heaters and combi-boilers this amount will rise to around 300 kWh/a.

Lighting makes up around 500 kWh per year per household. It is considered a very effective contributor to space heating, because it is generated at the place and the time that people actually need space heat. The theoretical efficiency of lighting, i.e. the efficiency at which all electricity is used to generate light and there is no waste heat, is defined at 628 lm/W. Given the composition of the light sources in a 2010 EU household with still a majority share of incandescent and halogen bulbs (10-15 lm/W), 4 or 5 CFLs (30-60 lm/W) and 2 LFLs (60-80 lm/W), the average luminous efficacy is no more than 20 lm/W. This comes down to an efficiency of 3.2%, rather.e. 96.8% (around 480 kWh) is

---

<sup>56</sup> Note that the EN 13790 does take into account a part of losses from space heating systems as internal gain, but this is inconsistent with a correct and comprehensive calculation of the heating system efficiency and the EN 13790 approach is not followed here. Also the overall loss/gain correction factor (including thermal mass influence) of EN 13790 is not followed but instead with each contributor the relative space heating effectiveness is considered.

lighting waste heat that can contribute to space heating. With new light sources (LED) this number is expected to drop, but even at 100 lm/W average and no growth in lumen output the space heating contribution of lighting will still be around 85% of the input.

What goes for lighting, also goes for electronics (including displays): Around 85-90% of the input ends up as waste heat. In other words, of the 710 kWh that went into residential electronics in 2010 at least 600 kWh (85%) ended up as waste heat making an effective contribution to space heating.

Household refrigerators and freezers take up around 500 kWh of electricity. Assuming a 50% efficient compression cycle around 250 kWh ends up as waste heat and can be considered as a contribution to space heating.

Cooking appliances (hobs, ovens, etc.) consume around 385 kWh of electricity and 195 kWh of fossil fuels. The efficiency, e.g. in heating water, depends on the device and the energy sources and varies between 50 and 75%. Of the waste heat a significant part is immediately extracted by the range hood (hobs), but it may be assumed that some 20%, in total 100 kWh, is still useful.

The combined electricity consumption of all cleaning devices (washing machine, dishwasher, laundry drier, vacuum cleaner, etc.) is around 500 kWh. In the past they were considerable contributors to space heating but especially modern devices, the radiation losses of these devices are very limited and there is a question whether their position (laundry room) and operating time (e.g. dishwasher at night) are optimal to contribute to space heating. Therefore, it is assumed that only 100 kWh is useful.

Apart from the above devices, there will be a rest group of small hobby devices, electricity from ventilation units and other miscellaneous energy-using products. For this miscellaneous group around 100 kWh is taken into account.

Finally, apart from the waste heat of appliances there is the contribution of body heat. Assuming average clothing ( 1 CLO<sup>57</sup>) and low activity the average adult will dissipate heat of around 80 W. Given an average household of 2.4 persons (with pets compensating for the lower wattage of children), a dwelling occupancy of 14h/day (60%) gives 115 W. Over a heating season of 5000 h this gives 570 kWh of contribution to the space heating.

The sum of the internal gain contributions gives around 2500 kWh during the heating season for the average EU dwelling in 2010 (see figure 9). At an average dwelling surface of 90 m<sup>2</sup> and a heating season of 5000 h this results in 5.5 W, i.e. some 10% more than was assumed in most building standards. However, with increased efficiency of the devices, especially the electronics, 5 W/m<sup>2</sup> seems quite robust as a long term average.

---

<sup>57</sup> [http://www.engineeringtoolbox.com/metabolism-clothing-activity-d\\_117.html](http://www.engineeringtoolbox.com/metabolism-clothing-activity-d_117.html)

**Internal gain in heating season EU 2010  
[ in kWh per residential dwelling, total 2500 kWh]**

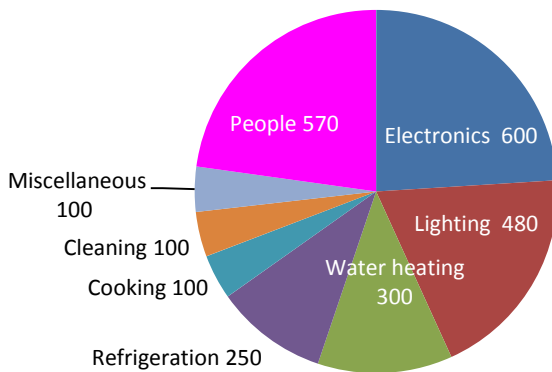

**Figure 9. Internal gain in heating season EU 2010, in kWh per residential dwelling, total 2500 kWh. (source: own estimate VHK on the basis of misc. sources)**

### 3.3.5 Solar gain

Solar gains is the useful solar heat entering buildings through windows ('direct solar gain') and, for a small part<sup>58</sup>, the sun heating the exterior (mainly roof) of the building.

The contribution of solar gains was addressed in Lot 1. The building regulations in the EU average climate use a default value that is slightly less than the internal gains, i.e. approximately 17-18 kWh per m<sup>2</sup> heated floor area over the heating season (ca. 5000 h/a, 208 days).

Another default value comes from the ongoing Lot 32 study on windows, which mentions that solar gains during the heating season account on average for a temperature difference of 1.2 K.

Ideally, the solar gains should be calculated according to EN 13790, but average EU input data for the complex calculation are lacking. Nonetheless an attempt is made to establish whether the default data above are at least plausible from a proxy of the EN 13790 calculation.

As a first step the average EU28 global solar irradiance (in W/m<sup>2</sup> or Wh/m<sup>2</sup>.d) was established for the heating season. This is shown in table 8, with a result of an average EU solar global radiance of 2610 Wh/m<sup>2</sup>.d for the heating season (Oct.-April), weighted for population. Note that this is for a horizontal plane oriented South.<sup>59</sup>

In order to establish how much of this solar irradiance could be useful, the EU monthly averages can be weighed against the heating load. This is shown in table 8 and results in 2259 Wh/m<sup>2</sup>.d.

<sup>58</sup> Usually only taken into account in building regulations for non-residential dwellings

<sup>59</sup> VHK calculation the basis of JRC-Ispra PVGIS (<http://re.jrc.ec.europa.eu/pvgis/apps4/pvest.php#>)

**Table 8 . Average EU28 global solar irradiance over the heating season, weighted for population and for heating load**

		Jan	Feb	Mar	Apr	Oct	Nov	Dec	AVERAGE
Space heating load	% of total	20%	20%	13%	6%	6%	16%	19%	
Global solar irradiance G, monthly EU averages weighted for population	Wh/m <sup>2</sup>	1608	2446	3478	4562	3040	1853	1281	2259

The values in the table are given for a horizontal plane with South orientation. The solar flux for a vertical plane would be 70% higher with South orientation, whereas the East/West orientation gives 35-40% less sun and the North orientation gives 70% less. Overall, assuming that on average there is no preference in orientation, the solar influx for windows should be 20% less than 2259 Wh/m<sup>2</sup>.d, i.e. around 1800 Wh/m<sup>2</sup>.d.

EN 13790 distinguishes reduction factors for shading of horizon, overhangs and fins. Depending on the position and orientation each of these factors vary between 0.7 and 0.95. Also for (lace) curtains there is a correction. Assuming around 0.9 for each of these four factors, the aggregated correction would be 0.65, which leaves around 1170 Wh/m<sup>2</sup>.d.

The most important inlet for solar heat contribution are transparent building elements, i.e. doors and windows. Considering that double glazing (without selective coating) as an average, the transparency factor is estimated at a g-value of 0.75. This leaves 877 Wh/m<sup>2</sup>.d.

Lot 32 mentions that on average the glazed window surface is around 6% of the heated floor surface, e.g. 6 m<sup>2</sup> for a 100 m<sup>2</sup> dwelling. This leaves 53 Wh/m<sup>2</sup>.d of solar contribution of the windows (note that the 'm<sup>2</sup>' now relates to the floor area of the dwelling). Given 208 days (5000 h) per heating season, this gives 11 kWh per m<sup>2</sup> of floor area over the heating season. This means that a contribution of 17-18 kWh/m<sup>2</sup> is too high for the heating season. If the average dwelling uses around 100 kWh/m<sup>2</sup> (including the effect of the solar gain), this means that the contribution of 1 to 1.2 K during the heating season is plausible, especially if the architects –as is in most manuals—prefer the South-West orientation over North-East for windows.



AVERAGE EU BUILDING HEAT LOAD FOR HVAC EQUIPMENT

**Table 9a. Global irradiance (W/m<sup>2</sup>) in EU-28, monthly total (Wh/m<sup>2</sup>.d)+ average (W/m<sup>2</sup>) split-up in 5 time-periods per average month-day, July-December** (VHK calculation on the basis of JRC PVGIS for country capital, extract 2014)

Month, time of day (unit)	EU-28	AT	BE	BU	CR	CY	CZ	DK	EE	FI	FR	DE	GR	HU	EI	IT	LT	LI	LU	MT	NL	PL	PO	RO	SK	SI	ES	SE	UK	EU28 W/m <sup>2</sup>
<b>Jan (Wh/m<sup>2</sup>.d)</b>	<b>1608</b>	<b>1458</b>	<b>954</b>	<b>2184</b>	<b>1754</b>	<b>3726</b>	<b>1210</b>	<b>805</b>	<b>563</b>	<b>538</b>	<b>1305</b>	<b>1068</b>	<b>3084</b>	<b>1526</b>	<b>1158</b>	<b>2645</b>	<b>676</b>	<b>829</b>	<b>1022</b>	<b>3235</b>	<b>971</b>	<b>974</b>	<b>3538</b>	<b>2074</b>	<b>1436</b>	<b>1952</b>	<b>3334</b>	<b>599</b>	<b>1234</b>	<b>67</b>
7-9 (W/m <sup>2</sup> )	58	49	29	73	52	203	41	19	4	3	47	30	77	53	30	116	13	16	34	146	28	27	170	78	46	74	154	5	35	
9-16 (W/m <sup>2</sup> )	210	193	128	280	232	458	160	110	79	76	172	144	409	201	157	338	93	114	135	412	131	131	445	261	191	255	423	84	166	
16-21 (W/m <sup>2</sup> )	4	2	1	15	5	23	1	0	0	0	2	0	14	3	0	9	0	0	1	12	0	0	16	17	2	4	14	0	0	
21-23 (W/m <sup>2</sup> )	0	0	0	0	0	0	0	0	0	0	0	0	0	0	0	0	0	0	0	0	0	0	0	0	0	0	0	0	0	
23-7 (W/m <sup>2</sup> )	0	0	0	1	0	0	0	0	0	0	0	0	0	0	0	0	0	0	0	0	0	0	0	0	1	0	0	0	0	
<b>Feb</b>	<b>2446</b>	<b>2305</b>	<b>2083</b>	<b>2958</b>	<b>3128</b>	<b>4369</b>	<b>2021</b>	<b>1734</b>	<b>1770</b>	<b>1809</b>	<b>2276</b>	<b>2074</b>	<b>3298</b>	<b>2432</b>	<b>1780</b>	<b>3160</b>	<b>1822</b>	<b>2061</b>	<b>2258</b>	<b>4029</b>	<b>2141</b>	<b>1926</b>	<b>3796</b>	<b>2822</b>	<b>2328</b>	<b>2700</b>	<b>3911</b>	<b>1644</b>	<b>2008</b>	<b>102</b>
7-9	123	114	101	141	128	263	104	87	74	124	113	102	82	120	82	177	81	100	112	224	108	92	217	129	115	135	219	72	95	
9-16	303	288	261	355	394	516	251	217	228	223	284	260	427	304	225	383	232	259	282	490	267	242	457	341	291	337	473	211	253	
16-21	15	12	10	38	23	41	12	9	5	0	12	10	28	13	8	24	7	9	12	28	11	9	31	35	13	14	30	4	10	
21-23	0	0	0	0	0	0	0	0	0	0	0	0	0	0	0	0	0	0	0	0	0	0	0	0	0	0	0	0	0	
23-7	0	0	0	0	0	3	0	0	0	0	0	0	1	0	0	1	0	0	0	1	0	0	1	0	0	0	1	0	0	
<b>Mar</b>	<b>3478</b>	<b>3398</b>	<b>2639</b>	<b>3917</b>	<b>3946</b>	<b>5200</b>	<b>3023</b>	<b>2642</b>	<b>2955</b>	<b>2980</b>	<b>3380</b>	<b>2848</b>	<b>4368</b>	<b>3579</b>	<b>2846</b>	<b>4504</b>	<b>3001</b>	<b>3257</b>	<b>2911</b>	<b>5185</b>	<b>2768</b>	<b>2989</b>	<b>5413</b>	<b>3541</b>	<b>3485</b>	<b>3535</b>	<b>5673</b>	<b>2833</b>	<b>2759</b>	<b>145</b>
7-9	211	236	164	228	216	328	187	171	182	185	213	173	153	221	176	277	187	209	178	318	173	182	326	198	216	218	352	177	167	
9-16	401	388	303	435	461	593	348	298	340	343	386	329	538	412	328	519	344	369	336	598	317	346	628	398	401	407	651	325	320	
16-21	41	29	31	76	57	64	35	35	34	35	41	32	52	41	33	52	36	42	33	59	33	34	60	64	41	41	67	34	31	
21-23	0	0	0	0	0	0	0	0	0	0	0	0	0	0	0	0	0	0	0	0	0	0	0	0	0	0	0	0	0	
23-7	5	9	4	5	0	9	5	5	5	5	6	4	5	6	5	7	5	6	4	8	5	4	8	5	6	6	9	5	4	
<b>Apr</b>	<b>4562</b>	<b>4519</b>	<b>3919</b>	<b>4971</b>	<b>4980</b>	<b>5805</b>	<b>4181</b>	<b>4382</b>	<b>4602</b>	<b>4597</b>	<b>4516</b>	<b>4159</b>	<b>5442</b>	<b>4779</b>	<b>4117</b>	<b>5385</b>	<b>4508</b>	<b>4388</b>	<b>4124</b>	<b>5973</b>	<b>4250</b>	<b>4118</b>	<b>5355</b>	<b>4573</b>	<b>4702</b>	<b>4444</b>	<b>5466</b>	<b>4368</b>	<b>4114</b>	<b>190</b>
7-9	297	295	258	300	283	357	277	291	301	302	305	276	284	309	271	345	299	298	272	373	283	269	347	269	308	292	359	287	270	
9-16	490	488	418	519	546	656	445	461	486	484	476	441	626	519	437	594	475	454	441	670	449	441	588	481	506	479	596	461	440	
16-21	79	75	69	116	93	76	74	81	84	85	83	75	80	77	74	81	83	86	72	82	77	71	81	101	79	74	86	80	71	
21-23	0	0	0	0	9	0	0	0	0	0	0	0	0	0	0	0	0	0	0	0	0	0	0	0	0	0	0	0	0	
23-7	18	17	17	20	14	14	18	21	22	23	20	19	12	18	19	17	22	23	17	16	19	17	17	20	18	17	18	21	17	
<b>May</b>	<b>5268</b>	<b>5132</b>	<b>4592</b>	<b>5769</b>	<b>5881</b>	<b>6055</b>	<b>4950</b>	<b>5398</b>	<b>5695</b>	<b>5624</b>	<b>4762</b>	<b>5210</b>	<b>5945</b>	<b>5421</b>	<b>4878</b>	<b>5816</b>	<b>5723</b>	<b>5325</b>	<b>4693</b>	<b>6156</b>	<b>5002</b>	<b>5252</b>	<b>5896</b>	<b>5023</b>	<b>5272</b>	<b>4865</b>	<b>6274</b>	<b>5778</b>	<b>4711</b>	<b>220</b>
7-9	348	340	308	345	342	395	332	362	377	372	322	348	356	361	328	384	382	359	314	395	337	350	380	298	351	322	414	380	317	
9-16	535	526	459	574	614	652	497	531	562	551	476	522	656	556	481	612	567	523	472	667	496	528	635	495	538	502	666	576	466	
16-21	112	105	103	148	127	102	109	127	133	134	106	116	98	111	113	108	131	126	102	101	115	115	99	129	109	97	112	130	108	
21-23	0	0	0	0	18	0	0	0	0	0	0	0	0	0	0	0	0	0	0	0	0	0	0	0	0	0	0	0	0	
23-7	33	30	32	40	29	24	33	41	43	44	32	36	19	32	36	28	42	40	31	24	36	35	24	40	32	28	28	41	34	
<b>Jun</b>	<b>5288</b>	<b>5279</b>	<b>4490</b>	<b>5866</b>	<b>6488</b>	<b>6314</b>	<b>4771</b>	<b>5100</b>	<b>5853</b>	<b>5695</b>	<b>5111</b>	<b>4732</b>	<b>6422</b>	<b>5654</b>	<b>4670</b>	<b>6148</b>	<b>5703</b>	<b>5191</b>	<b>4782</b>	<b>6384</b>	<b>4752</b>	<b>4902</b>	<b>6259</b>	<b>5410</b>	<b>5427</b>	<b>5139</b>	<b>6651</b>	<b>5478</b>	<b>4699</b>	<b>220</b>
7-9	349	350	303	349	346	409	321	340	385	374	347	318	397	375	314	403	379	349	321	408	319	327	407	324	360	340	432	360	314	
9-16	521	528	429	566	617	677	460	476	553	532	492	447	702	569	439	641	539	484	464	686	450	472	664	517	543	519	706	515	453	
16-21	124	118	115	161	163	108	119	138	154	154	128	125	109	124	125	119	150	141	117	109	124	122	113	149	121	111	120	147	117	
21-23	0	0	0	0	62	0	0	0	0	3	0	0	0	0	0	0	0	0	0	0	0	0	0	0	0	0	0	0	0	
23-7	40	37	39	50	67	27	40	49	55	56	42	43	22	38	44	33	53	50	38	27	43	41	29	50	38	34	31	53	39	

AVERAGE EU BUILDING HEAT LOAD FOR HVAC EQUIPMENT

**Table 9b. Global irradiance (W/m<sup>2</sup>) in EU-28, monthly total (Wh/m<sup>2</sup>.d)+ average (W/m<sup>2</sup>) split-up in 5 time-periods per average month-day,July-December** (VHK calculation on the basis of JRC PVGIS for country capital, extract 2014)

Month, time of day (unit)	EU-28	AT	BE	BU	CR	CY	CZ	DK	EE	FI	FR	DE	GR	HU	EI	IT	LT	LI	LU	MT	NL	PL	PO	RO	SK	SI	ES	SE	UK	EU28 W/m <sup>2</sup>
<b>Jul (Wh/m<sup>2</sup>.d)</b>	<b>5534</b>	<b>5636</b>	<b>4829</b>	<b>5987</b>	<b>6191</b>	<b>6269</b>	<b>5051</b>	<b>5310</b>	<b>5793</b>	<b>5716</b>	<b>5502</b>	<b>5027</b>	<b>6443</b>	<b>6060</b>	<b>4774</b>	<b>6323</b>	<b>5563</b>	<b>5218</b>	<b>5265</b>	<b>6529</b>	<b>4913</b>	<b>5162</b>	<b>6545</b>	<b>5910</b>	<b>5704</b>	<b>5456</b>	<b>6907</b>	<b>5451</b>	<b>4850</b>	<b>231</b>
7-9 (W/m <sup>2</sup> )	362	371	323	359	348	397	339	352	382	323	370	336	379	398	320	411	371	351	350	412	329	342	420	335	373	354	445	359	322	
9-16 (W/m <sup>2</sup> )	559	576	476	607	652	685	499	516	559	552	546	491	714	624	461	670	533	500	528	712	478	512	706	577	587	568	744	525	481	
16-21 (W/m <sup>2</sup> )	121	117	113	156	133	99	117	129	144	184	125	121	106	122	119	114	141	132	116	104	119	118	110	144	116	106	116	137	111	
21-23 (W/m <sup>2</sup> )	0	0	0	0	18	0	0	0	0	3	0	0	0	0	0	0	0	0	0	0	0	0	0	0	0	0	0	0	0	
23-7 (W/m <sup>2</sup> )	37	35	36	30	29	23	37	43	49	35	39	40	20	35	40	30	48	45	36	25	39	38	27	60	34	30	29	47	35	
<b>Aug</b>	<b>5156</b>	<b>5046</b>	<b>4397</b>	<b>5950</b>	<b>5802</b>	<b>6218</b>	<b>4630</b>	<b>4624</b>	<b>4508</b>	<b>4356</b>	<b>5069</b>	<b>4676</b>	<b>6309</b>	<b>5491</b>	<b>3942</b>	<b>6051</b>	<b>4721</b>	<b>4684</b>	<b>4688</b>	<b>6414</b>	<b>4503</b>	<b>4836</b>	<b>6582</b>	<b>5557</b>	<b>5191</b>	<b>5303</b>	<b>6706</b>	<b>4431</b>	<b>4503</b>	<b>215</b>
7-9	331	325	291	349	325	390	306	306	299	289	341	311	342	354	262	381	315	315	309	407	296	314	320	330	336	347	423	292	296	
9-16	548	542	459	631	634	693	485	476	459	440	528	484	724	591	406	668	482	479	494	709	470	511	737	585	556	566	743	453	471	
16-21	94	86	84	135	109	88	87	94	95	94	98	92	90	93	80	91	98	97	87	95	86	88	142	128	90	92	98	92	85	
21-23	0	0	0	0	12	0	0	0	0	0	0	0	0	0	0	0	0	0	0	0	0	0	0	0	0	0	0	0	0	
23-7	23	21	23	20	18	18	23	27	28	29	26	26	13	23	23	20	29	28	23	20	24	23	9	20	22	23	21	27	23	
<b>Sep</b>	<b>4162</b>	<b>4150</b>	<b>3321</b>	<b>5305</b>	<b>4637</b>	<b>6005</b>	<b>3457</b>	<b>3378</b>	<b>3024</b>	<b>2878</b>	<b>4132</b>	<b>3485</b>	<b>5826</b>	<b>4618</b>	<b>3410</b>	<b>5347</b>	<b>3341</b>	<b>3198</b>	<b>3743</b>	<b>5801</b>	<b>3398</b>	<b>3384</b>	<b>6000</b>	<b>4781</b>	<b>4360</b>	<b>4244</b>	<b>5998</b>	<b>3312</b>	<b>3447</b>	<b>173</b>
7-9 W/m <sup>2</sup>	255	255	210	298	249	361	218	216	192	183	265	220	247	276	212	323	216	210	236	345	215	208	371	270	270	251	366	209	212	
9-16	472	473	372	589	535	694	388	376	337	320	461	391	707	532	385	615	370	351	421	673	381	384	684	529	495	491	688	370	391	
16-21	55	52	46	101	70	69	47	48	43	41	58	47	67	54	45	63	49	49	50	65	47	44	74	92	56	49	72	46	44	
21-23	0	0	0	0	3	0	0	0	0	0	0	0	0	0	0	0	0	0	0	0	0	0	0	0	0	0	0	0	0	
23-7	9	9	8	10	5	10	9	9	8	8	11	9	6	9	8	10	10	10	9	10	9	8	12	10	10	8	11	9	8	
<b>Oct</b>	<b>3040</b>	<b>2999</b>	<b>2344</b>	<b>4253</b>	<b>3318</b>	<b>5209</b>	<b>2689</b>	<b>2114</b>	<b>1651</b>	<b>1544</b>	<b>2906</b>	<b>2461</b>	<b>4190</b>	<b>3344</b>	<b>2262</b>	<b>4207</b>	<b>2014</b>	<b>2116</b>	<b>2422</b>	<b>4983</b>	<b>2271</b>	<b>2515</b>	<b>4961</b>	<b>3574</b>	<b>3186</b>	<b>3152</b>	<b>4679</b>	<b>1879</b>	<b>2417</b>	<b>127</b>
7-9	163	159	131	215	150	307	146	112	86	79	166	131	92	175	118	230	112	121	134	286	122	135	288	178	173	177	264	97	129	
9-16	369	367	283	497	408	617	327	259	204	191	349	301	543	410	278	509	246	255	294	597	277	307	590	419	387	380	562	233	296	
16-21	24	21	18	61	32	49	20	15	10	9	24	17	38	23	15	33	14	17	18	41	16	18	45	50	24	26	40	11	17	
21-23	0	0	0	0	0	0	0	0	0	0	0	0	0	0	0	0	0	0	0	0	0	0	0	0	0	0	0	0	0	
23-7	1	1	1	5	0	4	1	1	0	0	1	1	2	1	1	2	0	1	1	3	1	1	4	5	1	2	3	0	1	
<b>Nov</b>	<b>1853</b>	<b>1579</b>	<b>1357</b>	<b>2346</b>	<b>1984</b>	<b>4182</b>	<b>1155</b>	<b>1163</b>	<b>634</b>	<b>562</b>	<b>1802</b>	<b>1296</b>	<b>3029</b>	<b>1875</b>	<b>1378</b>	<b>2930</b>	<b>805</b>	<b>954</b>	<b>1504</b>	<b>3661</b>	<b>1314</b>	<b>1156</b>	<b>3544</b>	<b>2183</b>	<b>1601</b>	<b>2081</b>	<b>3391</b>	<b>892</b>	<b>1476</b>	<b>77</b>
7-9	73	62	48	86	49	226	48	36	13	10	66	45	60	77	44	134	24	33	58	181	48	41	204	82	80	88	160	20	48	
9-16	240	205	178	297	266	514	149	156	87	78	236	171	404	242	184	372	108	126	196	460	173	152	431	275	205	268	428	122	196	
16-21	6	4	2	19	5	27	3	0	0	0	4	2	17	5	1	12	0	1	4	17	2	2	24	17	1	6	16	0	2	
21-23	0	0	0	0	0	0	0	0	0	0	0	0	0	0	0	0	0	0	0	0	0	0	0	0	0	0	0	0	0	
23-7	0	0	0	0	0	0	0	0	0	0	0	0	0	0	0	0	0	0	0	0	0	0	0	0	1	0	0	0	0	
<b>Dec</b>	<b>1281</b>	<b>1069</b>	<b>758</b>	<b>1797</b>	<b>1428</b>	<b>3374</b>	<b>828</b>	<b>617</b>	<b>337</b>	<b>307</b>	<b>1048</b>	<b>770</b>	<b>2628</b>	<b>1157</b>	<b>854</b>	<b>2380</b>	<b>400</b>	<b>501</b>	<b>846</b>	<b>2983</b>	<b>742</b>	<b>675</b>	<b>3262</b>	<b>1615</b>	<b>1036</b>	<b>1434</b>	<b>2697</b>	<b>359</b>	<b>881</b>	<b>53</b>
7-9	40	31	18	51	29	166	24	9	0	0	30	16	45	33	17	99	3	6	22	134	15	14	165	51	28	49	113	0	17	
9-16	170	144	103	236	194	423	111	86	48	44	141	106	356	155	117	307	56	70	115	382	102	92	409	210	140	190	347	51	121	
16-21	2	0	0	8	3	16	0	0	0	0	0	0	10	1	0	7	0	0	0	9	0	0	14	9	0	1	8	0	0	
21-23	0	0	0	0	0	0	0	0	0	0	0	0	0	0	0	0	0	0	0	0	0	0	0	0	0	0	0	0	0	
23-7	0	0	0	0	0	0	0	0	0	0	0	0	0	0	0	0	0	0	0	0	0	0	0	0	0	0	0	0	0	
<b>AVG (Wh/m<sup>2</sup>.d)</b>	<b>3640</b>	<b>3547</b>	<b>2974</b>	<b>4275</b>	<b>4128</b>	<b>5227</b>	<b>3164</b>	<b>3105</b>	<b>3115</b>	<b>3050</b>	<b>3484</b>	<b>3150</b>	<b>4748</b>	<b>3828</b>	<b>3006</b>	<b>4575</b>	<b>3190</b>	<b>3143</b>	<b>3188</b>	<b>5111</b>	<b>3085</b>	<b>3157</b>	<b>5096</b>	<b>3922</b>	<b>3644</b>	<b>3692</b>	<b>5140</b>	<b>3085</b>	<b>3091</b>	<b>152</b>
<b>Oct-Apr</b>	<b>2610</b>	2475	2008	3203	2934	4552	2158	1922	1787	1762	2462	2096	3720	2670	2056	3602	1889	2015	2155	4293	2065	2050	4267	2912	2539	2757	4164	1796	2127	109
<b>May-Sep</b>	5082	5049	4326	5775	5800	6172	4572	4762	4974	4853	4915	4626	6189	5449	4335	5937	5010	4723	4634	6257	4513	4707	6256	5336	5191	5001	6507	4890	4442	212
	100%	1.6%	2.1%	1.4%	0.7%	0.1%	1.9%	1.2%	0.3%	1.2%	13.3%	18.4%	1.9%	2.0%	0.7%	12.4%	0.4%	0.6%	0.1%	0.1%	3.6%	6.9%	1.8%	3.4%	1.3%	0.3%	7.0%	2.1%	13.2%	100%

### 3.4 Conclusion on temperature difference

The table below summarizes the findings in this chapter. For the purpose of modelling the most important is the overall EU indoor/outdoor temperature difference (all)  $\Delta T$  of 7.5 °C.

For heat load calculations of the building stock excluding district heating, a value of  $\Delta T = 7$  °C is appropriate. These calculations are not further pursued in this report.

**Table 10. Outdoor and indoor temperatures for the average EU building stock, for average 7 month heating season (t =4910 h)**

<b>Outdoor Temperature</b>	<b>°C</b>	<b>Indoor Temperature</b>	<b>°C</b>
Surface-weighted average	~3.5-4	indoor 24h average	18
Population-density weighted average	6.5	correction solar gain	1.2
Correction for local effects (e.g. urban heat island)	0.6	correction internal gain	2.3
<b>Average EU building total</b>	<b>~7.0</b>	<b>Average EU building</b>	<b>14.5</b>
<b><i>Indoor/outdoor temperature difference (all) <math>\Delta T = 7.5</math> °C</i></b>			
<i>Correction for district heating (DH)</i>	<i>0.4</i>		
<i>Average EU building, excluding buildings heated by district heating</i>	<i>~7.5</i>		
<b><i>Indoor/outdoor temperature difference (excl. district heating) <math>\Delta T = 7</math> °C</i></b>			

## 4 VOLUMES AND SURFACES

### 4.1 Introduction

For the assessment of the space heating load the

- heated volume  $V$  [in  $m^3$ ] and
- shell surface  $S$  of the heated volume [in  $m^2$ ]

are required. In principle, only the EU totals are required. But if the EU total is built from average values for  $V$  and  $S$  then also

- the number of EU buildings, subdivided by typology,

is required.

Auxiliary parameters to arrive at that assessment include the

- SV ratio [in  $m^2/m^3$ ],
- heated floor area  $A$  [in  $m^2$ ],
- heated ground floor area [in  $m^2$ ] or
- floor/building height and number of floors.
- typical indoor temperature per building or building zone [in  $^{\circ}C$  for a fraction of %]

The typical indoor temperature is relevant because it may vary with the application, as mentioned in the previous chapter. The accounting units for heated volume and shell surface are thus not absolute ' $m^3$ ' or ' $m^2$ ' but ' $m^3$  of 18  $^{\circ}C$  indoor temperature equivalent' and ' $m^2$  of 18  $^{\circ}C$  indoor temperature equivalent'. Shorter notations are ' $m^3@18^{\circ}C$ ' and ' $m^2@18^{\circ}C$ '.

For the weighting of different spaces, the rounded average EU outdoor temperature of 6  $^{\circ}C$  is taken as the yardstick. For instance, a space with 12  $^{\circ}C$  indoor temperature is counted at 50%, e.g.  $100m^3@12^{\circ}C$  equals  $50m^3@18^{\circ}C$ .<sup>60</sup> A space with 22  $^{\circ}C$  indoor temperature, e.g. a hospital, is counted at 133%<sup>61</sup>.

As a result of the above, buildings and dwellings without an active heating system and vacant buildings are not taken into account. Vacant buildings make up some 16% of the office stock and around 8% of the other non-residential building stock. In the residential sector an estimated 6% of dwellings is vacant. More details are given in Annex D.

Also secondary residential dwellings (holiday and weekend homes), are not taken into account because when they are occupied and heated, the occupants leave behind their primary dwelling which is then assumed to be unoccupied and unheated. Secondary dwellings make up approximately 20% of the building stock. (see Annex D)

<sup>60</sup> Equation:  $(12-6)/(18-6)=0.5$  (50%).

<sup>61</sup> Equation:  $(22-6)/(18-6)=1.33$  (133%)

Apart from the above exclusions, the study team aims to take into account all heated building spaces. This also includes, unlike some studies in the field, heated industrial and agricultural buildings and the non-residential part of predominantly residential buildings such as shops, offices, bars and restaurants in the ground floor of apartment buildings. The agricultural buildings include farm houses, heated greenhouses and –where applicable (mainly for chickens and breeding facilities) – heating of accommodations for livestock.

For the geometrical boundaries of ‘heated space’ there is a myriad of national definitions that reflect the different historical and political backgrounds<sup>62</sup> in Member States.

The differences relate, amongst others, to

- inner or outer shell dimensions, i.e. excluding or including outer walls;
- minimum ceiling height for an area to be taken into account;
- small deviations from rectangular floor plan (e.g. bay windows);
- treatment of not actively heated ‘adjacent spaces’ (e.g. conservatory);
- half-heated spaces (e.g. cellars or garages at a reduced temperature);
- technical- and circulation spaces (boiler rooms, hallways, stairs, etc.);
- use of simplified calculations (e.g. surface derived from volume with a fixed multiplier).

These differences exist between Member States, but also within one Member State several calculation methods may be applicable. The table below shows the case of Germany, where the reference floor area (D. ‘Bezugsfläche’) of a 100 m<sup>2</sup> dwelling varies between 79 m<sup>2</sup> and 109 m<sup>2</sup>. As a result, the specific heating requirement varies between 83 and 115 kWh/(m<sup>2</sup>.a).

**Table 11. Comparison between definitions of floor area for a reference dwelling in Germany 2013.**

All surfaces in m <sup>2</sup>	Grundfläche (GF)	Habitable surface (WoFi) from				Useful area (NF) nach		Net floor area (NGF) nach		Building useful area EnEV
		Wohnflächenverordnung			Destatis*	DIN 277	EnEV	DIN 277	EnEV	
		100 % GF	50 % GF	25 % GF						
Living room	33	30	3		33	33	33			
Kitchen	14	13	1		14	14	14			
Bathroom	10	10			10	10	10			
Hallway	13	13			13	–	–			
Toilet	5	5			5	5	5			
Bedroom	17	15	2		17	17	17			
Terrace	8			8	8	8	–			
Total reference floor area	100	86	3	2	100	87	79	100	92	109
Deviation from Wohnflächenverordnung floor area					+10 %	-4 %	-13 %	+10 %	+1 %	+20 %
Specific heating requirement in kWh/(m <sup>2</sup> .a)		100			91	105	115	91	99	83
Deviation from Wohnflächenverordnung heating requirement					-9 %	+5 %	+15 %	-9 %	-1 %	-17 %

Source: Forschungsstelle für Energiewirtschaft (FfE), *Bewertung und Vergleich flächenspezifischer Größen--Auf die Definition kommt es an*, BWK Bd. 65 (2013) Nr. 5

\*=Statistisches Bundesamt.

<sup>62</sup> ‘political’ meaning for instance that a derived parameter like ‘kWh/(m<sup>2</sup>.a)’ for heated floor area may be used to set targets or minimum requirements. The value of this target not only depends on the energy consumption (kWh) but also on the heated floor area (m<sup>2</sup>). Using slight modifications of the calculation procedures for the heated floor area may help to achieve targets, even if the energy consumption (kWh) stays the same.

The terminology is in practice not harmonised<sup>63</sup>, also due to the fact that building dimensions and numbers are published in statistics for many purposes that are not energy-related (see next paragraph on data sources). Some examples are listed hereafter:

- **Habitable area** (D. *Wohnfläche WFL*, NL. *woonoppervlakte*), which is typically the sum of the interior floor area of living room, kitchen, bedrooms and bathroom plus possibly a part of adjacent spaces (attic, cellar, conservatory, etc.).
- **Useful floor area** (D. *Nutzfläche NF*, NL. *gebruiksoppervlakte*), which is slightly bigger than the habitable area because it takes into account more of those adjacent spaces. Both the habitable area and the useful floor area do not take into account the circulation area (hallway, stairs), technical spaces (e.g. boiler room), cellar (unless it is actively heated), floor areas with a height smaller than 1.5 or 1.8 m and, etc..
- **Net floor area** (D. *Netto Grundfläche NGF*, NL. *binnenvloeroppervlak*), which for instance is the basis of the German EnEV (DIN 18599-1), fully takes into account also spaces like cellars or utility rooms that are often not equipped with active heat emitters.
- **Heated floor surface area**, means a calculated value which fully counts the habitable or useful area and only –based on the average indoor temperature in winter and the floor height—a part of the secondary spaces. This is called the ‘*Energiebezugsfläche*’ (Austria, Switzerland), ‘*beschermd vloeroppervlak*’ (Flanders, Belgium), ‘*surface hors œuvre net*’ SOHN (France, until 2012) or simply the *floor area* (UK SAP, France after 2012 ‘*surface a plancher*’). In German residential buildings the ‘*Gebäudenutzfläche*’ is used, which may be derived from the heated volume, using a multiplier.
- **Gross floor area** (D. *Brutto Grundfläche BGF*, including walls, F. *surface hors œuvre brut SHOB*) is a parameter used typically to describe economic activity of the construction sector. The parameter can easily be mistaken as heated floor area. The *gross building volume* (D. *Brutto Rauminhalt BRI*, NL. *Gebouwwolume*), i.e. based on the gross floor area and building height, is popular in national statistics that monitor land use and urban development. These gross values include the dimensions of the walls (roof, floor for the volume), which may lead to a difference of 10% with the net floor area and 20% with the net volume.

The figure below gives an illustration of the definitions, based on the case of Germany.

---

<sup>63</sup> There is a CEN standard EN15221-6, but it is not (yet) commonly used

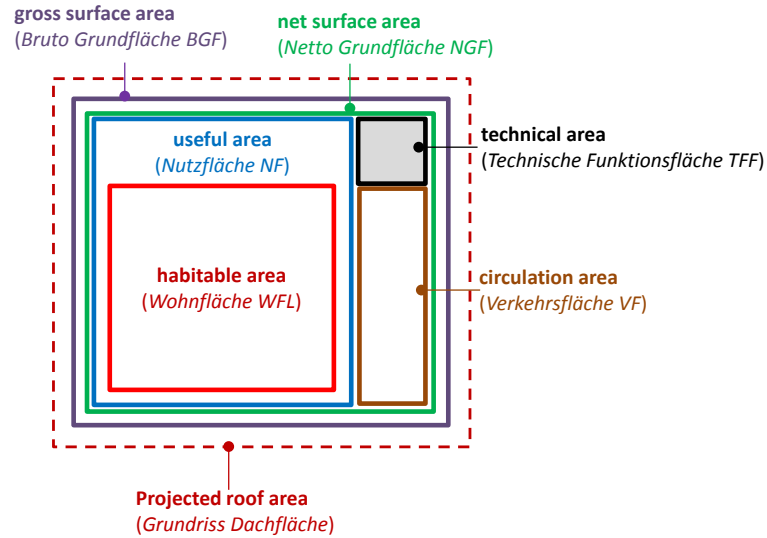

Figure 10. German definitions according to DIN277 for a single family dwelling (except for the projected roof area)

It is not within the scope of this study to solve the differences between the Member States. Also the harmonised EPB standards, like EN 13790, have not succeeded in solving these differences and leave the exact definition to the 'national level'.

In the context of this study, the authors will deal with the uncertainties on a pragmatic basis. But it is important to recognize that uncertainties in the order of magnitude of at least  $\pm 10\%$  for the building numbers and dimensions in the residential sector exist. For the non-residential sector, the uncertainties may even be higher, because there are large areas of technical and support areas (hallways, meeting rooms, technical areas) that many statistics do not take into account, and it may well be that on average the real heated volume is 50-100% larger than some statistics indicate.

The following tables 11 and 12 give further illustrations relating to the non-residential sector, e.g. on the official conversion factors between the various floor area definitions in Germany and on default values for the ratio of useful surface of the room versus the useful surface of the group in the *Réglémentation Thermique* in France.

**Table 12. Germany: Floor area conversion factors for non-residential buildings**

Number	Building category	Conversion factors floor area*			
		AHNF	ANF	ANGF	ABGF
1100	Parliament buildings	1.97	1.54	1.00	0.85
1200	Justice buildings	1.68	1.41	1.00	0.83
1300	Public administration buildings	1.71	1.40	1.00	0.85
1312	Public service buildings	1.64	1.38	1.00	0.84
1315	Tax offices	1.62	1.41	1.00	0.85
1320	Technical public buildings (e.g. lab)	1.75	1.33	1.00	0.86
1340	Police station	1.78	1.38	1.00	0.84
1342	Police main station	1.76	1.40	1.00	0.83
1350	Data centres	1.73	1.54	1.00	0.88
2000	Higher education buildings (e.g. university)	1.74	1.56	1.00	0.88
2100	Auditoria	1.91	1.64	1.00	0.88
2200	Institutes for research and education	1.70	1.54	1.00	0.89
2210	Higher education buildings I**	1.70	1.50	1.00	0.88
2220	Higher education buildings II	1.66	1.49	1.00	0.88
2230	Higher education buildings III	1.63	1.49	1.00	0.90
2240	Higher education buildings IV	1.67	1.53	1.00	0.88
2250	Higher education buildings V	1.94	1.75	1.00	0.89
2300	Research buildings (labs)	1.76	1.61	1.00	0.87
2400	Vocational higher education	1.76	1.61	1.00	0.87
3000	Health care buildings	1.78	1.53	1.00	0.86
3200	Hospitals and emergency clinics	2.01	1.72	1.00	0.86
4000	Schools	1.56	1.36	1.00	0.89
4100	Schools for general education	1.54	1.40	1.00	0.90
4200	Vocational schools	1.55	1.39	1.00	0.90
4300	Special schools	1.56	1.39	1.00	0.88
4400	Children day-care	1.60	1.30	1.00	0.86
4500	Vocational training centres	1.49	1.32	1.00	0.88
5000	Sports buildings	1.42	1.19	1.00	0.91
5100	Gymnasias (without pool)	1.40	1.17	1.00	0.91
5200	Swimming pools	1.72	1.40	1.00	0.88
6000	Communal homes	1.58	1.32	1.00	0.84
6300	Communal accommodation	1.69	1.36	1.00	0.85
6400	Care facility	1.53	1.29	1.00	0.85
6530	Canteens	1.64	1.46	1.00	0.91
7000	Industrial buildings & warehouses	1.41	1.16	1.00	0.89
7100	Agricultural building	1.20	1.14	1.00	0.90
7300	Workshops	1.28	1.16	1.00	0.91
7500	Warehouses	1.11	1.06	1.00	0.89
7700	Public voluntary services	1.53	1.14	1.00	0.87
7710	Road-works companies	1.44	1.14	1.00	0.86
7760	Fire brigades	1.48	1.15	1.00	0.86
8000	Technical buildings	1.95	1.24	1.00	0.85
9100	Cultural & music buildings	1.46	1.28	1.00	0.88
9120	Exposition buildings	1.46	1.34	1.00	0.87
9130	Libraries	1.42	1.33	1.00	0.90
9150	Assembly hall	1.47	1.25	1.00	0.88
9600	Prisons	1.66	1.45	1.00	0.84

Source: Bundesministerium für Verkehr, Bau und Stadtentwicklung, Bekanntmachung der Regeln für Energieverbrauchskennwerte und der Vergleichswerte im Nichtwohngebäudebestand, vom 30. Juli 2009

\*AHNF=Main useful area, ANF=useful area, ANGF=Net floor area, ABGF=Gross floor area

\*\*Categories of educational buildings



**Table 13. Réglementation Thermique 2012 (France): Default values for the ratio of useful surface of the room versus the useful surface of the group**

Functional group	Rooms specific for the functional group		Other rooms in the group						TOTAL
			reception/ circulation area	common toilets & wardrobes	common showers	standard offices	meeting rooms	technical serve rooms	
Residential	Dwelling	0.90	0.10						1.00
Offices	Standard office	0.60	0.267	0.033		0.10			1.00
Trade	Shops < 30 m <sup>2</sup>	0.40	0.28	0.00					1.00
	Shops > 30 m <sup>2</sup>	0.25							
Creche	Play area	0.30	0.15	0.10		0.15	0.10		1.00
	Resting area	0.20							
Primary school	Classroom	0.55	0.10	0.05		0.10	0.05		1.00
	Resting area	0.15							
Secondary school (daytime)	Classrooms	0.25	0.20	0.05		0.10	0.10		1.00
	Meeting rooms	0.15							
	Library	0.05							
	Teacher's room	0.05							
	Computer education area	0.05							
Secondary school (night)	Room (no kitchen, no bathroom)	0.60	0.20	0.10	0.10				1.00
University	Classrooms	0.35	0.20	0.05		0.10	0.05		1.00
	Meeting rooms	0.15							
	Library	0.05							
	Computer education area	0.50							
Public administrative building	Room (no kitchen, no bathroom)	0.50	0.20	0.10	0.10	0.10			1.00
Sports facility (all types)	Sports hall	0.75	0.05	0.10	0.10				1.00
Youth hostel	Room (no kitchen, no bathroom)	0.50	0.15	0.05	0.05	0.05	0.10		1.00
	Foyer	0.10							
Student home	Room (no kitchen, no bathroom)	0.60	0.15	0.10	0.10	0.05			1.00
Health care building (day)	Consultation and waiting rooms	0.25	0.25	0.05	0.05	0.20	0.15		1.00
	Production area	0.05							
Health care building (night)	Room (no kitchen, no bathroom)	0.20	0.15	0.05	0.05	0.15			1.00
	Offices and treatment rooms	0.20							
	Consultation and waiting rooms	0.15							
	Production area	0.05							
Hotel 0, 1*, 2* (day)	Breakfast area	0.40	0.431	0.051		0.116			1.00
Hotel 3, 4*, 5* (day)	Breakfast area	0.17	0.173	0.037		0.105	0.428		1.00
	Bar	0.09							
Hotel (night)	Room (no kitchen, no bathroom)	0.73	0.233	0.006				0.03	1.00
Industry (all hours)	Production area	0.60	0.10	0.05	0.05	0.10		0.10	1.00
Restaurant	Eating area	0.70						0.10	1.00
	Kitchen	0.20							
Tribunal	Justice court area	0.10	0.10	0.00		0.60		0.10	1.10
	Audience area (civilians)	0.10							
	Large hall	0.10							
	Holding cell	0.00							
Airport	Passenger area	0.42	0.179	0.105		0.143			1.000
	Shopping area	0.11							
	Customs area	0.04							

Source: RT 2012, Fiche d'application : Comment identifier l'usage d'un bâtiment et l'exigence associée ? Date Modification 24 Avril 2013.  
Table: ANNEXE 1 : Tableau des Ratel par défaut (ratio surface utile du local/surface utile du groupe)

## 4.2 Data sources

Accurate data on EU building numbers and geometry are not available from a single, consistent source. Hence, for the assessments in the next paragraphs the authors used a myriad of data sources.

Data sources for building dimensions include

- **GIS-based assessment of land coverage and usage** (e.g. LUCAS, previously CORINE), where the EU *built-up area*, as part of the *artificial land*, is estimated on the basis of the surface of roofed constructions (including greenhouses) as can be determined from satellite pictures, supplemented by surveyor assessments<sup>64</sup>. GIS-based systems are mainly used for environmental policy purposes (e.g. biodiversity). At the moment, the assessments for the built-up area use a resolution that is too crude for meaningful assessments (see Annex B).
- **Land registry** (NL. 'Kadaster'). This is a registration of the *floor area, geometry and usage of privately owned or public plots* within the territory of a commune. It is the input for national statistics on building permits and finished buildings, but the information is also used (and published) at local level. The published national statistics that are based on the land registry usually relate to the surface area and destination of the plot (including gardens, yards, etc.). The usual local context is urban planning or, more broader, land-use planning ('zoning'). The land registry does contain (some) information on the built-up surface area within the plots and the building height, but systematic national statistics are rare. One way to go around that omission is to use a typical ratio between the surface area of the total building site and the actual building area, but so far no studies were identified that actually went that route.
- **Statistics of building permits** and finished constructions. In terms of level of detail on building surface and –volume, the national statistics based on building permits are the most comprehensive. But, as mentioned in the introduction, the national statistics only single out a few parameters for publication. Furthermore, the statistics –even when considering long time series over the last 40-50 years—are not sufficient to capture the whole building stock, not only because they don't capture illegal building activities and construction activities that don't require permits, but also because they don't capture the buildings from an era where building permits did not exist or were less detailed.
- **Census** is the most comprehensive population-wide questionnaire in Member States, held by national statistics offices typically every 10 years. It is the most accurate source available for the number of households and thus the *number of primary dwellings*. Also several dwelling characteristics that are a measure of the living conditions, such as the *number of rooms*, *central heating system* (yes or no), *bathing facilities* (yes or no), etc. are being monitored in the Census. The Census does not include floor area or building volume data.
- **Monetary and real estate data.** All Member States know a tax for real-estate, which is typically based on the estimated worth of the property which in turn depends on position, floor area and usage. Likewise, in (national) production statistics for the non-residential sector the company's buildings are one known component of the invested capital. Finally,

<sup>64</sup> E.g. the satellite pictures of LUCAS are supplemented by field assessments by 750 surveyors that have to date investigated around 1 million data points.

commercial market research institutes for the real estate business gathers and publishes data for the state of the property values in the residential and non-residential sector. In principle, if an average price per m<sup>2</sup> floor area can be estimated, the monetary data can be used to estimate the total floor area. Some of the commercial institutes also develop height maps and floor counts of the properties<sup>65</sup>, which could be used to estimate the volume and shell surface of the buildings.

- **Urban planning guidelines** on the number and type of buildings/services (e.g. number of bakeries, doctors, etc. per capita). These guidelines may seem very useful in the beginning, but tend to be very different per country and even per location. Their usefulness is very limited.
- Estimation of non-residential building volume from **analogy with the better-known residential building** trends, based on key parameters (e.g. building volume per capita).
- **Architectural guidelines** indicating floor area and volume **per functional unit**, i.e. the number of hospital beds, tourist beds, employees, dwellings, etc.. Together with the number of functional units involved this allows an estimate of the total floor area and/or volume.
- **Economic Activity (NACE) statistics** and estimated average floor area per NACE unit. Every Member State publishes very detailed NACE-statistics that indicate the number of economic activity units (e.g. 'businesses') and the number of employees per unit. The big advantage of using NACE data is their high level of detail, which makes it easier to estimate typical floor area. From the NACE parameters, plus an estimate of the building volumes per unit and/or employee and/or functional unit, VHK performed a proprietary research, based on national NACE data, to estimate building volumes and ventilation rates in the non-residential sector.
- Architect data for **reference buildings** plus their estimated representation in the total population. In general, the estimated representation in the total population is very approximate and not very helpful in estimating the data for a country or EU total. However, the reference buildings are helpful in estimating other relevant characteristics such as the typical S/V ratio, i.e. the proportion of the shell surface to the volume of a specific type of building.
- **Reverse engineering from energy use and sales of heating systems** (if the number per building is known). At the moment, this approach is very much 'the cripple helping the blind' because –and this is the very reason for the study—the data on heating systems and their energy use are not much better than the data on the building size. But ultimately of course, they represent the two ends of the equation and have to match.

This list is not necessarily complete, but it represents the methods most commonly used. The German federal building ministry BMVBS<sup>66</sup> has looked into several methods to estimate the number and dimensions of the non-residential building stock for Germany. The main conclusion from this evaluation is that the indirect derivation from national statistics (land registry, building permits) is

<sup>65</sup> For instance <http://www.findmaps.co.uk>.

<sup>66</sup> Bundesministerium für Verkehr, Bau und Stadtentwicklung, 'Typologie und Bestand beheizter Nichtwohngebäude in Deutschland', BMVBS-Online-Publikation, Nr. 16/2011, Aug. 2011.

the most useful source, although at a limited aggregation level and subsequently with a considerable margin of error in floor area and volume. For more details see Annex B.

### 4.3 Secondary EU data sources

Secondary data sources are studies that have analysed the primary data sources and have drawn conclusions on the size (number, floor area, volume, etc.) of the EU building stock, often as an aggregate of national statistics and often as a part of a more comprehensive study of the building stock's energy consumption. These include studies that were performed in the context of the

- European Climate Change Programme (ECCP),
- Joint efforts of the national statistics offices,
- Energy Performance of Buildings directive (EPBD) and
- preparatory studies in the context of the Ecodesign (ED) and Energy Labelling (EL) directives.

#### 4.3.1 ECCP

Studies that played a role during the conception of the ECCP in 2001-2003 include the studies performed by the German branch of ECOFYS for insulation material manufacturer's association Euryma. These studies provided most necessary ingredients to estimate the building's energy consumption for the residential and the non-residential building sector. These studies used a three climate zones and a limited number of building categories for which the building dimensions and U-values were provided at EU scale. These data are incorporated in Part 2 of the 2011 MEERP methodology. They also played a role in the ANNEX 1 of the 2003 ECCP report, which gave a comprehensive overview of the CO<sub>2</sub>-emissions at building and product level<sup>67</sup> in 1990 and 2010 (the latter in a scenario with or without measures). Other data sources that played a role in the ECCP estimate were the outcomes of the PRIMES modelling (status 2001) and the anecdotal data of the ODYSSEE energy efficiency database.

#### 4.3.2 National statistics offices

Since the year 2000, a number of EU national statistics offices have been trying to put together –from national buildings data—European building statistics on the number and floor area of dwellings, characteristics of living conditions, etc.. A compilation of these data was also included in Part 2 of the 2011 MEERP methodology and it was one of the foundations of the Ecodesign Lot 1 preparatory study on the heat load for central heating boilers (VHK, 2006-2007).

#### 4.3.3 EPBD

In the context of the EPBD the European Commission has sponsored studies of national ministries and energy agencies as well as efforts of stakeholder groups (and their consultants) to get a better grip on EU building statistics that are relevant for the energy performance. These include projects such as ENTRANZE or EPISCOPE and TABULA<sup>68</sup>. The most recent information is available from the

<sup>67</sup> Instead of the sector level that was(en is) common in the PRIMES and POLES models at the time.

<sup>68</sup> See <http://episcope.eu/index.php?id=97>

BPIE ('Buildings under the microscope') and a study of Ecofys in the context of the Leonardo programme.

In terms of building numbers these last two studies are complementary. The BPIE study has a strong focus on residential dwellings and a tendency to underestimate the space heating effort in the non-residential sector. The Ecofys study deals exclusively with the non-residential sector.

#### 4.3.4 Ecodesign preparatory studies

Information on number and size of the EU building stock were retrieved and analysed from various sources in the Ecodesign preparatory and impact assessment studies on Lot 1 (Boilers, VHK 2007) and ENTR Lot 6 (Ventilation, VHK 2011 and Air conditioners, Armines 2011).

Especially for the non-residential sector reliable data were scarce and –e.g. for the Lot 1 study—had to be estimated on a handful of available national statistics aggregated to EU level. Nonetheless, the Lot study presented for the first time a detailed estimate of the total EU heated building volume.

The scarcity of data on non-residential buildings prompted VHK in 2008-2009 to perform a proprietary study based on NACE data in order to refine the estimate. Here the researchers did not use only Eurostat but went back to the more detailed national NACE statistics. A part of this comprehensive study (the EU totals) was brought in the public domain through the ENTR Lot 6 preparatory study on ventilation units. The information from ENTR Lot 6 was also included in the MEErP 2011, Part 2.

## 4.4 SV ratio

While at least some statistics on building volume can be found, there are no statistics on shell surface at all. The SV ratio, i.e. the ratio between the heated shell surface area  $S$  and heated building volume  $V$ , is thus an indispensable intermediate parameter in determining the shell surface area.

Two approaches to the SV ratio are found:

- The 'architectural approach', where the SV ratio is determined for individual dwellings, taking into account the differences between exterior and interior/adjacent walls/floors/ceilings or
- The 'urbanistic approach', which looks at the SV ratio of whole building blocks.

Although the former approach is the default in most building regulations, it requires statistical data on e.g. the number of top-/corner-/floor-/middle-apartments and dwellings that is simply not available. Therefore, the urbanistic approach is followed. This means that e.g. terraced dwellings are treated at the level of whole streets (on average 15 dwellings/street). Apartments blocks have an SV ratio, which is then considered the average per apartment. City blocks, often a neglected category of low-rise apartments, are also treated at the level of streets.

Figure 11 gives an illustration of the numbers that will be used in the subsequent estimates for the residential dwellings.

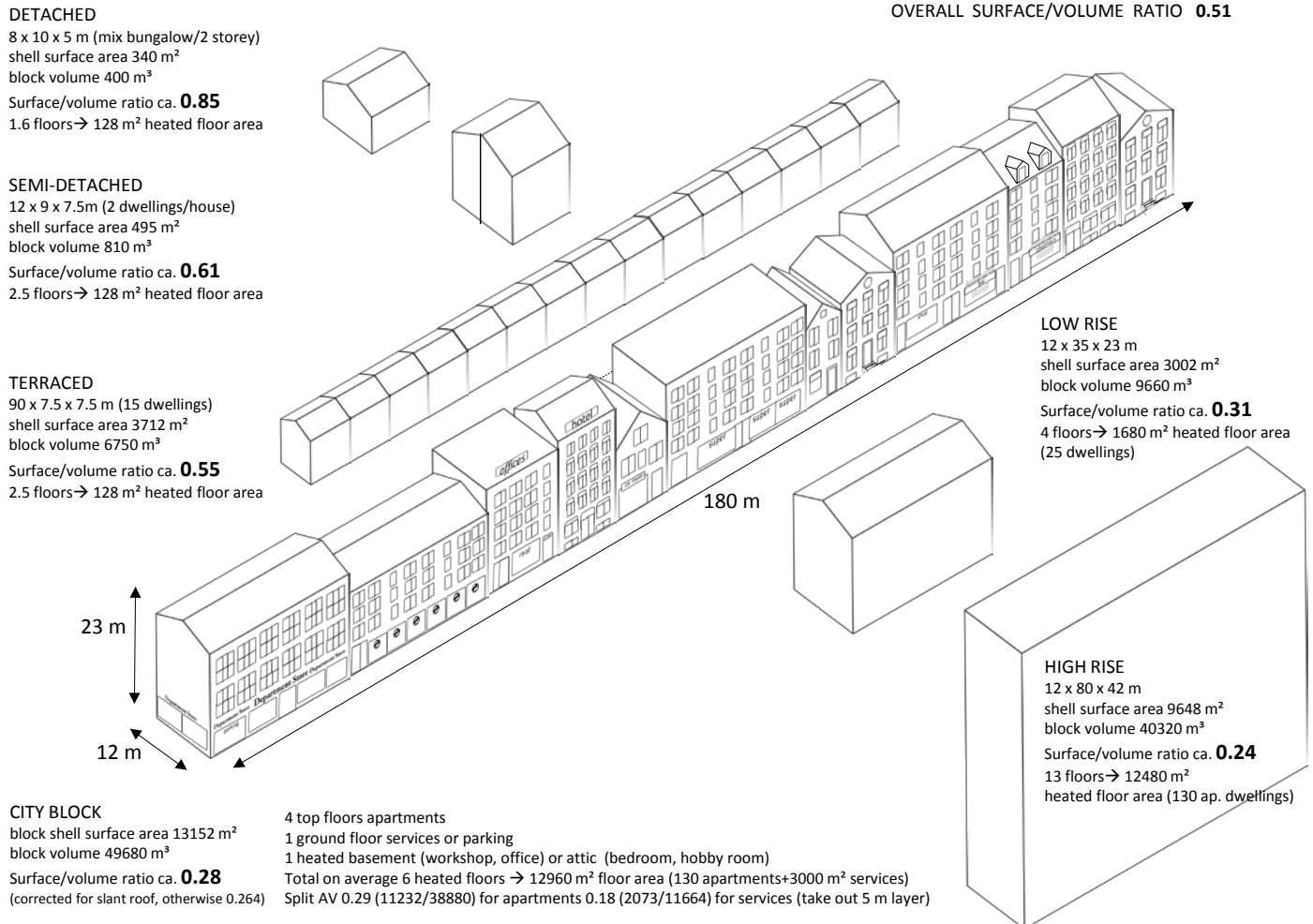

Figure 11. SV ratio of residential buildings (VHK 2014)

For non-residential dwellings the SV ratio of the reference buildings from ENTR Lot 6 are given. These are described in detail in the preparatory studies for ventilation units and air conditioners and there is also additional information on occupancy and ventilation rates. These data are also given in MEERP-2011, Part 2.

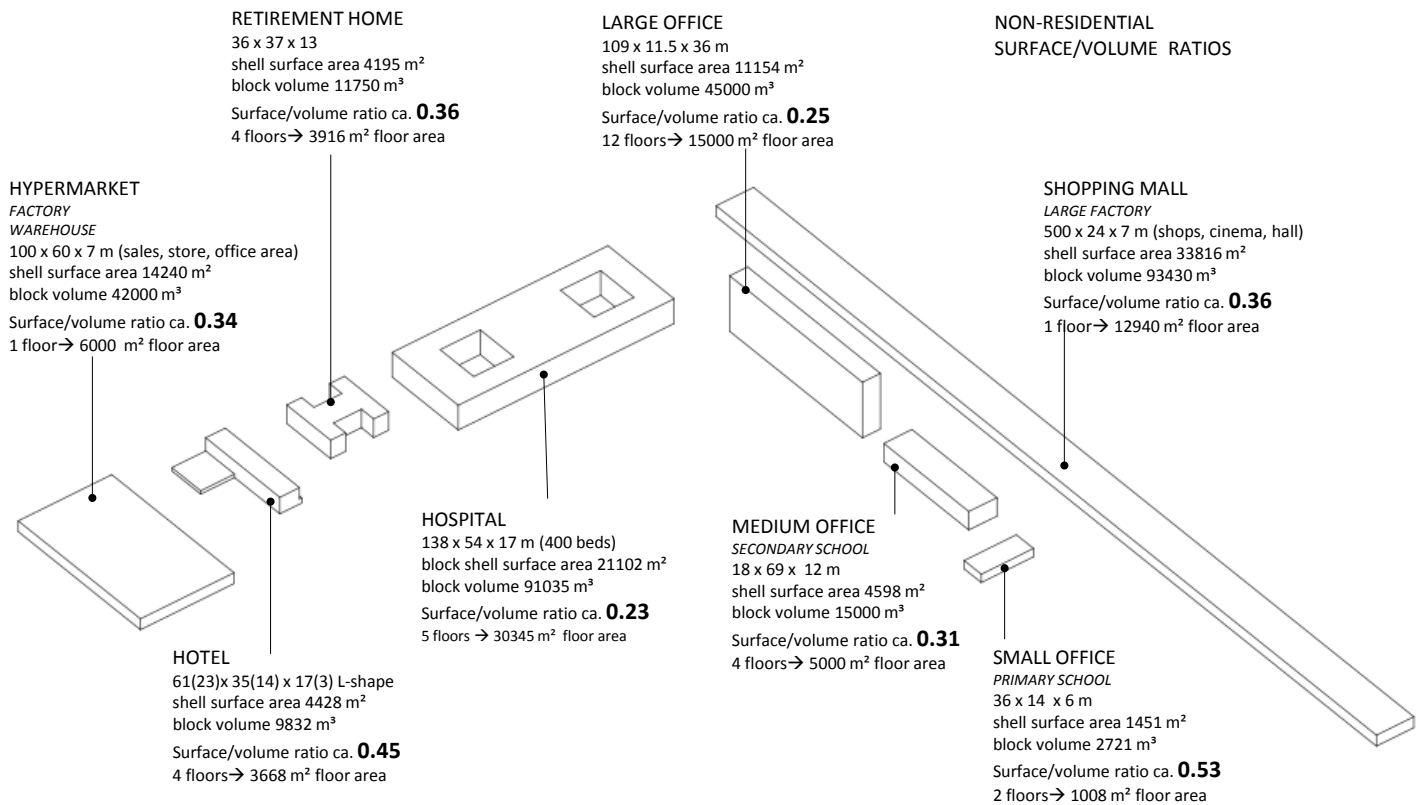

Figure 12. SV ratio of non-residential buildings (picture VHK 2014, based on Armines building data)

As will be elaborated in the following, the average SV ratio for residential buildings is 0.51 and for non-residential buildings it is estimated at 0.32.

#### 4.5 Volumes and surfaces

Based on the definitions, data sources and information in the previous paragraphs the following values for heated building volume  $V$  (in million m<sup>3</sup>@18°C), heated floor surface area  $A$  (in million m<sup>2</sup>@18°C) and heated shell surface area  $S$  (in million m<sup>2</sup>@18°C) were estimated for the EU28 in the year 2010

The NACE units refer to the number of companies registered, not (necessarily) to the number of buildings. They are used as an indicator and were not updated, i.e. they refer to EU25-2005.

**Table 14. EU28-2010 RESIDENTIAL SECTOR BUILDINGS numbers and geometry (Source: VHK 2014)**

RESIDENTIAL SECTOR, Category	block	dwelling	qv	V	A	S/V	S	A/unit
only primary dwellings taken into account	m units	m units	M m <sup>3</sup> /h	M m <sup>3</sup> @18°C	M m <sup>2</sup> @18°C		M m <sup>2</sup> @18°C	m <sup>2</sup> @18°C
Detached dwellings	34	34	9497	12496	4385	0.85	10622	128
Semi-detached (2 dwellings/block)	20	39	10181	13395	4700	0.61	8171	128
Terraced houses (block of 15 dwellings)	2.32	35	8282	10898	3824	0.55	5994	128
<b>Single family/duplex dwellings</b>	<b>56</b>	<b>108</b>	<b>27960</b>	<b>36789</b>	<b>12909</b>	<b>0.67</b>	<b>24787</b>	
City blocks (130 appartments)	12.8	102	11424	24929	8310	0.28	6980	81
Low-rise detached apartment blocks (25 app.)			6419			0.31		
High-rise apartment blocks (130 appartments)						0.24		
<b>Multi-family dwellings</b>	<b>12.79</b>	<b>102</b>	<b>17843</b>	<b>24929</b>	<b>8310</b>	<b>0.28</b>	<b>6980</b>	
<b>TOTAL RESIDENTIAL SECTOR</b>	<b>68</b>	<b>210</b>	<b>45803</b>	<b>61718</b>	<b>21218</b>	<b>0.51</b>	<b>31767</b>	<b>0</b>

**Table 15. PRIMARY & SECONDARY SECTOR BUILDINGS numbers and geometry\* (Source: VHK 2014\*\*)**

NACE	PRIMARY & SECONDARY SECTOR, Category	NACE	V	A	S/V	S	
code		units x1000	M m <sup>3</sup> @18°C	M m <sup>2</sup> @18°C		M m <sup>2</sup> @18°C	
	<b>A - Agriculture, hunting and forestry</b>						
1	<b>Greenhouses (~20 Mm<sup>2</sup> heated), breeding poultry/swine (heated)</b>		<b>202</b>	<b>35</b>	<b>0.35</b>	<b>71</b>	
	<b>D. Manufacturing</b>						
15/16	food & tobacco industry (4.7 m jobs)		333				
17/18	textile & textile products (2.6 m jobs)		218				
19	leather, shoes (0.6 m jobs)		49				
20	wood and wood products (1.3 m jobs)		157				
21/22	pulp, paper, publishing & printing (2.6 m jobs)		232				
23	coke, refineries, nuclear fuel (0.2 m jobs)		2				
24	chemicals & pharmaceuticals, man-made fibres (1.9 m jobs)		35				
25	rubber (tyres) & plastic products (1.7 m jobs)		58				
26	glass, ceramics (incl.cement) (1.6 m jobs)		97				
27/28	base metal & metal products (5 m jobs)		359				
29/30	equipment & machinery (incl. office machines) (3.6 m jobs)		168				
31-33	electric & optical equipment (3.7 m jobs)		165				
34/35	transport equipment (3.2 m jobs)		44				
36/37	manufacturing n.e.c ( 2 m jobs)		241				
	<b>Total Manufacturing (34.5 m jobs)</b>		<b>2158</b>	<b>14544</b>	<b>2424</b>	<b>0.33</b>	<b>4800</b>
	<b>I.64 &amp; D Warehouses</b>						
64	<b>warehouses</b>		<b>4646</b>	<b>774</b>	<b>0.33</b>	<b>1533</b>	
	<b>E - Electricity, gas and water supply</b>						
40/41	<b>Production &amp; transmission electricity, gas, water (1.6 m jobs)</b>		<b>39</b>	<b>291</b>	<b>73</b>	<b>0.33</b>	<b>96</b>
	<b>F-Construction</b>						
45	<b>Construction sector (4 m office, 12.6 m outdoors jobs)</b>		<b>2581</b>	<b>654</b>	<b>182</b>	<b>0.3</b>	<b>196</b>
	<b>TOTAL PRIMARY &amp; SECONDARY SECTOR</b>		<b>4778</b>	<b>20337</b>	<b>3488</b>	<b>0.33</b>	<b>6696</b>



**Table 16 . TERTIARY SECTOR BUILDINGS numbers and geometry (Source: VHK 2014)**

NACE 1.1 code	TERTIARY SECTOR, Category	NACE units	V M m <sup>3</sup>	A M m <sup>2</sup>	S/V	S M m <sup>2</sup>
	<b>G.50 Motor vehicles trade &amp; repair</b>					
50.1	sales	185	576	128	0.34	196
50.2	maintenance & repairs	391	533	118	0.34	181
50.3	wholesale	71	84	19	0.34	29
50.4	sales & repairs motorcycles	41	56	13	0.34	19
50.5	petrol stations	68	31	7	0.34	10
	<b>Total trade and repair motor vehicles (4.1 m)</b>	<b>756</b>	<b>1 280</b>	<b>284</b>	<b>0.34</b>	<b>435</b>
	<b>G.51 Wholesale</b>					
51.1	agents	552	201	56	0.3	60
51.2	seeds, plants, animals, leather	65	48	13	0.3	14
51.3	food & beverages	214	156	43	0.3	47
51.4	consumer durables	422	307	85	0.3	92
51.5	fuels, ore, materials	269	195	54	0.3	59
51.6/8	machinery, tools, telecom	391	284	79	0.3	85
51.7/9	other wholesale	70	51	14	0.3	15
	<b>Total wholesale (9.7 m)</b>	<b>1 983</b>	<b>1 241</b>	<b>345</b>	<b>0.3</b>	<b>372</b>
	<b>G.52 Retail</b>					
52.1	supermarkets and department stores	326	796	221	0.3	239
52.2	specialized: food & tobacco	539	179	50	0.3	54
52.3	chemists, pharmacists, textiles	251	91	25	0.3	27
52.4	clothing, furniture, appliances	1 675	1 658	461	0.3	497
52.2/6	mail order, repairs, other	736	233	65	0.3	70
	shopping malls (general space)	1	240	67	0.3	72
	<b>Total retail (17.1 m)</b>	<b>3 529</b>	<b>3 197</b>	<b>888</b>	<b>0.3</b>	<b>959</b>
	<b>H. Hotels and restaurants</b>					
55.1	hotels, motels, conference centres (11 m hotel beds)	159	1 110	247	0.4	444
55.2	hostels, campings, other tourist lodgings (9 m camp places, 2.2 m other)	117	145	32	0.4	58
55.3	restaurants incl. fast-food	735	1 402	390	0.4	561
55.4	coffee store, bar, discotheque	640	279	78	0.4	112
55.5	canteens and catering	12	28	7	0.4	11
	<b>Total hotels and restaurants (9.2 m)</b>	<b>1 662</b>	<b>2 965</b>	<b>753</b>	<b>0.4</b>	<b>1 186</b>
	<b>Section I - Transportation and storage</b>					
60-62/64	<b>Land/water/air/post &amp; telecom</b> (4.7 m office, 6.3 outside), excl. storage		<b>854</b>	<b>214</b>	<b>0.34</b>	<b>291</b>
	<b>section J- Financial intermediation</b>					
65/66/67	<b>Banks/Insurances &amp; pensions/financial services (6.5 m)</b>		<b>1 064</b>	<b>295</b>	<b>0.28</b>	<b>298</b>
	<b>section K - Real estate, renting and business activities</b>					
70	real estate trade (2.6 m jobs)	1 022	443	123	0.3	133
71	vehicle equipment rentals (0.6 m jobs, ~2 m rental cars/CVs)	154	112	31	0.3	34
72	IT consultancy & software (2.7 m jobs)	496	436	121	0.3	131
73	research & development (0.4 m jobs)	60	44	12	0.3	13
74.1	<i>solicitors, accountants, consultancy</i>	1 366				
74.2	<i>architect and engineering services</i>	741				
74.3	<i>technical testing and analysis</i>	46				
74.4	<i>advertising</i>	165				
74.5	<i>labour and recruitment</i>	31				
74.6	<i>investigation and security</i>	63				
74.7	<i>cleaning, chimney sweeps</i>	164				
74.8	<i>misc. (photographers, packaging, expo &amp; fair, secretariats, call centres, etc.)</i>	784				
74	business services total (18.1 m jobs)	3 359	2 960	822	0.3	888
	<b>Total (24.4 m jobs, 20.9 full time jobs)</b>	<b>5 092</b>	<b>3 996</b>	<b>1 110</b>	<b>0.3</b>	<b>1199</b>
	<b>O.92 Entertainment &amp; news</b>					
92.1	Video & movie production, cinemas	83	908	152	0.3	272
92.2	Radio & TV	23	481	107	0.3	144
92.3	Theatres, dancing, amusement parks	450	1 610	358	0.3	483
92.4	News agencies	37	85	19	0.3	25
	<b>total (3.4 m jobs)</b>	<b>593</b>	<b>3 084</b>	<b>635</b>	<b>0.3</b>	<b>925</b>
	<b>Section O -personal services</b>					
93.0x	<b>Personal services</b> (hairdressers, beauty parlours, laundries, undertakers,	<b>844 762</b>	<b>536</b>	<b>140</b>	<b>0.18</b>	<b>97</b>
	<b>TOTAL COMMERCIAL BUILDINGS</b>	<b>858 377</b>	<b>18 217</b>	<b>4 664</b>	<b>0.32</b>	<b>5 761</b>

**Table 17. PUBLIC SECTOR BUILDINGS numbers and geometry (Source: VHK 2014)**

NACE	PUBLIC & COMMUNITY SECTOR, Category	NACE	V	A	S/V	S
code		units x1000	M m <sup>3</sup> @18°C	M m <sup>2</sup> @18°C		M m <sup>2</sup> @18°C
Code	<b>L - Public administration, defence, social security</b>					
75.11	Home office & municipalities (6 m civil servants)		505	126	0.3	152
75.11	Agriculture (ministry 20%, agencies 80%)		51	13	0.28	14
75.11	Education & culture (Ministry, national labs, etc.)		67	17	0.32	21
75.11	Social affairs ministry		16	4	0.28	5
75.11	Transport (ministry 20%, agencies 80%)		57	14	0.28	16
75.11	Housing & environment (ministry 20%, agencies 20%)		20	5	0.28	6
75.11	Health care & sports ministry		24	6	0.3	7
75.11	International organisations (0.1 m staff)		23	6	0.32	7
75.21	Foreign affairs (incl. embassies)		81	20	0.36	29
75.22	Defence (2.1 m military, 0.3 civil staff)		141	40	0.34	48
75.23/24	Justice, of which		374	97	0.33	124
	-courts (0.2 m staff)		61	15	0.35	21
	-prisons (0.6 m inmates, 0.28 staff)		136	34	0.35	48
	-police/customs/guards (3 m staff)		141	40	0.3	42
	-other (0.26 m staff)		35	8	0.35	12
75.25	Fire service activities (0.15 m prof.)		20	4	0.5	10
75.3	Compulsory social services (0.6 m staff)		55	15	0.3	16
	<b>Total Section L public administration</b>		<b>1807</b>	<b>465</b>	<b>0.32</b>	<b>579</b>
	<b>N - Education</b>					
80.1x	(Pre-)Primary schools (ISCED1 28.5 m pupils)	48 873	1422	395	0.53	753
80.2x	Secondary education (ISCED2 22.9 m, ISCED 3&4 23.6 m pupils)	33 460	1582	439	0.31	490
80.3x	University and higher education (ISCED 5&6 18.8 m students)	13 181	1438	399	0.28	403
80.4x	Other schools and training facilities	268 527	246	69	0.3	74
	<b>TOTAL Education</b>	<b>364 042</b>	<b>4687</b>	<b>1302</b>	<b>0.37</b>	<b>1720</b>
	<b>N - Health and social work</b>					
85.11	Hospitals (2.7 m beds, 74 m <sup>2</sup> /bed, 21°C)	11 777	727	202	0.23	167
85.12	Medical practices & polyclinics (1.7 m doctors)	838 808	491	156	0.28	137
85.13	Dental practices	156 840	69	19	0.29	20
85.14	Medical labs, paramedics, nursing homes	336 928	1556	432	0.3	467
85.20	Veterinary clinics	45 754	20	6	0.3	6
85.3x	Service homes for the aged/disabled/etc. and day-care	73 112	476	132	0.36	171
	<b>Total health and social work (22.4 m jobs)</b>	<b>1 463 219</b>	<b>3340</b>	<b>947</b>	<b>0.29</b>	<b>969</b>
	<b>O 90-92: Other community activities- misc.</b>					
90.0x	waste disposal/sewage [0.7 workers]	363540	149	37	0.34	51
91.x	Political and religious organisations (incl. 200 000 churches)	365000	1147	152	0.3	344
92.5	Libraries, museums, zoos	15910	266	67	0.3	80
	<b>Total misc.</b>	<b>744450</b>	<b>1562</b>	<b>256</b>	<b>0.30</b>	<b>475</b>
	<b>O 90-92: Other community activities- sports</b>					
92.6/7	Commercial sports & betting (ski, golf, riding, boating, etc.)	407010	1662	404	0.34	565
	Public indoor swimming pools (20 000m <sup>3</sup> /unit)	5000	101	8	0.34	34
	Larger sports arena's	520	157	15	0.28	44
	Municipal sports courts (3600 m <sup>3</sup> /court)	150000	545	68	0.4	218
	<b>Total</b>	<b>562530</b>	<b>2465</b>	<b>495</b>	<b>0.35</b>	<b>862</b>
	<b>TOTAL PUBLIC SECTOR &amp; COMMUNITY BUILDINGS</b>	<b>3 134 241</b>	<b>13 861</b>	<b>3 464</b>	<b>0.33</b>	<b>4 604</b>

## 4.6 Volumes and surfaces: average and totals

From the data in the previous paragraph and an estimate of the number of floors the totals and average EU geometry can be derived.

**Table 18. Heated floor area per floor in Mm<sup>2</sup>**

<i>floor nr. --&gt;</i>	1	2	3	4	5	6	Total
Residential single family/duplex	6150	5054	1705				<b>12909</b>
Residential multifamily	831	2327	2160	1828	748	415	<b>8309</b>
Commercial	2015	1375	682	428	164		<b>4663</b>
Public sector	1386	721	678	678			<b>3464</b>
Industrial & storage	2950	477	61				<b>3488</b>
<b>Total</b>	<b>13332</b>	<b>9953</b>	<b>5286</b>	<b>2934</b>	<b>912</b>	<b>415</b>	<b>32833</b>

**Table 19. Heated volume per floor and total -EU28 - 2010, in Mm<sup>3</sup>**

<i>floor nr. --&gt;</i>	1	2	3	4	5	6	Total
Residential single family/duplex	17527	14403	4859				<b>36789</b>
Residential multifamily	2493	6980	6481	5484	2244	1246	<b>24929</b>
Commercial	7855	5380	2785	1605	592		<b>18217</b>
Public sector	6226	2719	2458	2458			<b>13861</b>
Industrial & storage	17429	2691	218				<b>20337</b>
<b>Total</b>	<b>51530</b>	<b>32173</b>	<b>16801</b>	<b>9548</b>	<b>2836</b>	<b>1246</b>	<b>114134</b>

**Table 20. Average floor height - EU28 - 2010, in m**

<i>floor nr. --&gt;</i>	1	2	3	4	5	6	Average
Residential single family/duplex	2.85	2.85	2.85				<b>2.85</b>
Residential multifamily	3.00	3.00	3.00	3.00	3.00	3.00	<b>3.00</b>
Commercial	3.90	3.91	4.08	3.75	3.61		<b>3.91</b>
Public sector	4.49	3.77	3.62	3.62			<b>4.00</b>
Industrial & storage	5.91	5.64	3.60				<b>5.83</b>
<b>Average</b>	<b>3.87</b>	<b>3.23</b>	<b>3.18</b>	<b>3.25</b>	<b>3.11</b>	<b>3.00</b>	<b>3.48</b>

**Table 21. Shell surface area per floor - EU28 - 2010, in M m<sup>2</sup>**

<i>floor nr. --&gt;</i>	1	2	3	4	5	6	Total
Residential single family/duplex	12305	9649	2833	0			<b>24787</b>
Residential multifamily	698	1954	1815	1536	628	349	<b>6980</b>
Commercial	2452	1675	904	553	178		<b>5761</b>
Public sector	2074	896	817	817			<b>4604</b>
Industrial & storage	5749	881	65	0			<b>6696</b>
<b>Total</b>	<b>23278</b>	<b>15057</b>	<b>6434</b>	<b>2905</b>	<b>806</b>	<b>349</b>	<b>48828</b>

Figure 13 gives a simple illustration of the average EU building geometry. As mentioned before, a city block or a row of terraced houses are presumed to be 1 detached building block. The average SV ratio was calculated from the tables above to be 0.43. The average building block was constructed from the given ground floor area and then 'filled up' to the appropriate height, which means that the industrial buildings (including warehouses and greenhouses) ended up being 1.15 floors of 5.9 m per floor. The tertiary buildings are for a small part integrated in the ground floor of apartment buildings but overall they have, at the given ground floor area 2.4 floors of 3.9 m high. The residential buildings end up with 3 floors of 3 m high.

Note that this is an illustration with a simple geometry; it is possible to construct other geometries which are equally valid if e.g. the space is not calibrated to the ground-floor area, but actual average floor dimensions (up to 6 floors). But in all cases the ‘average building’ for space heating purposes would always be a compromise between the average of the heated volume and the shell surface.

Figure 14 presents a compact summary of the findings in Tables 15-18.

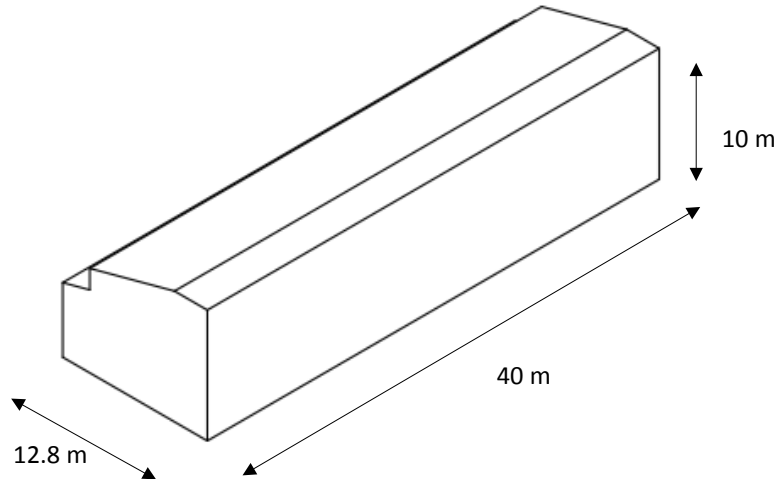

**Figure 13. AVERAGE HEATED BUILDING - EU28 – 2010** [ *Illustrative, calibrated to groundfloor surface area and SV ratio 0.43*, shell surface area 1906 m<sup>2</sup>, block volume 4422 m<sup>3</sup> ] (VHK 2014)

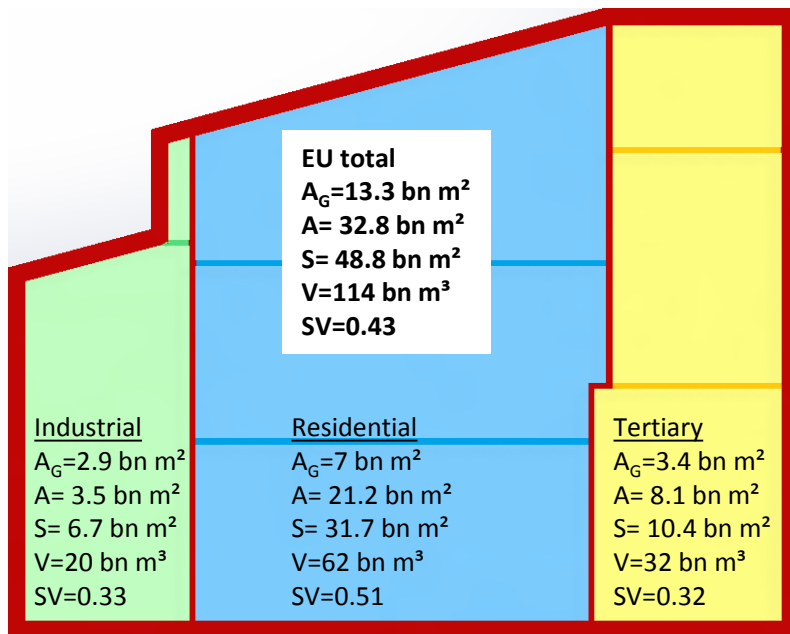

**Figure 14. TOTAL HEATED BUILDING VOLUME S & SURFACES – EU28 – 2010**, Data refer to heated volumes and surfaces (inner dimensions) at equivalent of 18 °C indoor temperature (24/7);  $A_G$ = groundfloor area;  $A$ = total floor area;  $S$ = shell surface;  $V$ = volume ;  $SV$ =  $S/V$  ratio.  $\text{bn} = 10^9$  .

## 5 INSULATION AND VENTILATION

### 5.1 Definition

The assessment of the space heating load requires inputs for

- **U**-value in  $W/(m^2.K)$  for the shell surface  $S$  (in  $m^2$ ) and the indoor-outdoor temperature difference (in  $K$ ).
- Hourly air exchange rate  $q$  in  $m^3/h$  per  $m^3$  of the heated volume  $V$ ;
- Fraction of heat recovered from outgoing air **rec** (dimensionless, often expressed in %);
- The specific heat capacity of air  $c_{air}$  in  $Wh/(m^3.K)$ .

The U-values include a correction for cold bridges. The hourly air exchange rate includes both infiltration through openings in the façade and the intentional ventilation through opening windows and/or through mechanical ventilation. Where there is balanced mechanical ventilation, a part of the heat from the outgoing air may pass its heat through the incoming air by means of a heat exchanger ('heat recovery ventilation'). The specific heat capacity is set as a physical constant set at  $0.343 Wh/(m^3.K)$ .

### 5.2 U-value (insulation)

Insulation values are at the heart of building regulations throughout the EU since the 1970s. There are direct maximum values, relating to roof, walls, windows and floors, and/or they are part of a total energy performance score for new buildings and larger renovations. The maximum U-values (or their inverse the minimum R-values) are being updated on a regular basis and –generally speaking—the building community tends to just comply with them (but no more, except for a few exceptions).

For the statistics this means, once the aged-distribution and building volumes are known (assuming that the average geometry per average unit does not change much) it should be relatively easy to determine the average U-values of the EU building stock. However, there are two major problems:

The first problem is, that these data is usually available at national level, but the retrieval and aggregation to EU-level has just started up and much of the information is anecdotal. The second problem is, that around 40% of the current building stock in most countries was built before 1970 and –especially since the latest crisis—the 'renewal' of the building stock, at currently a pace of 1.1% new buildings and a 0.06% demolition rate per year, is very slow.

Without detailed information on especially the U-values of buildings erected before 1970, it is thus not very useful for the purpose of determining the average space heating load, to spent much effort in retrieving the anecdotal U-value data of the last decades.

Therefore, as in the past, the U-values are built on the Ecofys studies for the insulation sector in 2006. The table below gives an overview:

**Table 22. Insulation and ventilation values (source: Ecofys 2006)**

<b>U-values</b> [W/m <sup>2</sup> K]	< 1975 built	1975-1990 built	1990-2002 built	2003-2006 built	> 2006 built	< 2002 retrofit	2003-2006 retrofit	> 2006 retrofit
<b>HiU</b>								
Roof	0.5	0.2	0.15	0.15	0.13	0.2	0.15	0.13
Facade	0.5	0.3	0.2	0.18	0.17	0.3	0.18	0.17
Floor	0.5	0.2	0.18	0.18	0.17	0.2	0.18	0.17
Windows	3	2	1.6	1.42	1.33	1.6	1.42	1.33
<b>MidU</b>								
Roof	1.5	0.5	0.4	0.25	0.23	0.5	0.25	0.23
Facade	1.5	1	0.5	0.41	0.38	1	0.41	0.38
Floor	1.2	0.8	0.5	0.44	0.41	0.8	0.44	0.41
Windows	3.5	3.5	2	1.84	1.68	2	1.84	1.68
<b>LowU</b>								
Roof	3.4	0.8	0.5	0.5	0.43	1	0.5	0.43
Facade	2.6	1.2	0.6	0.6	0.48	1.4	0.6	0.48
Floor	3.4	0.8	0.55	0.55	0.48	1	0.55	0.48
Windows	4.2	4.2	3.5	3.04	2.71	3.5	3.04	2.71
<b>ventilation values (infiltration + active ventilation)</b>								
[m <sup>3</sup> /m <sup>3</sup> .h]								
<b>HiU</b>	0.9	0.6	0.6	0.4	0.3	0.8	0.7	0.6
<b>MidU</b>	1.2	0.9	0.8	0.7	0.7	1	0.8	0.7
<b>LowU</b>	1.2	0.9	0.9	0.9	0.9	1	0.9	0.9

HiU= FI, SE, DK, NL>1990, MidU & Altitude>600

MidU= AT, DE, FR, IE, UK, BE, LU, NL<1990, LoU & Altitude>600 m

LoU= ES, PO, IT, GR, CY, MT, SI, CZ, SK, HU, RO, BU, PL, LT, LV, EE.

In Lot 1 (2006-2007) the average was estimated to be approximately at the 1990-1995 level.

In the Lot 32 study (draft Feb. 2014) it is estimated that the U-value for windows is 2.32, for walls 0.625, roofs 0.5 and floors 0.625 W/(m<sup>2</sup>.K). Windows make up on average 20% of the average building shell surface (see Lot 32). Taking as an example the average EU building from the previous paragraph the split between windows/walls/roof/floor shell surface areas is approximately 20/30/25/25%. The average U-value is thus 0.93 W/(m<sup>2</sup>.K).

### 5.3 Ventilation rates and recovery

Ventilation rates have been extensively investigated in the preparatory and IA studies for ENER Lot 10 (residential) and ENTR Lot 6 (non-residential). The figures have been subject to scrutiny of all stakeholders (industry, NGOs, experts of Member States, etc.) for a number of years. Nonetheless, all values have been revisited with the latest information and updated. Table 22 gives an overview.

AVERAGE EU BUILDING HEAT LOAD FOR HVAC EQUIPMENT

**Table 23. Ventilation rates EU28 - 2010 (Source: VHK 2014)**

NACE 1.1 code	Description	ventilation				
		qv in M m <sup>3</sup> /h				
		TOTAL	natural	exhaust or supply	balanced	balanced+ HR
	Detached dwellings	9497	7170	2184		142
	Semi-detached (2 dwellings/block)	10181	7686	2342		153
	Terraced houses (block of 15 dwellings)	8282	6253	1905		124
	<b>SINGLE FAMILY/DUPLEX DWELLINGS</b>	<b>27960</b>	<b>21110</b>	<b>6431</b>		<b>419</b>
	Low-rise multi-family dwellings	11 424	7 400	2 900	100	100
	High-rise multi-family dwellings	6 419	2 950	2 850	50	50
	<b>MULTIFAMILY DWELLINGS</b>	<b>16 400</b>	<b>10 350</b>	<b>5 750</b>	<b>150</b>	<b>150</b>
	<b>TOTAL RESIDENTIAL</b>	<b>44360</b>	<b>31460</b>	<b>12181</b>	<b>150</b>	<b>569</b>
A.1	Agriculture (mainly greenhouses)	200	150	33	0	17
D.3	Manufacturing	14400	11 500	2 100	600	200
D.64	Warehouses	4600	3 680	690	161	69
E	Electricity, gas and water supply	288	230	42	12	4
F.45	Construction sector (4 m office, 12.6 m outdoors jobs)	600	240	68	204	87
	<b>TOTAL PRIMARY &amp; SECONDARY SECTOR</b>	<b>20088</b>	<b>15800</b>	<b>2934</b>	<b>977</b>	<b>377</b>
G.50	Trade and repair motor vehicles	1 267	507	145	431	185
G.51	Wholesale	1 229	492	140	418	179
G.52	Retail	3 517	1 055	468	1 396	599
H.55	Hotels and restaurants	3 354	671	510	1 522	652
I.60-64	Transportation and storage	1015	406	112	345	152
J.65-67	Financial intermediation	947	284	126	374	163
K.70-74	Real estate, renting and business activities	3 562	1 425	406	1 212	519
O.92	Entertainment & news	3053	611	464	1 385	593
O.93.0x	Personal services	700	210	93	278	119
	<b>TOTAL COMMERCIAL BUILDINGS</b>	<b>18 646</b>	<b>5 660</b>	<b>2 464</b>	<b>7 361</b>	<b>3 161</b>
L.75	Public administration, defence, social security	1656	1 242	79	235	100
N.80	Education	3 960	2 376	2 079	99	198
M.85	Health and social work	5 400	1 620	718	2 143	919
O 90-92	Political, religious, cultural	1547	1 470	78	0	0
O. 92.6/7	Sport	2541	762	338	1 008	432
	<b>TOTAL PUBLIC SECTOR &amp; COMMUNITY BUILDINGS</b>	<b>15 104</b>	<b>7 471</b>	<b>3 292</b>	<b>3 485</b>	<b>1 649</b>
	<b>TOTAL NON-RESIDENTIAL</b>	<b>53838</b>	<b>28931</b>	<b>8689</b>	<b>11823</b>	<b>5188</b>
	<b>TOTAL ALL BUILDINGS (Mm<sup>3</sup>/h)</b>	<b>98198</b>	<b>60391</b>	<b>20870</b>	<b>11973</b>	<b>5757</b>
	<i>TOTAL ALL BUILDINGS (%)</i>	<i>100%</i>	<i>61%</i>	<i>21%</i>	<i>12%</i>	<i>7%</i>

The table indicates an EU ventilation rate  $q$  of 98 billion  $\text{m}^3$ . Taking into account the EU heated volume of 114 billion  $\text{m}^3$  determined in the previous chapter this gives an overall air exchange rate  $q$  of  $0.86 \text{ m}^3 \cdot \text{h} / \text{m}^3$ . For the residential sector  $q$  is 0.72, for the tertiary sector  $q$  --including high ventilation buildings such as hospitals, laboratories and swimming pools--  $q$  is 1.2 and for the industrial buildings  $0.74 \text{ m}^3 \cdot \text{h} / \text{m}^3$  air exchange is estimated. e.g. hospitals, is 5%, for the industrial sector 0%.

For almost 7% of the total flow there is heat recovery. Estimating the thermal efficiency at 60%, this means that  $\text{rec}$  is 4% (0.04) and thus  $=0.82$ . For the residential and tertiary sector the  $\text{rec}$  is 5%, for the industrial sector 0%.

From the above it can be calculated that the overall effective ventilation rate that is relevant for space heating is  $q \cdot (1 - \text{rec}) = 0.82 \text{ m}^3 \cdot \text{h} / \text{m}^3$ , with 0.68 for residential buildings, 1.15 for tertiary sector buildings and  $0.71 \text{ m}^3 \cdot \text{h} / \text{m}^3$  for industrial buildings.



## 6 HEAT LOAD

### 6.1 Calculation

For the EU28 it is now possible to calculate the total heat load with the equation from Chapter 2:

$$Q_{\text{building}} = 0.001 \cdot \Delta T \cdot t_{\text{heating}} \cdot [ S \cdot U + V \cdot q \cdot (1-\text{rec}) \cdot c_{\text{air}} ]$$

becomes

$$Q_{\text{building}} = 0.001 \cdot 7.5 \cdot 4910 \cdot [ 48.8 \cdot 0.93 + 114.1 \cdot 0.86 \cdot (1-0.04) \cdot 0.343 ] \approx 2860 \text{ TWh} \approx 10.3 \text{ EJ}^{69}$$

subdivided in residential 1725 TWh (60.3%), tertiary 687 TWh (24%) and industrial 448 TWh (15.7% of total) buildings annual heat loads, using the data from the previous paragraphs.

For the 210 million residential primary dwellings the average heat load is thus 8214 kWh/a. Per degree indoor-outdoor temperature difference (7.5 °C) this is 1095 kWh/a. This confirms that the internal heat gain of 2500 kWh/a is equivalent to 2.3 °C.<sup>70</sup>

Using the two terms of the equation, the total can also be subdivided in 59% transmission losses (including cold bridges) and 41% ventilation and infiltration losses. Divided over the 11.5 K gross temperature difference, this amounts to 6.5 (transmission losses) and 4.5 K (ventilation losses).

The following diagram gives a summary.

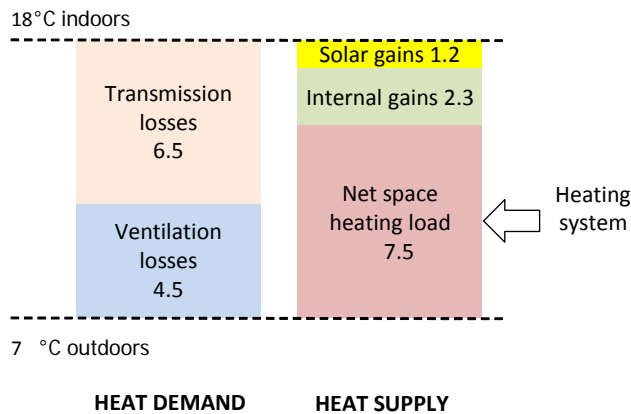

Figure 15. Average EU Heat balance for space heating 2010 (VHK 2014)

<sup>69</sup> Actual values are 3052 TWh and 10987 PJ (Eta Joule: 1EJ = 1000 PJ).

<sup>70</sup> Mathematically this is more of an iteration than a straightforward calculus, because the value is used both as an input and an output; still, it works.

## 6.2 Ecodesign coverage of space heating load

The aim of the study is to make a best possible estimate for the heating load of HVAC equipment that is regulated by Ecodesign and possibly for the energy labelling measures. The logical next step, after having established the total heat load of the EU building stock at 2816 TWh/a in 2010, is to establish which part of the total EU space heating load is covered by Ecodesign-regulated equipment.

The Ecodesign regulation does not include

- District heating;
- CH boilers with nominal power larger than 400 kW;
- Cogeneration space heaters ('CHP') with electrical capacity larger than 50 kW;
- Steam boilers;
- Waste heat recovery from industrial equipment/processes.

As is shown in the next paragraphs, the district heating represents an energy use of 448 TWh in 2010-2011. This is heat measured at the place of use, i.e. the figure does not include generation losses. Taking into account some 10% losses from e.g. suboptimal controls, the heat load of buildings with district heating can thus be estimated at around 400 TWh.

Industrial steam boilers, CHP for internal use and waste heat recovery are estimated to be the largest contributors to space heating in industry, but it is very difficult to separate the (high/medium) temperature process heat from the low-temperature space heating end-use. Based on anecdotal data, it is estimated that dedicated space heating equipment covers only one-third of the total heat load and two-thirds, i.e. around 300 TWh/a, comes from equipment that is (currently) not in the scope of Ecodesign measures<sup>71</sup>.

Regarding the share of large heating boilers (>400 kW) there are no statistical data. These would typically be used to heat large buildings in the industrial and service sector (e.g. hospitals, large hotels, schools, offices) or as block heating boilers in large apartment buildings. It is estimated that these large boilers serve some 5% of the total space heating load, i.e. ~140 TWh.

Based on the above, with large uncertainties, it is plausible that 840 TWh of the 2861 TWh heat load is covered by equipment that is currently not in the Ecodesign-scope. This would mean that 2020 TWh would be the space heating load that is covered by products in the scope of Ecodesign.

However, the EIA report indicates a space heating load of 1801 TWh in 2010. This is 11% more.

The question is what would be the consequence of adjusting the heat loads? Does it mean that the energy consumption for space heating equipment in the EIA report was underestimated or was the efficiency of the heating systems underestimated?

---

<sup>71</sup> Lauterbach, Christoph, *Potential, System Analysis and Preliminary Design of Low-Temperature Solar Process Heat Systems*, kassel university press GmbH, 2014. Lauterbach mentions 11% of industrial heat (in 2010) is going to space heating applications, explicitly defined as such. For the EU 2012 the final consumption is 283 Mtoe, of which 87 Mtoe electricity. Taking into account only fossil fuel as source for heating (196 Mtoe, 2280 TWh) this would mean 250 TWh that goes to dedicated space heating equipment. Assuming a heating system efficiency of e.g. 60% this would mean that only 150 TWh of space heating load is covered. This is one-third of the industrial space heating load of 449 TWh. Also consulted are various IPPC-BREFs (see regarding waste heat use and CHP. IPPC=Integrated pollution prevention and control. See: [eippcb.jrc.ec.europa.eu](http://eippcb.jrc.ec.europa.eu))

The EU space heating primary energy consumption in the EIA report was 3357 TWh in 2010. This suggests an overall efficiency of 54%.<sup>72</sup> For the efficiency values there is, apart from the EIA report and the underlying preparatory studies and impact assessments, no other independent source that would allow to verify which option is (more) correct.

For the energy consumption of space heating the Eurostat Energy Balance could be a basis for comparison.

### 6.3 Eurostat Energy Balance

The annual Eurostat Energy Balance is the reference for most EU energy policy studies like PRIMES. It would be the ultimate check whether the estimates in the previous chapters make sense and establish the order of magnitude of the possible error of the aggregate.

Eurostat's Energy Balance does not supply the figures for space heating energy directly. However, it does specify the use of fossil fuels (natural gas, heating oil, LPG, solid fuels, derived heat, etc.) that are predominantly used for space heating in the residential and services sector. If we use the EIA report estimates to exclude non-space heating uses for these fuels, like water heating and cooking, we have a fair estimate of the fossil fuel use for heating. For electricity the share of electricity-driven space heaters (resistance heaters and heat pumps) can only be established by applying (corrected) EIA report numbers, but still the fossil fuels dominate space heating and the comparison would still be valuable.

For the industrial sector it is more difficult to derive the estimate from Eurostat's Energy Balance. There is a large variety of space heating sources like steam boilers (the low temperature cascade), low temperature process waste heat, combined heat & power (CHP), etc. But especially in the manufacturing industry there is a fair share of dedicated, conventional central heating boilers. Also large air heaters in industrial warehouses are typically included in the current Ecodesign scope.

The same goes for the agricultural sector, which uses central heating boilers and certain local heaters that fall in the scope of Ecodesign e.g. for poultry farming and greenhouses.

---

<sup>72</sup> 1801/3357 TWh=54% .

**Table 24. Final consumption of selected energy sources possibly used for heating \*\*\*(source: Eurostat EU28 Energy Balances 1990-2012, 2014 edition)**

in TWh*	Solid fuels	LPG	Kerosine ('Other')	Gas Oil (w/o bio)	Fuel Oil	Gas (total)	Solid Biomass	Derived heat	Electricity
<b>Residential</b>									
2012	108	73	36	330	2	1 259	454	252	828
2011	107	76	36	329	3	1 175	421	256	803
2010	126	85	47	371	4	1 406	449	265	845
2005	103	99	41	488	8	1 370	355	261	806
2000	118	101	40	508	14	1 312	331	271	720
1995	220	102	32	565	14	1 101	296	303	659
1990	378	98	27	546	27	912	258	320	609
<b>Services</b>									
2012	13	22	1	162	4	531	13	106	845
2011	17	23	0	167	6	512	12	110	829
2010	19	25	0	188	7	583	12	117	850
2005	12	30	1	228	11	523	9	104	732
2000	17	22	1	227	12	354	7	73	633
1995	46	18	2	241	29	421	7	56	515
1990	143	17	2	252	37	314	4	53	441
<b>Industry**</b>									
2012	37	21	17	80	24	177	35	74	1 008
2011	39	24	17	78	28	184	42	65	1 037
2010	40	24	19	90	36	196	41	76	1 030
2005	54	28	19	128	66	209	35	88	1 133
2000	85	33	16	128	95	212	31	59	1 061
1995	110	30	8	123	135	191	57	85	961
1990	177	25	7	126	197	288	59	158	993
<b>Agriculture</b>									
2012	14	8	0	138	2	46	17	3	44
2011	14	8	0	143	2	43	17	3	45
2010	16	8	0	147	2	43	19	3	44
2005	12	9	0	177	8	45	15	4	44
2000	13	8	1	182	8	47	14	6	40
1995	23	7	1	196	16	48	14	7	40
1990	21	7	1	192	11	55	9	17	49
<b>TOTAL of the above</b>									
2012	172	124	53	710	32	2 013	519	435	2 725
2011	177	131	53	717	40	1 914	492	435	2 714
2010	201	143	66	795	50	2 227	521	461	2 769
2005	181	165	61	1 021	93	2 146	414	458	2 714
2000	233	164	58	1 046	129	1 925	383	409	2 454
1995	398	157	44	1 124	193	1 761	375	452	2 175
1990	720	147	37	1 116	272	1 569	330	547	2 093

\* 1 TWh=11.63 Mtoe. All fuels are expressed in Net Calorific Value (NCV) primary energy, electricity in TWh electric. Consumption figures are given for non-transport applications (Transport is a separate category)

\*\* Solid fuels, LPG, Kerosine, Gas Oil, Fuel Oil, Waste(non-renewable): Transport Equipment, Machinery, Food, Paper, Wood, Construction, Textile, Non-specified Industry are included. Gas includes Transport Equipment, Machinery, Wood, Construction, Textile, Non-specified Industry (Food, Paper and Textile as well as heavy industry are excluded). For Biomass all industry is included except the Paper and Wood industry. For Solar thermal and Geothermal all industry is included. For derived heat all industry is included \*\*except the Chemical and Paper industry. The electricity includes all industry (only small part is space heating, but this gives the total)

In other words, the assessment of the total space heating energy consumption from Eurostat's Energy Balance will not be perfect, but it is at the moment the only alternative to the 'bottom-up' data of the EIA report.

The annual Energy Balance sheets are now available for the EU28 and the years 1990-2012 (status 2014). Table 24 on the next page gives the energy balance figures, in TWh, for selected fuels (and electricity) that are relevant for heating and cooling purposes. The note below the table gives the way the industry totals were assessed.

## 6.4 Converting the Energy Balance to a space heating balance

In order to use the energy balance for an estimated space heating consumption a few adjustments have to be made:

- The reference in the previous chapters is the year 2010. This year had a cold winter, whereas 2011 had a relatively warm winter. In order to compensate for changes in weather conditions the straight average of 2010 and 2011 data is used.
- The electricity data from the Eurostat energy balance cannot be used. For this column the data for electric local space heaters, electric heat pumps and auxiliary electricity have to be used directly from the EIA report (verified by 3<sup>rd</sup> party data); they are then partitioned between the sectors in proportion to the split-up without electricity and derived heat.
- In the EIA data 'derived heat' is missing (out of scope); these values have to be copied from Eurostat and will be partitioned according to the EIA split-up without electricity and derived heat.
- Eurostat specifies kerosene, gas oil and (heavy) fuel oil consumption for non-transport applications. In principle they can all be used for space heating, but the fuel oil in the industry is primarily used as process heating, typically in steam boilers. Therefore the industrial fuel oil is excluded from the accounting.
- In the agricultural sector 80% of gas oil is used for off-road vehicles and machinery and 30 TWh of agricultural gas is used in (CHP) gas motors.
- The energy consumption has to be split into space heating and the other applications (water heating, cooking); this is done on the basis of the EIA data.
- The EIA data are given, as in the study, per type of heating system; Eurostat data is given per sector.

The result of the adjustments is given in Table 25 hereafter.

**Table 25. Final consumption heating applications EU28, 2010, Eurostat versus Ecodesign Impact Accounting**

in TWh, primary (p) or electric (e)	Solid fuels	Oil	LPG	Gas	Bio-mass	SUBTOTAL excl. elec & der.heat	Derived heat	Electricity	TOTAL	TOTAL (Elec * 2.5)
	TWh p	TWh p	TWh p	TWh p	TWh p	TWh p	TWh p	TWh e	Twhp+ Twhe	TWh p
<b>Based on Eurostat Energy Balance</b>										
Residential	116	395	81	1 291	435	2 318	260	422	3 001	3634
Services	18	184	24	547	12	786	114	166	1 065	1314
Industry*	40	102	24	190	42	397	71	72	540	648
Agriculture	14	29	8	15	17	82	3	15	100	123
<b>TOTAL</b>	<b>188</b>	<b>710</b>	<b>137</b>	<b>2 042</b>	<b>506</b>	<b>3 582</b>	<b>448</b>	<b>653</b>	<b>4 683</b>	<b>5663</b>
		2 889								
<b>Based on Ecodesign Impact Accounting</b>										
<b>space heating</b>	<b>44</b>	<b>2221</b>			<b>270</b>	<b>2535</b>	<b>403</b>	<b>347</b>	<b>3 285</b>	<b>3805</b>
-CH boiler		1992				1992		123		
-Solid fuel boiler	30				135	165		0		
-Central air heating		198				198		35		
-Local space heater	14	0	31	135		180		167		
-Room airco reversible						0		22		
<b>water heating</b>		<b>581</b>				<b>581</b>	<b>45</b>	<b>252</b>	<b>878</b>	<b>1256</b>
-dedicated WH		175				175		249		
-CH Combi		406				406		2		
<b>cooking (res only)</b>		<b>72</b>				<b>72</b>		<b>54</b>	<b>126</b>	<b>207</b>
-residential hob		29				29		31		
-residential oven		10				10		23		
-non-res. cooking/laundry		33				33		na		
<b>TOTAL in TWh</b>	<b>44</b>	<b>2874</b>			<b>270</b>	<b>3188</b>	<b>448</b>	<b>653</b>	<b>4 289</b>	<b>5269</b>
<b>Difference in TWh</b>	144	15			236	394	-	-	394	394

Numbers in red font are VHK estimates (see text)

\*=Large part of the non-Ecodesign equipment in the industry sector is not included because only data from selected sector was included. Nonetheless, a significant part of this heat load could be covered by steam boilers, process waste heat, etc..

## 6.5 Conclusion on heat load

This chapter gives the best estimate for the heat load, but it must be mentioned that uncertainties in the data input are still considerable.

Table 24 shows that for the largest group of energy sources -- Gas, Oil and LPG-- the data are consistent between Eurostat and EIA. This implies, given that the space heating load is 10% higher than currently indicated in the EIA report, the efficiency of the stock in the EIA report should be 10% better.

As regards the other energy sources (solid fuels, biomass, derived heat and electricity) it is not possible to draw a specific conclusion from the comparison between Eurostat and EIA because too many data are missing. A new study, out of the scope of this limited study, would be required to make a better estimate of the market (and energy use) of especially the non-residential sector solid fuel and biomass equipment.

Based on the above it is proposed to only make changes to the product group of central heating boilers, which is by far the largest group. Efficiency of the stock (EFNECO sheet) should be 60% instead of 54% and the load per boiler (sheet LOAD) and for the EU as a whole (sheet EULOAD) should be increased by 10%.

This is also consistent with observations from market researchers of BRG Consult, who saw a more rapid than anticipated increase in the efficient (condensing) boilers share over the 2005-2010 period.<sup>73</sup> For the most recent years (2011-2013) BRG Consult saw a slowdown in the growth of condensing boilers, whereas in the EIA report --based on the Lot 1 study-- it was expected that this growth would be faster.

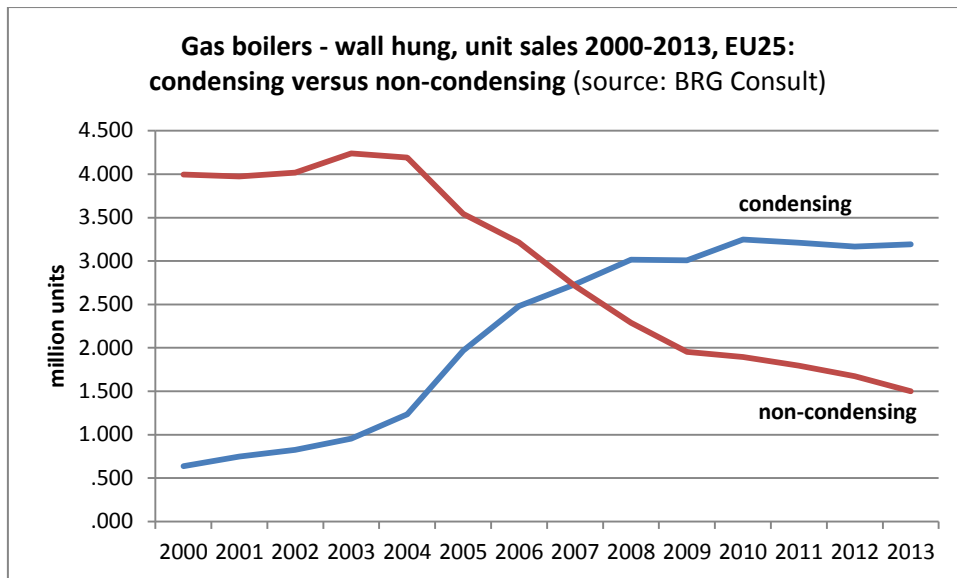

**Figure 16. Wall-hung gas boilers, unit sales 2000-2013, EU25 (EU28 minus Luxembourg, Malta and Cyprus) of condensing and non-condensing types. Data for 2012 and 2013 are projections (source: BRG Consult, 2012)**

<sup>73</sup> BRG Consult pers. comm.. BRG Consult is the leading market research company for the EU boiler market and was part of the Lot 1 (Boilers) study team for Task 2 (market data).

## 7 TREND

### 7.1 Introduction

This chapter on trends takes as reference the Ecodesign Impact Accounting (EIA) study, Part 1. The EIA study is a harmonised compilation of all preparatory and impact assessment studies available on November 2013. Hereafter the trends are discussed first in general terms and then per product group, i.e. central heating boilers, local space heaters, solid fuel boilers, reversible room air conditioners and central air heating equipment.

### 7.2 General

In the EIA study the following trends for the period after 2010-2020 were taken into account:

- The heat load per heating system will increase by 0.5% per year because of the growth of the average floor area per dwelling and workplace<sup>74</sup>.
- The heat load per heating system will decrease by 1.2-1.5% per year because of better insulation and less ventilation heat losses.<sup>75</sup> A best estimate is that improvement of insulation and ventilation efficiency can yield an improvement of 1.2% per year.
- The total heat load will increase by 0.2% per year, because some residential consumers –mainly in Southern and Eastern parts of the EU-- will switch from ‘no heating’ or a single local heater in kitchen/living room to whole house heating (central heating, reversible room air conditioners in every room, etc.).<sup>76</sup>
- The total heat load will increase by 0.3% per year because of the growth in the number of households (0.25% per year) and the replacement of demolished buildings (0.03% per year)

Combining the points above, the overall effect is a decrease in the space heat load per heating system by 0.7-1% per year (7-10% over 2010-2020). The decrease in the total EU space heating load is 0.2-0.5% per year. Over the 2010-2020 period a decrease around a middle value of 3.5% can be expected.

Not taken into account in the (preparatory studies underlying the) EIA report are:

- The decrease of the internal gains due to energy efficiency improvement. If, as projected, there is a 16% decrease in energy for lighting and appliances by 2020 (with respect of 2010), the internal heat gain which currently is believed to contribute 2.3 °C, will then only contribute 1.9 °C. This is a 0.4 °C deficit that has to be filled in by space heaters (c.p.).

<sup>74</sup> E.g. from 87 m<sup>2</sup> in 2003 to 94-95 m<sup>2</sup>/dwelling in 2020,

<sup>75</sup> Taking into account the growing floor area per dwelling the, SAVE study –building on a 1960-2005 historical data— predicted a decrease of 900 kWh (12%). The IDEAL-EPBD project estimates a saving potential of 10% on the EU building stock in 2020 (20% in 2030) due to EPBD measures. New housing and new tertiary sector buildings, to be built at Nearly Zero-Energy level, will add another 2.5-3% to the saving potential, making a total of 13%. The actual saving will depend on the effectiveness of the building-related measures.

<sup>76</sup> Estimate based on 0.5% of the population making the switch, increasing the average indoor temperature by 2-3 °C (because the bedrooms are also heated), which is up to 40% of the indoor-outdoor temperature difference  $\Delta T$  that is causing the heat demand (  $0.5\% * 0.4=0.2\%$  ).



- The increase in outdoor temperature due to continued urbanisation ('urban heat island' effect) at a rate of 0.2 °C per decade.
- The increase in outdoor temperature due to globalisation ('urban heat island' effect) at a rate of 0.2-0.3 °C per decade.

These three effects compensate each other and do not affect the trends mentioned earlier.

### 7.3 Central heating boilers

According to the EIA report, in 2010 there were 111 million CH boilers installed in the EU, with a heat load (output) per boiler of 10 595 kWh/a. The total EU load was thus 1176 TWh. The average heating system efficiency of the installed boiler system<sup>77</sup> was 52% and thus the energy consumption is 2261 TWh (ECO scenario).

The space heating load for boilers shows a decrease of 3.7% between 2010 and 2020, i.e. from 1176 TWh in 2010 to 1133 TWh in 2020 (see figure 16 below). This is in line with the estimates in paragraph 7.2.

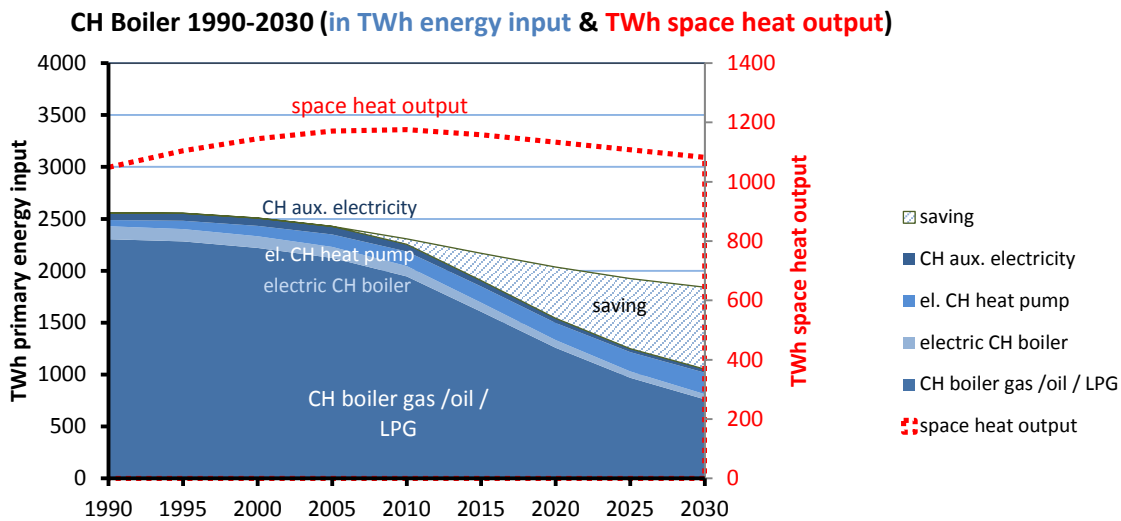

Figure 16. Central heating boilers, energy input and heating output 1990-2030 (source: VHK, EIA report 1, 2014)

<sup>77</sup> Note that this is not the strict boiler efficiency at best operating conditions, as used e.g. in advertisements. The heating system efficiency includes the actual boiler efficiency at real conditions (including the consequences of oversizing, on-off operation at very low loads, etc.), the electricity consumption of boiler controls and CH pump, heat losses of the distribution system (piping, buffers) as well as temperature fluctuation and stratification losses (=higher average indoor temperature) caused by deficiencies in boiler and room temperature controls.

## 7.4 Local space heaters

In 2010 there were 265 million local space heaters installed in the EU, with a heat load (output) per unit of 890 kWh/a. The total EU load was 236 TWh. The average heating system efficiency is 39% and the energy consumption is consequently 597 TWh (ECO scenario).

In the EIA report the load of local heaters shows a slight increase of 7% between 2010 and 2020, i.e. from 236 TWh in 2010 to 252 TWh in 2020 (see figure 17 below). The increase is mainly due to closed fireplace inserts (27→37 TWh) and pellet stoves (6→12 TWh), which show the highest increase in sales.

It is remarkable that, except for coal stoves and flueless heaters, for none of the local heater types a significant reduction in sales is foreseen in the EIA report. For instance for most types of electric heaters, the EIA report predicts a CAGR<sup>78</sup> volume growth of 6-7% over the 2010-2020 period. This is in contrast with market surveys from Euromonitor, which report a sharp decline of electric heater sales in the French market, following new building regulations<sup>79</sup>. For the future Euromonitor expects a negative volume CAGR of 1% for electric (resistance) space heaters over the 2013-2018 period.

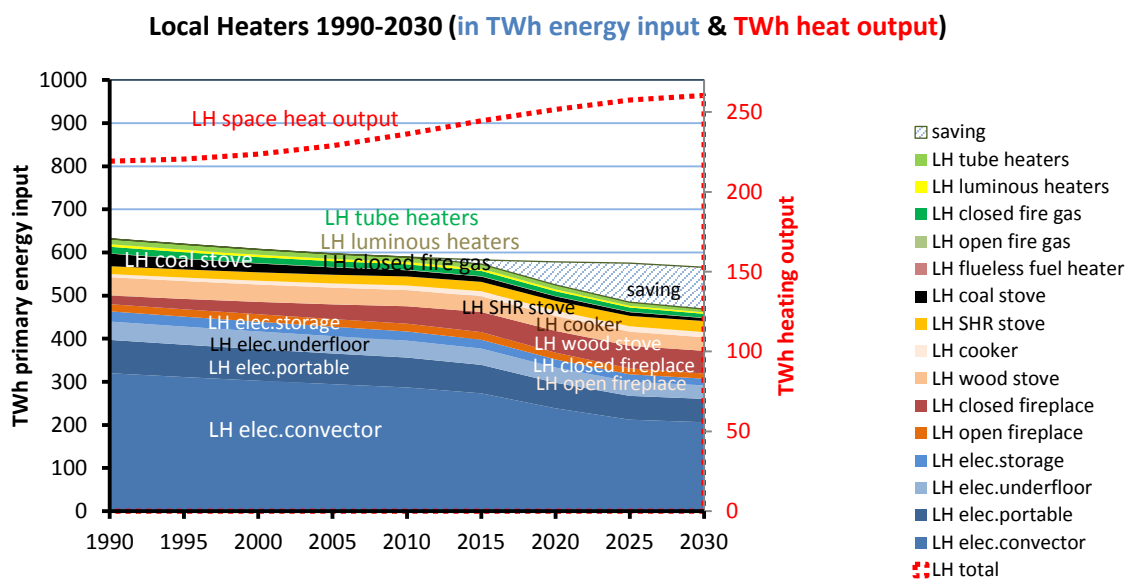

Figure 17. Local space heaters, energy input and heating output 1990-2030 (source: VHK, EIA report 1, 2014)

<sup>78</sup> CAGR: Compound Aggregate Growth Rate

<sup>79</sup> <http://www.euromonitor.com/heating-appliances-in-france/report> (2013)

## 7.5 Solid fuel boilers

In 2010 approximately 5.3 million solid fuel boilers of all types were installed in the EU, with a heat load per unit of 22000 kWh/a. The total EU load was 117 TWh. The average heating system efficiency is 71% and the energy consumption is 165 TWh.

The trend in the EIA report shows a sales decrease for coal-fired and manual wood boilers, whereas the direct draft wood boilers, pellet boilers and woodchip boilers are growing. The overall result is a slight increase at a CAGR of 7% over the 2010-2020 period.

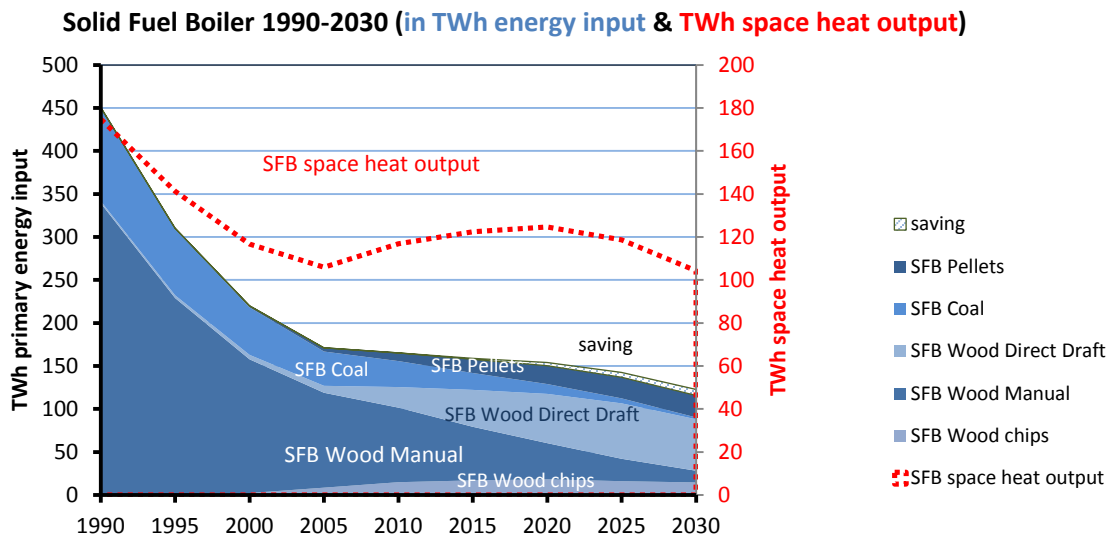

Figure 18. Solid fuel boilers, energy input and heating output 1990-2030 (source: VHK, EIA report 1, 2014)

## 7.6 Central air heating equipment

In 2010 approximately 3.8 million central air heaters of all types were installed in the EU, with a heat load per unit of 57677 kWh/a. The total EU load was 219 TWh. The average heating system efficiency is 75% and the energy consumption is 286 TWh.

In the EIA report the load of local heaters shows an increase at a CAGR of 11% between 2010 and 2020, i.e. from 219 TWh in 2010 to 245 TWh in 2020 (see figure 23 below). The increase is mainly due to the increased sales of electric reversible air conditioners at a CAGR of 39%, while gas- or oil fired central air heating is expecting decline at a CAGR of 13% over the 2010-2020 period.

Especially the large sales increase of electric reversible air conditioners is questionable. Several market surveys report a stable or even negative volume growth over the last 3-5 years for the EU, with little optimism about a rise in the near future.<sup>80</sup>

<sup>80</sup> For instance: <http://www.rehva.eu/publications-and-resources/hvac-journal/2012/052012/hvacr-market-in-europe-the-middle-east-and-africa-emea/> or [http://www.hydrocarbons21.com/articles/european\\_market\\_for\\_air\\_conditioners\\_contracts](http://www.hydrocarbons21.com/articles/european_market_for_air_conditioners_contracts) (2013)

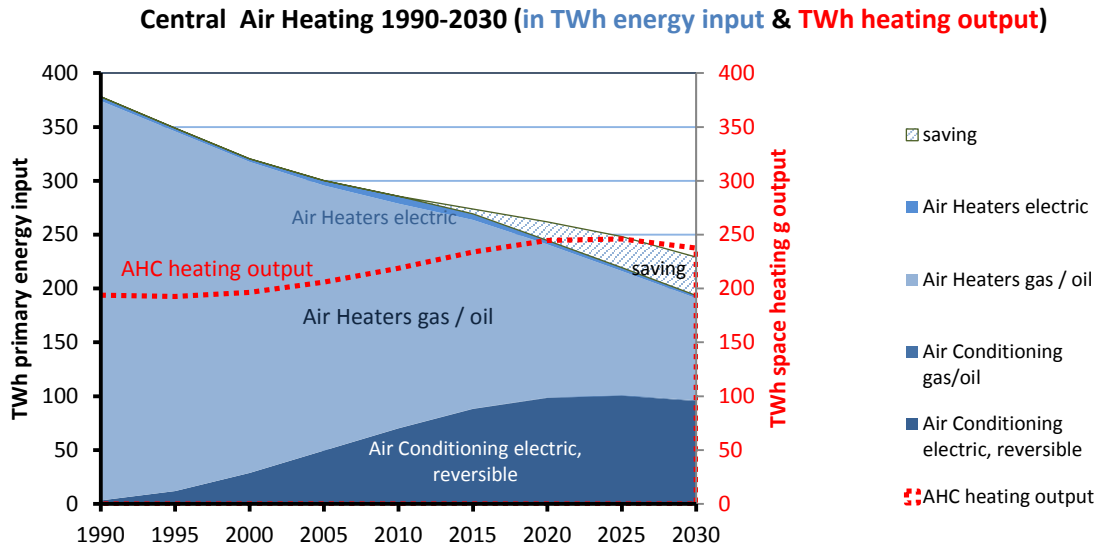

Figure 19. Central air heating equipment, energy input and heating output 1990-2030 (source: VHK, EIA report 1, 2014)

### 7.7 Reversible room air conditioners ( heating )

In 2010 approximately 28.5 million reversible room air conditioners (<12 kW) were installed in the EU, with a heat load per unit of 2065 kWh/a. The total EU load was 59 TWh. The average heating system efficiency is 75% and the energy consumption is 55 TWh primary energy (22 TWh electric).

In the EIA report the load of local heaters shows a doubling between 2010 and 2020, i.e. from 59 TWh in 2010 to 127 TWh in 2020 (see figure 20 below).

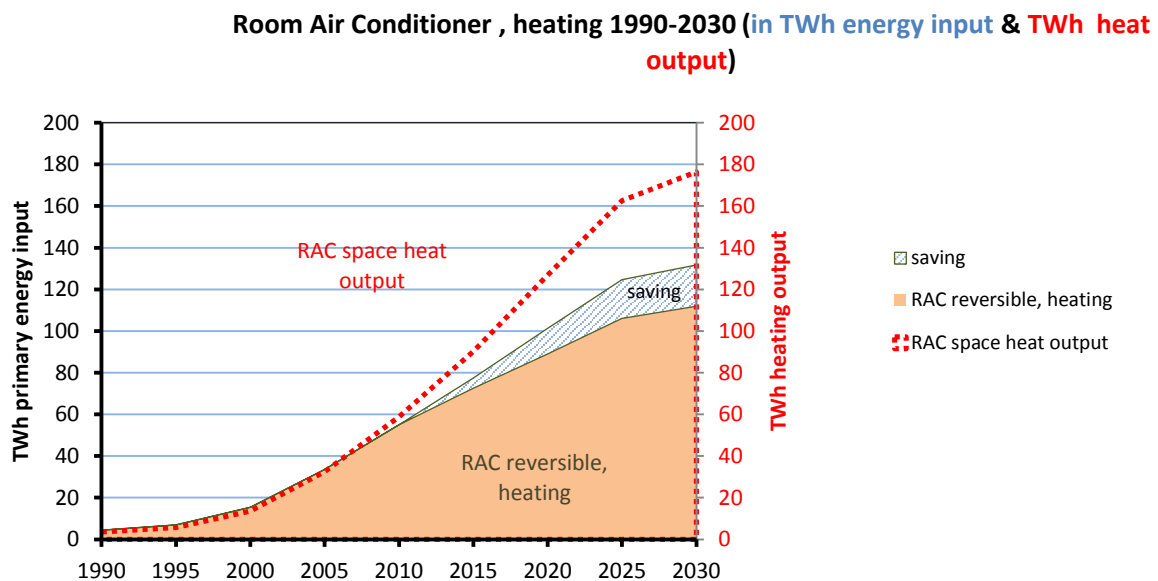

Figure 20. Room air conditioner energy input and heating output 1990-2030 (source: VHK, EIA report 1, 2014)

The EU sales growth rates in EIA, taken from the 2009 preparatory study, are probably overestimated. The EIA report predicts a doubling of EU sales of reversible RACs over the period 2010-2020, whereas Daikin Europe, EU market leader in room air conditioners, reported hardly any growth over the last three years<sup>81</sup>. Reportedly, sales increased in Central Europe and Turkey, while demand in Western Europe dropped. This implies that the estimated heating load ('output') of 127 TWh in 2020 (from 59 TWh in 2010) should be corrected downward to a level of 80-90 TWh in 2020.<sup>82</sup>

### 7.8 Conclusion on trends

The aggregated EU space heat load increase in the EIA report is 4% over the 2010-2020 period (+0.4% year-on-year), whereas based on the trends a 3-4% decrease was expected (-0.3 to -0.4% year-on-year). In as much as can be assessed in this limited study, the main cause is exaggerated sales expectations of electric local space heaters and air conditioners in the EIA report. It is recommended to adjust the sales figures for these products as appropriate.

After 2020, when also more stringent requirements for nearZero Energy buildings and renovations are implemented, the space heating load (output) in the EIA report decreases, more or less as expected.

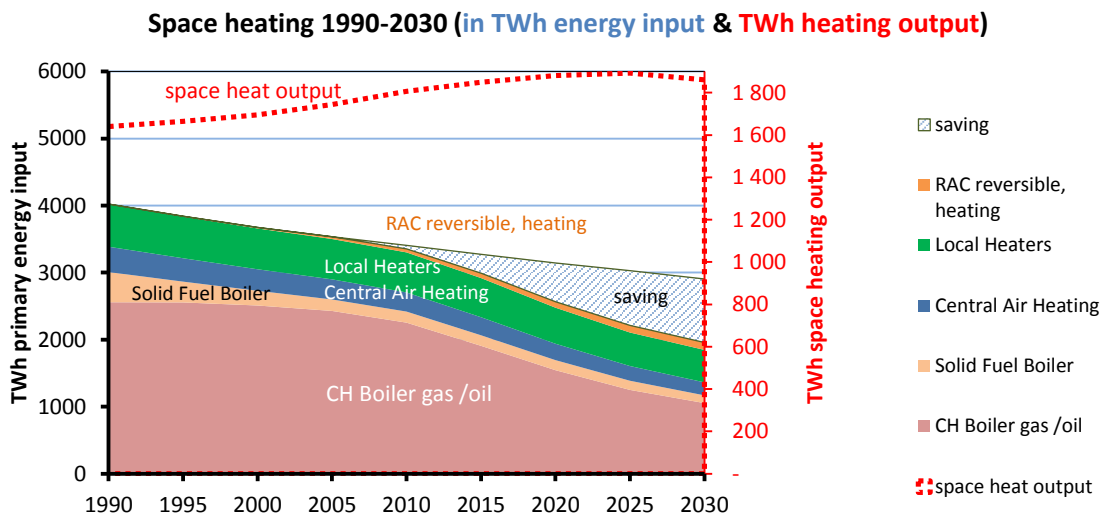

Figure 21. Space heating energy input (left Y-axis) and heat output (right Y-axis), total EU 1990-2030 according to EIA. Note that the scale of both Y-axes is not the same. (source: VHK, EIA report 1, 2014)

As regards the absolute values, the EIA report indicates a heating load of 1801 TWh in 2010 and 1881 TWh in 2020. The underlying study indicates, with all its uncertainties, a heat load of 2019 TWh in

<sup>81</sup> Source: Daikin Europe, Activity Report 2012/2013

<sup>82</sup> Based on an annual growth rate of 2-3%, which over 10 years leads to a CAGR (Compound Annual Growth Rate) of 22-35%.

2010 and an expects 1950 TWh in 2020. These are differences of 11 and 4% respectively, which amongst others indicate a convergence.

Following the approach in the previous chapter it is proposed to only make changes to the category of central heating boilers, increase the heat load for 2020 by 4% and increase the 2020 efficiency of the stock also by 4%, i.e. from 74% to 76%.

Assuming the convergence to continue, from 2026 there will be no difference in heat load and thus efficiency.

The values to be changed in the Ecodesign Impact Accounting spreadsheet relate to the load per unit (LOAD sheet) efficiency of the sales (EFNBAU and EFNECO sheets). The latter is shown in the graph below. The full calculation and the new values are given in the spreadsheet (MS Excel format).

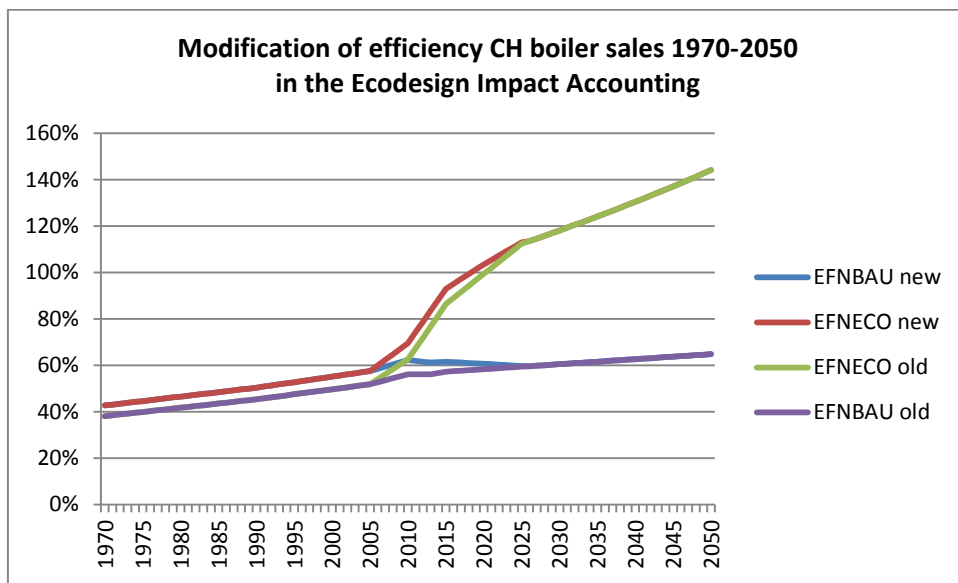

Figure 22. Modification of the efficiency for CH boiler sales 1970-2050 in the Ecodesign Impact Accounting

The consequences of this modification for the projected savings in the EIA report are minor. It means that in 2020 there will be 27 TWh less savings from Ecodesign and labelling measures concerning space heating. This is 4.7% less than previously calculated (553 versus 580 TWh/a).

The total projected savings, including the new space heating figures, is 0.3% less in 2020 (1904 versus 1932 TWh/a). With reference to 1990 this means that the saving in 2020 is not 19% but 18.7%.

For later years the differences are similar. A full calculation is given in the spreadsheet. It is recommended to implement the changes in the EIA report Part 2, which is due in March 2005.

## 8 SPACE COOLING

### 8.1 Introduction

Although in theory the modelling of space cooling could be similar to that for space heating, there are several reasons why space cooling is treated separately.

Firstly, the need for space cooling is very much a local issue, meaning that the total EU demand should be derived from the accumulated data of individual countries and cities. While for space heating load of the EU building stock it is possible to derive meaningful data from the average EU-wide temperatures, for space cooling this is not the case. Later in this paragraph some estimates are given, but overall the level of uncertainty is high.

Secondly, the comfort level –i.e. the desired indoor temperature in the cooling season—is very much a level of local habits, legislation and economics.

- The air-conditioning industry and installers traditionally are considering that in a building the ‘ideal’ indoor temperature of 19-20 °C should be maintained in the cooling season. Discounting for internal and solar gains, this means that the base outdoor temperature at which the air conditioning should start to operate at an outdoor air temperature of 15-16 °C.
- This philosophy can also be found in the test and calculation standards for space cooling, as well as for existing Ecodesign and energy labelling legislation for air conditioners, where the base temperature is a rounded 16 °C (real 15.5 °C) as is shown in the bin-hour table for cooling<sup>83</sup> below.
- In psychometrics it is found that only beyond 24-25 °C a majority of people experience thermal discomfort (‘too hot’). This is, in (often Nordic) countries where such stipulations exist, also the reason why legislation on labour conditions stipulate this as a limit value for the office work ambient.
- Some countries, like China and France, restrict the use of active cooling up to 25 °C in public buildings.<sup>84</sup> Also NGOs and other stakeholders take that view<sup>85</sup>. The argumentation appears to be that if most people are comfortable doing (light) work at an indoor temperature range up to 25 °C, why then should active space cooling be allowed at lower temperatures. It consumes energy, contributes significantly to an electricity ‘summer peak’ (and thus power plant capacity), it creates situations where –in some buildings—the cooling and heating systems are both active and –although there may be many people that think 19 °C is ‘ideal’—there will also be people wearing heavy sweaters in the summer to deal with the air-conditioning temperatures in the office and/or fall ill from the continuous cold air movement.

<sup>83</sup> The heating side was already mentioned in chapter 3

<sup>84</sup> Chinaview, State Council: no lower than 26 degrees in air-conditioned rooms, 2007-06-03, (source: [http://news.xinhuanet.com/english/2007-06/03/content\\_6192841.htm](http://news.xinhuanet.com/english/2007-06/03/content_6192841.htm))

France: Art. R. 131-29 of the construction law on operation of cooling systems. In all rooms equipped with a cooling system, the system should not be working for operative temperatures below 26 °C. (source: Armines, ENTR Lot 6 preparatory study, 2012)

<sup>85</sup> See [www.ecoheatcool.org](http://www.ecoheatcool.org) and [www.euroheat.org](http://www.euroheat.org). Report: Heat & Power, The European Cold Market, Ecoheatcool WP2, 2006. Uses 22 °C as a base outdoor temperature, which –with solar gains—leads to temperatures of 25 °C. According to this source.

Thirdly, there are some different opinions on the role of latent heat, on top of the sensible heat, contributing to the cooling load. In the preparatory study on Central Air Conditioners, Armines<sup>86</sup> shows that –depending on the location and the base level of absolute humidity set—the latent heat from condensation of inlet air can deliver a significant contribution to the space cooling load. This is particularly true at low indoor set temperatures; at indoor set temperatures of 25 °C the influence is minor (see paragraph 8.3).

Finally, any estimate of EU space cooling load in actual space cooling energy consumption is volatile, because relatively subjective behavioural and economical aspects play a major role. Especially in the residential sector it is difficult to predict what the final demand will be, because for large parts of the moderate EU climate residential air conditioners are luxury goods, where acquisition and use depend more on (lack of) spending power of the local inhabitants. Furthermore, the fact that the cooling season largely coincides with the holiday season may –especially in Southern Europe—severely influence the actual use of residential air conditioning installation and –to a lesser degree—workplaces and shops that will be closed.

## 8.2 Outdoor temperature and cooling season

Table 26 gives the most recent monthly cooling degree days (CDD) of EU capital cities for a base temperature (without threshold) of 20.5 °C. This is based on the estimate that in the 90 day (2100 h) cooling season the internal gain will add 1.5 °C<sup>87</sup> and the solar gain –after shading—will contribute approximately 3 °C<sup>88</sup>. In other words, these cooling degree days are expected to be representative of the times when the indoor temperature will be 25 °C or higher.

The outcome is an EU population-weighted total of 242 CDD. Over a 90 day cooling season this would amount to a representative outdoor temperature of 23.2 °C and an expected indoor temperature of 27.7 °C. Compared to the indoor reference temperature this is a temperature difference of 2.7 °C. If we include some 10% for latent heat, the indoor/outdoor temperature difference would become 3 °C.

In Table 27 the bin-hour profile of the Ecodesign and labelling regulations for room air conditioners is given. Bin-hours start, as mentioned, from a base temperature of 16.5 °C and find that there are 2602 hours during which the (rounded) temperature is in the range of 17 to 40 °C. The hour-weighted average temperature is 23 °C, which is close to what was found in the previous table, albeit at a higher number of hours.

<sup>86</sup> Armines et al., Lot 6: Air-conditioning and ventilation systems (Ecodesign preparatory study), Task 3 and 4 reports on air conditioning, 2012.

<sup>87</sup> Compare: In the heating season, with higher lighting and water heating energy use, the internal gains are expected to contribute 2.3 °C (See Chapter 3).

<sup>88</sup> This is also the average solar load assumed in the Ecoheatcool project. Ibid.76. Compare: in the heating season (Apr.-Oct.) the solar gain was expected to add 1.2 °C on average.



**Table 26. EU28 Capitals, Cooling Degree Days (CDD) at base outdoor temperature 20.5 °C (means ~25 °C indoor, incl. internal gains 1.5 K, solar gains and heat island 3 K), Aug. 2013-July 2014.**

(sources: www.degreedays.net, extract August 2014; VHK data elaboration)

City, weather station	2013					2014							TOTAL	popu- lation %	
	Aug	Sep	Oct	Nov	Dec	Jan	Feb	Mar	Apr	May	June	July			
AT Wien, Schwechat	85	7	0	0	0	0	0	0	1	11	44	65	213	1.6%	
BE Brussels, Zaventem	27	9	0	0	0	0	0	0	0	3	11	34	84	2.1%	
BG Sofia, Observ.	123	29	8	0	0	0	0	1	1	13	37	63	275	1.4%	
CY Larnaca, Cyprus	256	161	71	31	0	0	0	7	25	53	151	217	972	0.1%	
CZ Prague, Ruzyně	37	3	0	0	0	0	0	0	0	5	23	48	116	1.9%	
DE Berlin, Tempelhof	45	4	0	0	0	0	0	0	0	13	27	79	168	18.4%	
DK Copenhagen	10	0	0	0	0	0	0	0	0	1	2	44	57	1.2%	
EE Tallinn, Tallinn	12	0	0	0	0	0	0	0	0	14	4	48	78	0.3%	
EI Dublin, Dublin	0	1	0	0	0	0	0	0	0	0	1	3	5	0.7%	
ES Madrid, Barajas	208	96	16	1	0	0	0	2	22	40	103	164	652	7.0%	
FI Helsinki, Vantaa	15	1	0	0	0	0	0	0	0	15	6	60	97	1.2%	
FR Paris, Orly	48	15	1	0	0	0	0	0	0	2	20	52	138	13.3%	
GR Athens, Elefsis	265	135	33	5	0	0	0	1	9	57	156	232	893	1.9%	
HR Zagreb, Pleso	107	17	5	0	0	0	0	2	2	20	57	67	277	0.7%	
HU Budapest / Ferihegy	113	8	2	0	0	0	0	0	1	16	57	85	282	2.0%	
IT Roma, Ciampino	165	58	20	1	0	0	0	0	1	11	78	86	420	12.4%	
LI Vilnius, Vilnius	24	1	0	0	0	0	0	0	1	15	5	59	105	0.6%	
LT Riga, Airport	21	1	0	0	0	0	0	0	0	16	6	58	102	0.4%	
LU Luxembourg, LU	27	10	0	0	0	0	0	0	0	2	24	40	103	0.1%	
MT Valetta, Luqa	204	128	86	10	0	0	0	0	2	22	107	155	714	0.1%	
NL Amsterdam Schiphol	22	6	0	0	0	0	0	0	0	3	6	38	75	3.6%	
PL Warsaw, Mazowieckie	66	2	0	0	0	0	0	0	3	22	25	98	216	6.9%	
PO Lisbon, Rudela	106	74	16	0	0	0	0	1	4	23	42	58	324	1.8%	
RO Bucuresti / Imh	150	32	3	1	0	0	0	1	3	26	54	109	379	3.4%	
SE Stockholm (Arlanda)	15	2	0	0	0	0	0	0	0	8	2	54	81	2.1%	
SI Liubljana, Brnik	85	10	0	0	0	0	0	0	0	9	41	42	187	0.3%	
SK Bratislava, Ivanka	96	8	1	0	0	0	0	0	2	16	56	81	260	1.3%	
UK London, Heathrow	25	9	0	0	0	0	0	0	0	3	13	44	94	13.2%	
<b>EU Total CDD</b>	<b>81</b>	<b>25</b>	<b>5</b>	<b>0</b>	<b>0</b>	<b>0</b>	<b>0</b>	<b>0</b>	<b>2</b>	<b>13</b>	<b>38</b>	<b>77</b>	<b>242</b>	<b>100.0%</b>	
EU Average cooling season outdoor temperature at base 20.5 °C and 90 day cooling season, in °C														<b>23.2</b>	
EU Average cooling season indoor temperature (including 4.5 K internal and solar gains), in °C														<b>27.7</b>	
EU Average cooling season temperature difference ΔT with reference 25 °C, in °C														<b>2.7</b>	

**Table 27. Cooling season bin-hour profile, Delegated Regulation 626/2011 (room air conditioners, OJ L 178, 6.7.2011, p. 1)**

bin-nr #	temperature °C	hours h	bin-nr #	temperature °C	hours h
1	17	205	13	29	88
2	18	227	14	30	63
3	19	225	15	31	39
4	20	225	16	32	31
5	21	216	17	33	24
6	22	215	18	34	17
7	23	218	19	35	13
8	24	197	20	36	9
9	25	178	21	37	4
10	26	158	22	38	3
11	27	137	23	39	1
12	28	109	24	40	0
		<b>total</b>			<b>2602</b>
		<i>average (calc. VHK)</i>			<b>23.0</b>

### 8.3 Latent heat

Note that the regulations do not explicitly take into account humidity levels. Also the Ecoheatcool project considers the humidity levels not to have an important influence. Table 28 below, from the ENTR Lot 6 study, shows for the 3 climate references that the base temperature and thus the base absolute temperature play a crucial role in this respect: At a base temperature of 15 °C (the ‘traditional approach’) the contribution of the latent heat is very significant, but at a base temperature of 20 °C its influence is negligible.

**Table 28. Cooling degree days for different ambient base conditions (Armines, based on IWECC data, 2011)**

Location	T <sub>base</sub> = 15°C and W <sub>base</sub> = 0.0106 kg <sub>w</sub> /kg <sub>da</sub>			T <sub>base</sub> = 20°C and W <sub>base</sub> = 0.0147 kg <sub>w</sub> /kg <sub>da</sub>		
	SCDD (sensible CDD)	LCDD (latent CDD)	TCDD (total CDD)	SCDD (sensible CDD)	LCDD (latent CDD)	TCDD (total CDD)
Strasbourg (France)	393	161	554	57	1	59
Athens (Greece)	1678	295	1973	765	1	766
Helsinki (Finland)	123	7	131	4	0	4

### 8.4 Modelling outcome for space cooling demand

With the above parameters it is now possible, similar as for heating in Chapter 6, to calculate the space cooling load, but now with a cooling season of 2100h and an indoor/outdoor temperature difference ΔT of 3 °C. All other parameters, i.e. geometry, insulation and ventilation rates, are assumed as for heating.

The total cooling load with the equation from Chapter 2:

$$Q_{\text{building}} = 0.001 \cdot \Delta T_{\text{cooling}} \cdot t_{\text{cooling}} \cdot [ S \cdot U + V \cdot q \cdot (1-\text{rec}) \cdot c_{\text{air}} ]$$

becomes

$$Q_{\text{building}} = 0.001 \cdot 3 \cdot 2100 \cdot [ 48.8 \cdot 0.93 + 114.1 \cdot 0.86 \cdot (1-0.04) \cdot 0.343 ] \approx 490 \text{ TWh} \approx 1.8 \text{ EJ}^{89}$$

This would suggest, that the EU space cooling load is some 17% of the total space heating load (in TWh primary energy).

### 8.5 Comparison to Ecodesign Impact Accounting and trend

In the Ecodesign Impact Accounting study, based on the preparatory studies for Lot 10 (Room Air Conditioners) and ENTR Lot 6, the EU space cooling load being served by air conditioners in 2010 was established at 220 TWh, with 164 TWh for (mainly tertiary sector) central air conditioning and 56 TWh for (mainly residential) room air conditioners. This would imply that currently less than half of the potential space cooling demand is covered.

<sup>89</sup> Actual values are 489.3 TWh and 1761 PJ (Eta Joule: 1EJ = 1000 PJ).

The same source predicts that in 2020 the central air conditioners would cover a load of 209 TWh (+27%) and room air conditioner load would almost double at 96 TWh, bringing the total to 305 TWh (+38%). Reportedly, the tertiary sector demand would then more or less stagnate, whereas –albeit at a slower pace—residential space cooling demand would continue to increase. In 2030 the total EU space cooling load would be +352 TWh (+15% versus 2020).

The graph below gives the trend of the space cooling output delivered (the ‘load’, dotted purple line). It also shows the primary energy input (TWh electricity x 2.5<sup>90</sup>) for the Business-as-Usual scenario and the savings from Ecodesign measures (the ‘Eco’ scenario). Under the Eco-scenario the primary energy consumption for space cooling would remain at a level of 180 TWh primary energy (72 TWh electricity), despite the increase in output.

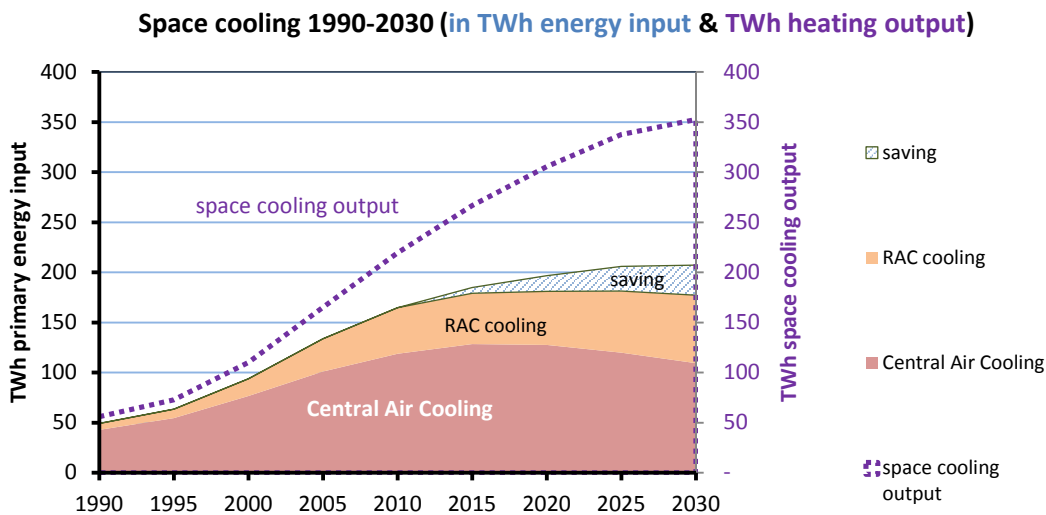

Figure 23. Space cooling energy input and cooling output (source: VHK, EIA report 1, 2014)

## 8.6 Conclusions space cooling

There are considerably more uncertainties in estimating EU space cooling demand than in estimating EU space heating demand, because non-technical factors play a major and largely unpredictable role. Nevertheless, the order of magnitude of the figures that could be retrieved, i.e. a (partially to be fulfilled) demand of 490 TWh, is in line with what was found in the Ecodesign Impact Accounting study. Therefore, no correction of the load figures in the Ecodesign Impact Accounting study is foreseen.

<sup>90</sup> 2.5 is the primary energy factor (the reverse of the 40%) for the EU electricity generation.

## REFERENCES

- AEA, Lot 11 - Circulator pumps (<2.5 kW), Ecodesign preparatory study for EC DG ENER, Feb. 2008
- Aleksandra Arcipowska, Buildings Performance Institute Europe (BPIE), Making European Buildings Data useful for policy making process, Contribution to European Data Forum, Athens, Greece (19-20 March 2014).
- Armines, ENTR Lot 6 -Central Air Cooling >12 kW, Ecodesign preparatory study for EC DG ENTR, Sept. 2011
- Armines, Lot 10- RAC Room Air Conditioner (<12 kW) & comfort fans, Ecodesign preparatory study for EC DG ENER, March 2009
- AUMA report 2009.
- BIOIS, Lot 20 - Local Heaters, Ecodesign preparatory study for EC DG ENER, June 2012
- BIOIS, Lot 21 - Central Air Heating, Ecodesign preparatory study for EC DG ENER, July 2012
- BIOIS/AEA, Lot 15 -Solid Fuel Boilers, Ecodesign preparatory study, Jan. 2010
- BPIE Building Performance Institute Europe (policy research institute). See [www.bpie.eu](http://www.bpie.eu)
- Brandsma, T. and D. Wolters (KNMI), Measurement and statistical modeling of the urban heat island of the city of Utrecht (the Netherlands), *Journal of Applied Meteorology and Climatology*, 2012, 51, 1046-1060, doi:<http://dx.doi.org/10.1175/JAMC-D-11-0206.1>.
- BRG Consult, London. Pers. Comm. 2013.
- Buildings Performance Institute Europe (BPIE), Europe's buildings under the microscope, A country-by-country review of the energy performance of buildings, Oct. 2011.
- Bundesministerium für Verkehr, Bau und Stadtentwicklung, 'Typologie und Bestand beheizter Nichtwohngebäude in Deutschland', BMVBS-Online-Publikation, Nr. 16/2011, Aug. 2011.
- Bundesministerium für Verkehr, Bau und Stadtentwicklung, 'Typologie und Bestand beheizter Nichtwohngebäude in Deutschland', BMVBS-Online-Publikation, Nr. 16/2011, Aug. 2011.
- Bundesministerium für Verkehr, Bau und Stadtentwicklung, 'Typologie und Bestand beheizter Nichtwohngebäude in Deutschland', BMVBS-Online-Publikation, Nr. 16/2011, Aug. 2011.
- Chairman of the NL 'College van procureurs-generaal', Harm Brouwer, 22.11.2009, TV programme Buitenhof
- Diez, K.. Benchmarking im Krankenhaus
- EC Staff working document Impact Assessment report for Circulator pumps (<2.5kW), SEC(2009)1016
- EC Staff working document Impact Assessment report for Room air conditioners, SWD(2012)35
- EC Staff working document Impact Assessment report for Space heaters and combination heaters, SWD(2013)297
- EC, Energy Performance Building Directive 2010/31/EU.
- ECN, Data hotels, report 2008 with data 2007 on the Netherlands (average EU internet density): 1.6 TWh. EU=30xNI à 48 TWh. Of this 22% went into HVAC
- Ecofys for Eurima, various research reports 2007 - 2014, see <http://www.eurima.org>
- Ecofys, Panorama of the European non-residential construction sector, Final Report, by order of the Copper Institute (Leonardo ENERGY initiative), 2011.
- EEA, Climate change, impacts and vulnerability in Europe 2012, European Environmental Agency, 2013
- EN ISO 13790:2008, Thermal performance of buildings - Calculation of energy use for space heating and cooling.
- EN15221-6:2010, Facility Management - Part 6: Area and Space Measurement in Facility Management.

Energy Follow-Up Survey 2011, Report 2: Mean household temperatures, Prepared by BRE on behalf of the Department of Energy and Climate Change, December 2013, BRE report number 283078

EnEV (Germany), SAP (UK), RT (France), EPG (Netherlands), etc..

ENTRANZE. Policies to ENforce the TRAnsition to Nearly Zero Energy buildings in the EU-27. Project co-funded by the Intelligent Energy Europe programme of the EU. See <http://www.entranze.eu> .

EPISCOPE. Energy Performance Indicator Tracking Schemes for the Continuous Optimisation of Refurbishment Processes in European Housing Stocks. Project co-funded by the Intelligent Energy Europe programme of the EU (2013-2016). See [www.episcope.eu](http://www.episcope.eu)

European Commission, IA guidelines, 2009. See:

[http://ec.europa.eu/comm/secretariat\\_general/impact/docs/SEC2005\\_791\\_IA\\_guidelines\\_main.pdf](http://ec.europa.eu/comm/secretariat_general/impact/docs/SEC2005_791_IA_guidelines_main.pdf). Annex to IA guidelines: [http://ec.europa.eu/governance/impact/docs/SEC2005\\_791\\_IA\\_guidelines\\_anx.pdf](http://ec.europa.eu/governance/impact/docs/SEC2005_791_IA_guidelines_anx.pdf)

Eurostat 2009, crim\_plce

Eurostat 2009, crim\_prsn

Eurostat NUTS classification. NUTS 1: major socio-economic regions (e.g. country or region); NUTS 2: basic regions for the application of regional policies (e.g. province); NUTS 3: small regions for specific diagnoses (e.g. arrondissement). See also [http://epp.eurostat.ec.europa.eu/portal/page/portal/nuts\\_nomenclature/introduction](http://epp.eurostat.ec.europa.eu/portal/page/portal/nuts_nomenclature/introduction).

Eurostat Yearbook 2009.

Eurostat, Energy Balance. Editions 1991-2011.

Eurostat, Regional Yearbook, 2013.

Finance Minister of Baden-Württemberg, Drucksache 12 / 4784, Stromsparen in Landesgebäuden durch Modernisierung der Lüftungsanlagen, 20. 01. 2000.

Hamdi, Rafiq (Koninklijk Meteorologisch Instituut), Estimating Urban Heat Island Effects on the Temperature Series of Uccle (Brussels, Belgium) Using Remote Sensing Data and a Land Surface Scheme, Remote Sensing, 10.12.2010, 2, pp. 2773-2784.

[http://www.engineeringtoolbox.com/metabolism-clothing-activity-d\\_117.html](http://www.engineeringtoolbox.com/metabolism-clothing-activity-d_117.html)

IEA Sustainable Buildings Centre, <http://www.sustainablebuildingscentre.org>

IGDG 'Gianni De Giorgio', Italian climate data set for energy calculations of buildings.

IWEC files, International Weather for Energy Calculations, publicly available through Energy Plus. See [http://apps1.eere.energy.gov/buildings/energyplus/weatherdata\\_sources.cfm](http://apps1.eere.energy.gov/buildings/energyplus/weatherdata_sources.cfm)

JRC-IPTS, Minutes from VHK-IPTS meeting 5 Feb. 2014.

JRC-Ispra PVGIS (<http://re.jrc.ec.europa.eu/pvgis/apps4/pvest.php#>)

Kemna, R.B.J., Ecodesign Impact Accounting – Part 1, VHK for European Commission, Specific contract ENER/C3/412-2010/FV575-2012/12/SI2.657835, June 2014.

Kemna, R.B.J., et al., Methodology for Ecodesign of Energy-related Products, VHK for European Commission, Nov. 2011. See [http://ec.europa.eu/enterprise/policies/sustainable-business/ecodesign/methodology/index\\_en.htm](http://ec.europa.eu/enterprise/policies/sustainable-business/ecodesign/methodology/index_en.htm)

Nawal Al-Hosany, Energy Management and Façade Design in Prison Buildings in Hot Climates: The Case Of Abu Dhabi, Research Paper, 2000.

NORDREGIO, Mountain Areas in Europe, European Commission contract, Final Report, Jan. 2004.

OECD Health Data 2012

Olivier Cantat, L'îlot de chaleur urbain parisien selon les types de temps - Weather types and Urban Heat Island in Paris, NOROIS revue, 2004/2, p. 75-102.

Poli, T. et al. (Politecnico di Milano BEST/ Osservatorio Meteorologico di Milano Duomo), The influence of the urban heat island over building energy demand: The case of Milan, paper at the 7th International Conference of Urban Climate, 29 June – 3 July 2009, Yokohama, Japan.

Report to Congress on Server and Data Center Energy Efficiency Public Law 109-431 U.S. Environmental Protection Agency ENERGY STAR Program, August 2, 2007.

RGD Jaarverslag 2009, the Netherlands.

Richter, M. et al., Observed Changes in Long-Term Climatic Conditions and Inner-Regional Differences in Urban Regions of the Baltic Sea Coast, Atmospheric and Climate Sciences, 2013, 3, 165-176.

Sobrino, J.A. et al. (University of Strasbourg, France), Evaluation of the surface urban heat island effect in the city of Madrid by thermal remote sensing, International Journal of Remote Sensing, 2013, Vol. 34, Nos. 9-10, pp. 3177-3192.

Statistisches Bundesamt, 20 Jahre Krankenhausstatistik, Feb. 2012

TABULA: Typology Approach for Building Stock Energy Assessment. Project co-funded by the Intelligent Energy Europe programme of the EU (2009-2012, predecessor of EPISCOPE). See episcopes website as a portal.

Teubner Verlag: Baumanagement und Bauökonomie (Ch. 4.6 Bemessung von Gebäuden):

VHK, Ecodesign Impact Accounting - Part 1, Brussels/Delft, 7.6.2014.

VHK, ENTR Lot 6 - Non-residential ventilation units, Ecodesign preparatory study for EC DG ENTR, June 2012.

VHK, Lot 1 - CH Boilers, Ecodesign preparatory study for EC DG ENER, Sept. 2007.

VHK, Methodology for the Ecodesign of Energy-related Products, MEErP, Methodology Report Part 1: Methods, , Brussels/ Delft, 28.11.2011

VHK, Methodology for the Ecodesign of Energy-related Products, MEErP, Methodology Report Part 2: Environmental policies & data, VHK, Brussels/ Delft, 28.11.2011

VHK/ ift Rosenheim/ VITO, Lot 32 – Windows, Ecodesign preparatory study for EC DG ENTR, Draft Task 2 and 3 reports, Feb. 2014.

Zelfstandig Bestuursorgaan for Dutch Ministry of Social Affairs, Kerngegevens (2008)

## ANNEX A : HEATING DEGREE DAYS POPULATION-WEIGHTED

Table A1. header:

Heating degree-days by NUTS 2 regions - annual data 2009

*[source: VHK calculation on the basis of Eurostat, nrg\_esdgr\_a ; demo\_r\_d3area; table population density NUTS 2 level]; EU average calculated by surface and by population density. Note that population data are derived from multiplication of these latter 2 parameters and may be subject to rounding errors]*

Note:

Apart from a minor deviation of 21 HDD, due to incomplete NUTS 2 surface data, the calculation shows that indeed the 2009 Eurostat's number of average EU heating days (3076 HDD) is based on a surface-weighted average. The same dataset recalculated –at NUTS 2 level—for a population weighted average yields an EU average of 2637 HDD, i.e. 14% lower.

AVERAGE EU BUILDING HEAT LOAD FOR HVAC EQUIPMENT

NUTS 2 area (excl. overseas)	heating degree days	surface (km <sup>2</sup> )	density (inhab/km <sup>2</sup> )	population (inhab)	NUTS 2 area (excl. overseas)	heating degree days	surface (km <sup>2</sup> )	density (inhab/km <sup>2</sup> )	population (inhab)
<b>EU</b>					<i>Germany (continued)</i>				
EU27 Eurostat (source)	3 076				Lüneburg	2 975	15 508	109	1695024
EU28 surface-weighted (calc.)	<b>3 055</b>				Weser-Ems	2 823	14 986	165	2477235
EU28 population weighted (calc.)	<b>2 637</b>				Düsseldorf	2 651	5 290	980	5181947
<i>total/avg.</i>		<i>4387462</i>	<i>118</i>	<i>516 m</i>	Köln	2 834	7 365	595	4384883
<b>Belgium</b>					Münster	2 765	6 908	377	2601628
Région de Bruxelles-Capitale	2 487	161	6702	1079038	Detmold	2 961	6 520	314	2046628
Prov. Antwerpen	2 560	2 867	623	1784708	Arnsberg	3 002	8 003	461	3687644
Prov. Limburg (BE)	2 584	2 422	349	845520	Koblenz	2 953	8 073	185	1495101
Prov. Oost-Vlaanderen	2 505	2 982	484	1443884	Trier	2 978	4 923	105	514443
Prov. Vlaams-Brabant	2 486	2 106	511	1075955	Rheinhessen-Pfalz	2 783	6 851	294	2010886
Prov. West-Vlaanderen	2 548	3 144	370	1161708	Saarland	2 849	2 569	400	1026453
Prov. Brabant Wallon	2 519	1 090	346	377249	Chemnitz (NUTS 2006)	3 355	6 524	206	1344555
Prov. Hainaut	2 617	3 786	347	1311849	Dresden	3 139	7 931	205	1624269
Prov. Liège	2 899	3 862	277	1068615	Leipzig (NUTS 2006)	2 975	3 965	252	998708
Prov. Luxembourg (BE)	3 011	4 440	60	268176	Sachsen-Anhalt	3 005	20 447	116	2369819
Prov. Namur	2 831	3 666	129	471814	Schleswig-Holstein	3 073	15 799	179	2832761
<b>Bulgaria</b>					Thüringen	3 231	16 172	140	2259242
Severozapaden	2 464	19 070	48	909653	<b>Estonia</b>				
Severen tsentralen	2 350	14 974	61	919404	Eesti	4 302	45 227	31	1397514
Severoiztochen	2 252	14 487	68	989489	<b>Ireland</b>				
					Border, Midland and				
Yugoiztochen	2 116	19 799	57	1118627	Western	2 909	33 252	37	1243625
Yugozapaden	2 711	20 306	104	2113896	Southern and Eastern	2 781	36 545	90	3278087
Yuzhen tsentralen	2 459	22 365	69	1534246	<b>Greece</b>				
<b>Czech Republic</b>					Anatoliki Makedonia, Thraki	1 792	14 157	43	610167
Praha	3 209	496	2558	1268619	Kentriki Makedonia	1 750	19 147	103	1975970
Strední Cechy	3 209	11 015	115	1263421	Dytiki Makedonia	2 247	9 451	32	299597
Jihozápad	3 427	17 618	71	1247319	Thessalia	1 572	14 037	53	738346
Severozápad	3 363	8 649	135	1167615	Ipeiros	1 768	9 203	39	361678
Severovýchod	3 409	12 440	123	1531389	Ionia Nisia	1 123	2 307	101	233699
Jihovýchod	3 223	13 991	121	1697096	Dytiki Ellada	1 230	11 350	67	762720
Strední Morava	3 302	9 230	135	1247923	Stereia Ellada	1 299	15 549	36	558209
Moravskoslezsko	3 314	5 426	235	1275747	Peloponnisos	1 240	15 490	38	591718
<b>Denmark</b>					Attiki	1 029	3 808	1077	4101216
Denmark	3 235	43 098	130	5610106	Voreio Aigaiio	1 038	3 836	52	200623
<b>Germany</b>					Notio Aigaiio	552	5 286	58	308174
Stuttgart	3 021	10 558	379	4003442	Kriti	727	8 336	73	610195
Karlsruhe	2 881	6 919	396	2740616	<b>Spain</b>				
Freiburg	3 005	9 357	235	2196111	Galicia	1 834	29 574	93	2759292
Tübingen	3 277	8 918	203	1807638	Principado de Asturias	1 894	10 604	100	1061420
Oberbayern	3 187	17 531	248	4340552	Cantabria	1 984	5 321	110	583747
Niederbayern	3 240	10 330	115	1191037	País Vasco	1 974	7 235	297	2148131
Oberpfalz	3 301	9 691	112	1082440	Com. Foral de Navarra	1 947	10 390	60	619268
Oberfranken	3 390	7 232	149	1079663	La Rioja	2 061	5 045	63	315836
Mittelfranken	3 189	7 245	236	1711175	Aragón	1 983	47 720	28	1321852
Unterfranken	3 051	8 532	155	1324957	Comunidad de Madrid	1 863	8 028	793	6368374
Schwaben	3 353	9 993	179	1785731	Castilla y León	2 235	94 226	27	2515832
Berlin	2 998	891	3858	3437122	Castilla-la Mancha	1 774	79 462	26	2042173
Brandenburg	3 062	29 480	85	2517566	Extremadura	1 224	41 635	27	1107478
Bremen	2 905	404	1637	661839	Cataluña	1 796	32 113	228	7325067
Hamburg	3 013	755	2348	1773285	Comunidad Valenciana	1 294	23 255	217	5036925
Darmstadt	2 864	7 445	509	3788659	Illes Balears	919	4 992	215	1074713
Gießen	3 149	5 381	195	1046624	Andalucía	1 074	87 598	95	8277983
Kassel	3 210	8 289	148	1228400	Región de Murcia	1 086	11 313	129	1454878
Mecklenburg-Vorpommern	3 138	23 182	72	1657542	Ciudad Autón. de Ceuta (ES)	431	20	3815	74398
Braunschweig	3 041	8 100	200	1619920	Ciudad Autón. de Melilla	562	13	5317	71242
Hannover	2 911	9 047	237	2145996					



AVERAGE EU BUILDING HEAT LOAD FOR HVAC EQUIPMENT

NUTS 2 area (excl. overseas)	heating degree days	surface (km <sup>2</sup> )	density (inhab/km <sup>2</sup> )	population (inhab)	NUTS 2 area (excl. overseas)	heating degree days	surface (km <sup>2</sup> )	density (inhab/km <sup>2</sup> )	population (inhab)
<b>France</b>					Észak-Magyarország	2 751	13 433	91	1215659
Île de France	2 436	12 012	979	11757639	Észak-Alföld	2581	17729	85	1498075
Champagne-Ardenne	2 654	25 606	52	1336623	Dél-Alföld	2468	18337	72	1322119
Picardie	2 615	19 400	99	1912791	<b>Malta</b>				
Haute-Normandie	2 573	12 317	149	1835293	Malta	499	316	1310	413992
Centre (FR)	2 378	39 151	65	2544809	<b>Netherlands</b>				
Basse-Normandie	2 446	17 589	84	1472224	Groningen	2887	2960	247	729936
Bourgogne	2 531	31 582	52	1642264	Friesland (NL)	2827	5748	193	1110649
Nord - Pas-de-Calais	2 520	12 414	325	4035824	Drenthe	2857	2680	186	497750
Lorraine	2 766	23 547	100	2350031	Overijssel	2818	3420	339	1160369
Alsace	2 636	8 280	223	1844001	Gelderland	2715	5136	401	2061277
Franche-Comté	2 752	16 202	72	1169806	Flevoland	2729	2412	272	656387
Pays de la Loire	2 174	32 082	111	3554663	Utrecht	2655	1449	878	1272165
Bretagne	2 184	27 208	117	3186045	Noord-Holland	2721	4091	995	4071341
Poitou-Charentes	2 078	25 810	68	1765370	Zuid-Holland	2629	3418	1241	4243042
Aquitaine	1 849	41 308	78	3217924	Zeeland	2502	2933	213	625801
Midi-Pyrénées	2 119	45 348	63	2870522	Noord-Brabant	2656	5081	496	2521589
Limousin	2 431	16 942	44	742073	Limburg (NL)	2656	2209	522	1153202
Rhône-Alpes	2 582	43 698	142	6200775	<b>Austria</b>				
Auvergne	2 826	26 013	52	1344867	Burgenland (AT)	2693	3961.8	77	306247
Languedoc-Roussillon	1 989	27 376	96	2622602	Niederösterreich	3054	19186	85	1628917
Provence-Alpes-Côte d'Azur	2 164	31 400	156	4895198	Wien	2764	414	4274	1772042
Corse	1 063	8 680	35	307265	Kärnten	3353	9538	60	570372
<b>Croatia</b>					Steiermark	3327	16401	74	1218594
Croatia	2 316	87 661	93	8143707	Oberösterreich	3231	11980	120	1442380
<b>Italy</b>					Salzburg	3610	7156	75	537416
Piemonte	2 266	25 403	179	4536887	Tirol	3680	12640	56	712907
Valle d'Aosta/Vallée d'Aoste	3 164	3 263	39	128570	Vorarlberg	3403	2601	145	377940
Liguria	1 823	5 422	303	1643287	<b>Poland</b>				
Lombardia	2 288	23 863	429	10239527	Lódzkie	3372	18219	140	2545194
Bolzano/Bozen (NUTS 2006)	3 868	7 400	68	503193	Mazowieckie	3516	35558	147	5212803
Trento (NUTS 2006)	3 404	6 207	85	528207	Malopolskie	3454	15183	217	3293193
Veneto (NUTS 2006)	2 232	18 399	279	5129613	Slaskie	3342	12333	377	4643375
Friuli-Venezia Giulia (NUTS 2006)	2 243	7 858	163	1281705	Lubelskie	3503	25122	86	2160492
Emilia-Romagna (NUTS 2006)	2 008	22 446	198	4446454	Podkarpackie	3348	17846	118	2100474
Toscana (NUTS 2006)	1 763	22 994	164	3773233	Swietokrzyskie	3431	11711	109	1271815
Umbria (NUTS 2006)	1 981	8 456	109	920013	Podlaskie	3800	20187	59	1191033
Marche (NUTS 2006)	1 820	9 366	167	1566915	Wielkopolskie	3296	29826	114	3403147
Lazio (NUTS 2006)	1 625	17 236	335	5767166	Zachodniopomorskie	3345	22892	74	1694008
Abruzzo	1 850	10 763	126	1352871	Lubuskie	3136	13988	72	1009934
Molise	1 744	4 438	73	325283	Dolnoslaskie	3305	19947	144	2876357
Campania	1 433	13 590	435	5904942	Opolskie	3235	9412	110	1032496
Puglia	1 415	19 358	213	4117425	Kujawsko-Pomorskie	3452	17972	115	2068577
Basilicata	1 561	9 995	61	606672	Warminsko-Mazurskie	3668	24173	59	1426207
Calabria	1 171	15 081	136	2053978	Pomorskie	3537	18310	122	2224665
Sicilia	1 093	25 711	198	5101142	<b>Portugal</b>				
Sardegna	1 139	24 090	70	1686293	Norte	1652	21284	176	3745966
<b>Cyprus</b>					Algarve	715	4996	87	432154
Kypros	600	9 250	87	802900	Centro (PT)	1241	28200	85	2382908
<b>Latvia</b>					Lisboa	765	2940	961	2825142
Latvija	4 161	64 559	36	2343492	Alentejo	877	31551	24	754074
<b>Lithuania</b>					<b>Romania</b>				
Lietuva	3 931	65 300	53	3480490	Nord-Vest	2861	34161	81	2760168
<b>Luxembourg</b>					Centru	3174	34100	75	2550658
Luxembourg	2 967	2 586	193	497805	Nord-Est	3094	36850	103	3791844
<b>Hungary</b>					Sud-Est	2534	35762	91	3236434
Közép-Magyarország	2 598	6 916	425	2938566	Sud - Muntenia	2552	34453	98	3372949
Közép-Dunántúl	2 643	11 116	99	1100474	Bucuresti - Ilfov	2491	1821.2	1283	2337328
Nyugat-Dunántúl	2 655	11 328	88	996890	Sud-Vest Oltenia	2579	29212	79	2310645
Dél-Dunántúl	2 539	14 169	67	950720	Vest	2577	32033	61	1950822

AVERAGE EU BUILDING HEAT LOAD FOR HVAC EQUIPMENT

<b>NUTS 2 area (excl. overseas)</b>	<b>heating degree days</b>	<b>surface (km<sup>2</sup>)</b>	<b>density (inhab/km<sup>2</sup>)</b>	<b>population (inhab)</b>	<b>NUTS 2 area (excl. overseas)</b>	<b>heating degree days</b>	<b>surface (km<sup>2</sup>)</b>	<b>density (inhab/km<sup>2</sup>)</b>	<b>population (inhab)</b>
<b>Slovenia</b>									
Slovenija	2 774	20 273	104	2114474	South Western Scotland	3 240	13 060	175	2290636
<b>Slovakia</b>					Highlands and Islands	3 316	38 957	11	440211
Bratislavský kraj	2 697	2 053	302	619710	Northern Ireland (UK)	3 009	14 150	126	1788598
Západné Slovensko	2 857	14 993	125	1866591					
Stredné Slovensko	3 373	16 263	83	1349846					
Východné Slovensko	3 288	15 728	101	1582267					
<b>Finland</b>									
Itä-Suomi (NUTS 2006)	5 492	179 375	23	4161488					
Etelä-Suomi (NUTS 2006)	4 692	35 704	165	5901888					
Länsi-Suomi	5 021	64 764	36	2357417					
Pohjois-Suomi (NUTS 2006)	6 210	57 000	6	364800					
Åland	4 178	1 582	18	28152					
<b>Sweden</b>									
Stockholm	4 017	6 789	307	2082927					
Östra Mellansverige	4 121	41 414	40	1664839					
Småland med öarna	3 922	35 560	24	864115					
Sydsverige	3 481	14 424	98	1419312					
Västsverige	3 846	31 108	63	1966045					
Norra Mellansverige	4 957	69 549	13	897182					
Mellersta Norrland	5 669	77 207	5	401476					
Övre Norrland	6 322	165 296	3	545475					
<b>United Kingdom</b>									
Tees Valley and Durham	3 221	3 026	387	1170302					
Northumberland and Tyne and Wear	3 236	5 516	255	1408837					
Cumbria	3 190	6 823	73	499429					
Greater Manchester	3 025	1 276	2040	2602785					
Lancashire	2 894	3 076	470	1447092					
East Yorkshire and Northern Lincolnshire	2 777	3 519	261	918329					
North Yorkshire	3 067	8 312	96	796309					
South Yorkshire	2 855	1 552	849	1317534					
West Yorkshire	3 040	2 029	1098	2227563					
Derbyshire and Nottinghamshire	2 839	4 788	435	2084739					
Leicestershire, Rutland and Northamptonshire	2 731	4 918	341	1677496					
Lincolnshire	2 711	5 921	118	698631					
Herefordshire, Worcestershire and Warwickshire	2 807	5 898	216	1270976					
Shropshire and Staffordshire	2 920	6 204	246	1523180					
West Midlands	2 764	902	2927	2638532					
East Anglia	2 643	12 570	187	2349314					
Bedfordshire and Hertfordshire	2 714	2 879	591	1701769					
Essex	2 580	3 677	469	1724654					
Inner London	2 461	319	9580	3058990					
Outer London	2 478	1 254	3744	4696226					
Berkshire, Buckinghamshire and Oxfordshire	2 737	5 743	388	2227865					
Surrey, East and West Sussex	2 555	5 456	492	2682170					
Hampshire and Isle of Wight	2 604	4 149	451	1870090					
Kent	2 449	3 737	446	1668152					
Gloucestershire, Wiltshire and Bristol/Bath area	2 675	7 471	312	2330236					
Dorset and Somerset	2 613	6 105	203	1236202					
Cornwall and Isles of Scilly	2 484	3 566	150	534558					
Devon	2 687	6 710	170	1139324					
West Wales and The Valleys	2 801	12 058	145	1744749					
East Wales	2 794	8 721	145	1261042					
North Eastern Scotland	3 490	6 498	63	406144					
Eastern Scotland	3 376	17 951	111	1994312					

## ANNEX B: EU LAND COVERAGE 2012 (LUCAS)

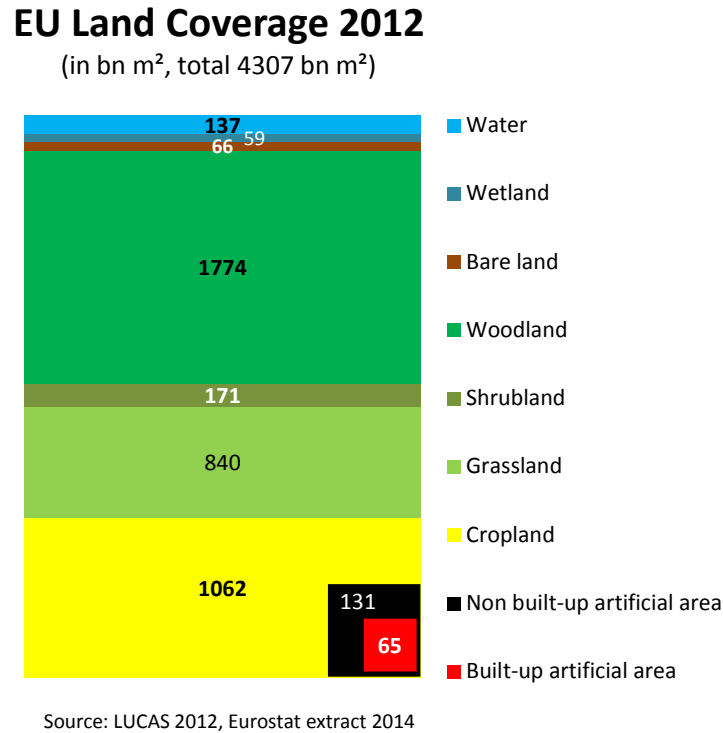

**Figure B.1.** EU Land Coverage 2012, according to LUCAS.

LUCAS estimates the built-up artificial area at 65 billion m<sup>2</sup> (1.5% of total), but this part of the assessment is still in its infancy and would require a grid size that is much more refined than today. Compare: According to the data in this report, the ground floor area of the heated buildings is in the range of 10 billion m<sup>2</sup>. To this the floor area (or rather roof area) of unheated buildings and constructions has to be added, but it seems unlikely to add up to the LUCAS number.

## ANNEX C: EVALUATION BUILDING VOLUME ACCURACY, GERMANY

The German federal building ministry BMVBS<sup>91</sup> has looked into several methods to estimate the number and dimensions of the non-residential building stock for Germany. The table below gives a qualitative evaluation. The main conclusion from this evaluation is that the indirect derivation from national statistics (land registry, building permits) is the most useful source, although at a limited aggregation level and subsequently with a considerable margin of error in floor area and volume.

Direct statistics on functional units (hospital beds, sports facilities, etc.) at least supply numbers for parts of the categories. The urban planning guidelines on e.g. type and number of shops per area could be useful for part of the trade buildings. The GIS (Geographic Information Systems) are only – partially-- useful to identify buildings that are clearly set apart from the general urban landscape, such as schools, hospitals, sports and cultural buildings. Finally, the BMVBS concludes that there are still several areas that are not covered in their building categories and where at the moment only anecdotal information (case studies, reference buildings) can help.

**Table C.1. Evaluation of methods to assess the number of non-residential buildings in Germany (source: BMVBS 2011)**

Category	GIS	Guidelines	Statistics direct	Statistics indirect
Educational buildings	○1	-	○4	■
Offices and public buildings	-	-	○5	■
Factories	-	-	-	■ <sub>g</sub>
Workshops	-	-	-	■ <sub>g</sub>
Health care facilities	○	-	○6	-
Trade buildings	-	○	-	■ <sub>g</sub>
Warehouses	-	-	-	■ <sub>g</sub>
Sports buildings	■	-	■	-
Indoor swimming pools	-	-	-	-
Cultural buildings	○3	-	-	■
	-	-	○7	■

- = numbers can be assessed
- = numbers can partially be assessed
- = numbers cannot be assessed
- 1 only maternal, primary & secondary schools and higher education
- 2 only hospitals
- 3 cinemas, tradefair, exposition buildings are missing
- 4 children's daycare and vocational training facilities are missing
- 5 only court buildings, i.e. the largest part is missing
- 6 only hospitals, polyclinics missing
- 7 companies and enterprises are captured, not buildings
- 8 factories and repairshops are only given as a total number
- 9 trade buildings and warehouses are only given as a total number

The same source also shows quantitative comparisons of the number and the floor area of non-residential buildings according to various sources. These are given in the graphs below, which show that deviations of  $\pm 30\%$  from a middle value of the sources are quite common.

<sup>91</sup> Bundesministerium für Verkehr, Bau und Stadtentwicklung, 'Typologie und Bestand beheizter Nichtwohngebäude in Deutschland', BMVBS-Online-Publikation, Nr. 16/2011, Aug. 2011.

Furthermore, it is relevant that this wide range of possible error applies to Germany, i.e. one of the Member States with probably –along with the Scandinavian countries–the most detailed and accurate building statistics in the European Union.

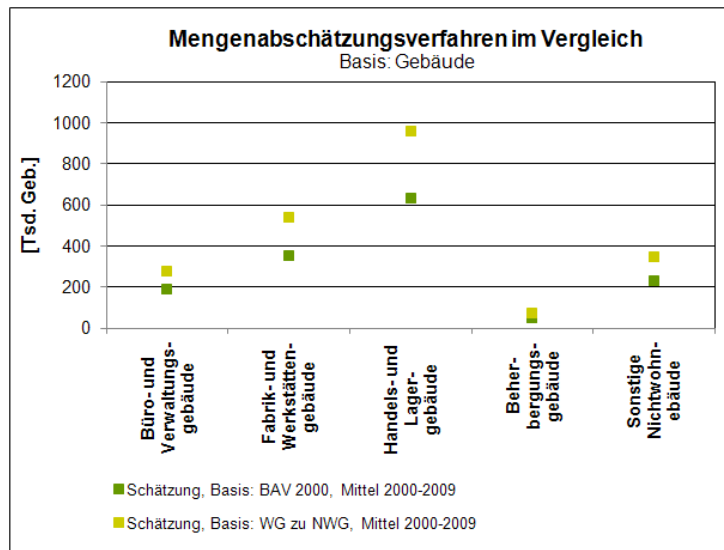

Figure C.1. Comparison of number of buildings by various sources

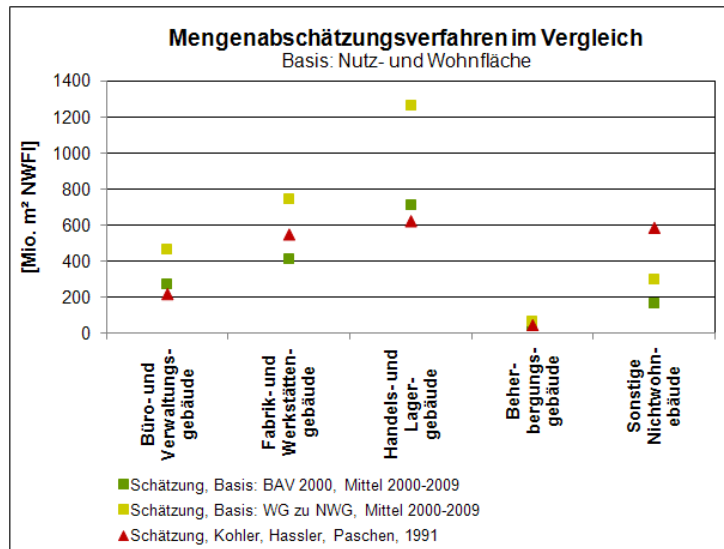

Figure C.2. Comparison of useful floor area by various sources

Sources for these comparative graphs are the official statistics ('BAV'), an estimate on the basis of the analogy between residential and non-residential buildings ('WG zu NGW', see figure XXX) and the results from a comprehensive (but older) study by Kohler, Hassler, Paschen for the year 1991 (see Table XXX).

Note: The building volume in the figure below relates to gross volume, i.e. including outer walls/roof/floors but also including circulation areas and technical functional spaces. The surface area in table below relates to useful floor area, i.e. excluding outer walls/roof/floors, circulation areas and technical functional spaces.

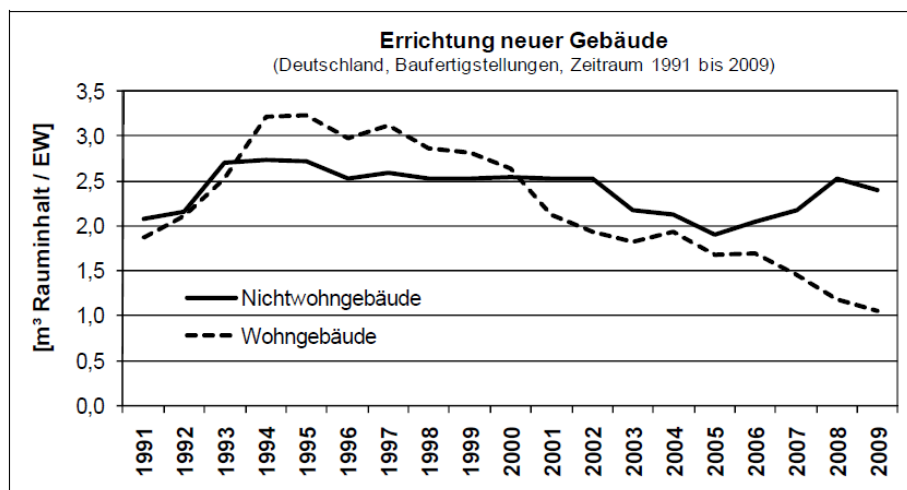

Figure C.3. Comparison of newly built (*Errichtung neuer Gebäude*) non-residential building (*Nichtwohngebäude*) with residential (*Wohngebäude*) volume (*Rauminhalt*) per inhabitant (*EW=Einwohner*) in Germany 1991-2009 as a basis for estimating non-residential building stock volume.

Table C.2. Useful area (D. Nützfläche) of German building stock 1991 in million m<sup>2</sup> (source: Kohler, Hassler, Paschen 1999)

age class	till 1870	till 1918	till 1948	till 1965	till 1978	till 1990	Share
<b>Function class</b>							
single family houses	105	168	159	275	252	196	47%
terraced houses	13	20	50	87	108	56	13%
small multi-family houses	74	119	124	260	194	116	28%
large multi-family houses	17	27	12	47	92	45	11%
high rise apartment buildings	0	0	0	10	36	6	1%
<b>Total residential buildings</b>	<b>209</b>	<b>334</b>	<b>345</b>	<b>679</b>	<b>683</b>	<b>418</b>	<b>2668=100%</b>
office and public buildings	20	51	31	44	36	35	12%
health care buildings	26	64	38	55	26	11	4%
hotels and restaurants	4	11	7	9	7	6	2%
trade buildings and warehouses	61	153	92	131	100	87	29%
factory, workshop buildings	54	135	81	115	88	77	26%
agricultural buildings	52	131	79	112	53	45	15%
other non-residential buildings	66	164	98	137	86	36	12%
<b>Total non-residential buildings</b>	<b>283</b>	<b>708</b>	<b>425</b>	<b>603</b>	<b>396</b>	<b>298</b>	<b>2713=100%</b>
<b>Total buildings</b>	<b>492</b>	<b>1 042</b>	<b>770</b>	<b>1 282</b>	<b>1 079</b>	<b>716</b>	<b>5 381</b>

## ANNEX D: FUNCTIONAL UNITS, CAPITA SELECTA

Source: VHK, MEErP-2011, Part 2

Note that these figures are not yet updated to EU28-2010, but they are the basis for the update

### Residential sector (2010)

The residential dwelling stock increases at 1.1% annually (1.16% built minus 0.06% demolition). New dwellings have 107.5 m<sup>2</sup> floor area, existing dwellings 90 m<sup>2</sup> (2010). Growth rate of the dwelling floor area is 0.6%/a (2010). There are 4.6 rooms per dwelling (2010) with an annual increase of 0.4%. Figures are based on updates of VHK, Ecodesign preparatory study on CH boilers, for ENER Lot 1, 2007. Subsequent studies have shown minor deviations (mentioned at the respective figures later in this chapter, e.g. for retail and defence buildings), but the overall estimate seems robust.

In EU-27 there are 144 million single family/duplex dwellings in 115 million buildings. Average dwelling size is estimated at 110 m<sup>2</sup>/dwelling. Total floor area is estimated at 15.8 bln. m<sup>2</sup>. At an average floor height of 2.85 m the built volume will be 45 bln. m<sup>3</sup>. Around 80% are conventional occupied homes in permanent use (ca. 115 million 'primary dwellings' typically with 1 household/dwelling)

24 % of primary dwellings have whole-house mechanical ventilation, 22.5% mechanical exhaust and 1.5% balanced ventilation with heat recovery. The rest has natural ventilation, with or without the aid of local fans.

118 million multi-family dwellings (44% of the residential sector), of which ca. 80% (94 million) are occupied, used permanently and equipped with a heating system;

14.7 million multi-family buildings have a total floor area of ca. 10.5 bln. m<sup>2</sup>, including dwellings at 65 m<sup>2</sup>/unit and a multiplier 1.25 for entrance, stairs, elevators, service area, indoor parking in a part of city apartments;

At an average floor height of 3 m (high share of older buildings), the built volume will be around 30 bln. m<sup>3</sup>, of this the permanently occupied dwellings (heated and ventilated) represent 6.3 bln. m<sup>2</sup> and 18.8 bln. m<sup>3</sup>;

Around 80% are conventional occupied dwellings in permanent use (ca. 94 million 'primary dwellings' typically with 1 household/dwelling). Together with single family/duplex dwellings this brings the estimate of the number of EU-27 households on around 209 million. At an EU-27 population of over 501 million inhabitants (Eurostat, status 1.1.2010) this means an average household size of 2.4 persons per household.

Of the primary dwellings (80% of stock) 64% are 'low-rise' (60 million; 12 bln. m<sup>3</sup>), i.e. with 4 layers or less, situated in the equivalent of 10 million buildings. Typically they are assumed to be city apartments with side-walls attached to a neighbouring apartment. The AV ratio of the building will

be  $0.55 \text{ m}^2/\text{m}^3$ . Per dwelling the ground- and top apartments will have a significantly higher AV-ratio (ca. 0.7) and the mid-apartments a lower AV-ratio (ca. 0.3).

70% of these low-rise apartments use natural ventilation (42 million dwellings;  $8.3 \text{ bln. m}^3$ ), 28% are using central mechanical exhaust ventilation ( $16.8 \text{ mln}$ ;  $3.35 \text{ bln. m}^3$ ) and 2% ( $1.2 \text{ million}$ ;  $0.24 \text{ bln. m}^3$ ) balanced mechanical ventilation system. Of this latter group half may have heat recovery ventilation systems (1%,  $0.11 \text{ bln. m}^3$ ).

Average EU-27 multi-family building: 8 flats/ building

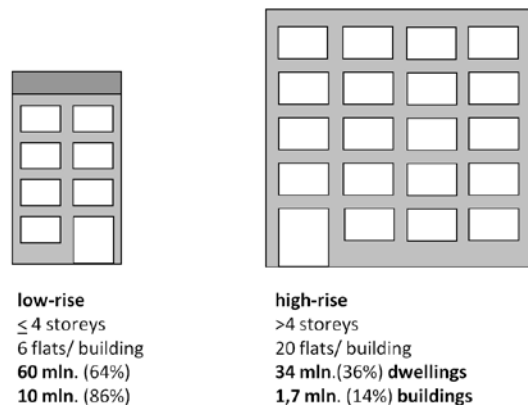

Figure D.1. Split-up of number and types of apartment building EU-27 (2005)

36% of primary apartments (34 million dwelling;  $6.6 \text{ bln. m}^3$ ) are ‘high-rise’, i.e. with 5 layers or more, situated in the equivalent of 1.7 million buildings. Typically they will be peripheral flats. The AV ratio of the building will be  $0.65 \text{ m}^2/\text{m}^3$ . Per dwelling the corner, ground- and top apartments will have a significantly higher AV-ratio (ca. 0.7) and the mid-apartments a lower AV-ratio (ca. 0.3).

50% of these high-rise apartments use natural ventilation, with passive stacks for the wet rooms ( $15 \text{ million}$ ;  $2.9 \text{ bln. m}^3$ ) and 48% are using central mechanical exhaust ventilation, largely from retrofitting the passive stacks ( $14.4 \text{ million}$ ;  $2.9 \text{ bln. m}^3$ ). Again 2% of these apartments ( $0.6 \text{ mln}$ ;  $0.1 \text{ bln. m}^3$ ) may have a balanced mechanical ventilation system, possibly with cooling. Of this latter group half may have heat recovery ( $0.3 \text{ million}$ ;  $0.05 \text{ bln. m}^3$ ).

### Residential sector demographics (2005)

In 2005, the EU-25 had 456 million inhabitants and was hardly growing ( $0.15\%/year$ ). In some countries like Italy, Portugal, Hungary, the Czech Republic and the Baltic States the population is expected to decrease. Fastest grower was Ireland, which expected 18% more inhabitants in 15 years from now (data 2005).

The number of households, where ‘household’ may have slightly different definitions per Member State but in general is equal to the number of primary dwellings, is growing faster, i.e. at around 1%



### Residential sector physical characteristics (2005)

Boverket reports an EU-25 stock of 205 million dwellings in 2003, of which 19% in Germany, 14% in France, 13% in Italy, 12% in the UK and 10% in Spain. If we also include Poland (6%), there are 6 countries that make up three quarters of the EU-25 dwelling stock. The other countries each make up 3.3% (NL) or less of the total.

Primary dwellings, the principle dwellings where families live, are around 184 million. Around 20.5 secondary dwellings are reported which represent a heterogenous mix of second homes, vacant homes, etc..

Germany does not include vacant homes in its dwelling stock, whereas most countries do.

- France<sup>92</sup> includes hotels in its dwelling stock figure.
- Ireland, France and Poland also include mobile dwellings such as ships and/or permanent caravans (US. 'trailers').

Collective homes are reportedly included in the dwelling stock statistics of Belgium, Cyprus, Lithuania, Luxembourg, Poland and Sweden. This could have a negative effect on the primary dwelling stock, because these dwellings house multiple households.

With the possible exception of Spain, the reported figures on the stock of second homes, winter and summer habitations, etc. after subtraction of the vacant homes are very unlikely. Despite the efforts of Boverket this will probably remain a grey area.

Vacant homes, waiting to be sold, renovated or demolished, are the most substantial part of what is reported as 'secondary homes'. In 2003 some 18 million homes were identified as such. If we exclude the German vacant homes, we find that almost 15 out of the 20 million 'secondary homes' are in fact 'vacant homes'. The remainder are mostly second homes reported by Spain, whereas of course also in many other countries there is a vast –but not reported—stock of weekend/winter/summer cottages.

Single- and two family homes account for 54% of the dwelling stock and multi-family homes for 46%, of which some 16% are high rise buildings with more than 4 storeys. In some countries, notably Germany, a distinction is made in the statistics between single-family and two-family houses, where the latter are slightly less than half of the total. But some countries just count two-family dwellings as (semi-detached) single family homes. Please note that the figures represent the number of dwellings (not the number of buildings).

The EU-25 built some 2.2 million new dwellings in 1990 and in 2003. Effectively, given the rise in population and the smaller household size this means that there has been a negative growth rate in many countries, notably in Germany (-16% ), Baltics (around -75%), Scandinavia (>-50%), whereas also in Slovakia, Czech Republic and Hungary the new 2003 dwellings are only half of what they were in 1990. The most dramatic increases took place in Ireland (+245%) and in Spain (+63%).

---

<sup>92</sup> and in principle also Poland, but the figure presented in the table only includes primary dwellings.

Reporting on demolished dwellings is incomplete, so the figure of 133000 dwellings removed from the 2003 stock is a minimum figure.

The largest fraction of older buildings in the EU-25 can be found in the UK, Denmark, France and Italy, where buildings from before 1919 make up 19-21% of the total stock.

These countries also have the highest average dwelling age of 56-57 years. The youngest building stock can be found in Portugal and Finland (33 years), followed by Ireland, Spain and Greece (35 years). The Netherlands has relatively built the most new dwellings (30% of total) in the period since 1981.

The average EU floor area for existing dwellings is 87 m<sup>2</sup> or 35 m<sup>2</sup>/person. For new dwellings this is 103 m<sup>2</sup> per dwelling. The largest existing houses can be found in Cyprus (145 m<sup>2</sup>), Luxembourg (125), Denmark (109) and Ireland (106). The smallest existing dwellings (avg. 55-60 m<sup>2</sup>) can be found in the Baltic States and some countries in Central Europe. However, new dwellings in the Baltics and Central Europe are on or above the EU-average.

Existing dwellings have approx. 4 rooms per dwelling, whereas new dwellings have 4.5. This excludes the hall(s), cellars, etc.. Whether the kitchen is counted as a 'room' depends on the country. Many countries use a definition with a minimum number of square meters. Austria, Denmark, France and Lithuania do not usually count the kitchen as a room. From the number of rooms the number of heat emitters can be estimated to be 6-7 heat emitters per dwelling (including the hall and 2-3 radiators in living room + kitchen).

Around 78-79% of the dwelling stock—or some 160 million dwellings—are reported to have some form of central heating (wet/dry/district) and running hot water for showers or baths. In friendly climates like Malta (3%), Portugal (4%), Cyprus (27%) the occasional stove is probably enough for space heating. For hot water we find the lowest penetration (60-70%) in the Baltic States and Portugal. In general, the reliability of these figures should not be overrated because it is usually left to the imagination of the people filling in a questionnaire to determine whether they have 'central heating' or not.

### **Residential dwellings heat loads (2005)**

Figures are based on outcomes of more recent studies in 2005 on the subject of the average heat load per dwelling and revisiting every aspect of earlier studies (PRIMES 'Shared Analysis' 1999, SAVE 2002, ECCP 2003). It tries to reconcile a 'bottom-up' and 'top-down' approach in not only correcting the EU-average, but also making an estimate per Member State.

The average EU-25 space heating/cooling energy demand is currently around 12.600 kWh/dwelling. This is 72.5% of the total average net energy demand (excl. power generation losses) of 17370 kWh/dwelling.

Of this, the effective heating/cooling load of the dwelling (transmission, ventilation, internal gains at current comfort level) is 7.400 kWh/dwelling.

Both of the above points combined imply that around 40% of the space heating demand is due to heating system losses (generator, distribution and control losses).

Per unit of floor area the 7.400 kWh/hh.a heat load equals around 85 kWh/m<sup>2</sup> or a little over 300 MJ/m<sup>2</sup>. In Southern Europe this is half (Italy 54, Spain 37, Greece 69 kWh/m<sup>2</sup>, etc. ) and in Northern Europe this is double that value (Estonia 186, Finland 158, Sweden 118, etc.). But the climate certainly doesn't explain all differences, e.g. the highest calculated heat loads per dwelling can be found in the middle of the EU, i.e. in Luxemburg (15.400 kWh/hh.a) and Belgium (12.200 kWh/hh.a).

Statistical information on housing characteristics has improved, but we are still a long way from being able to monitor efficiency improvements in the housing stock.

The figures per individual Member State should be understood as an attempt to test the average EU heat load data for consistency, not as the best possible estimate of the residential energy balance for each individual Member State. This would require a higher level of differentiation between e.g. generator, distribution and control losses in each country and a more extensive study. Having said that, the accuracy of the EU average heat load is estimated at within  $\pm 10\%$ , which is sufficient for our purpose.

### **Retail (2006-2010)**

There is a trend towards more (indoor) shopping malls in the EU. In 2005, the Retail Consulting Group, already predicted 150 m<sup>2</sup>/1 000 inhabitants. Today, this may be around 200 m<sup>2</sup>/1 000 inhabitants. At a typical size of 100.000 m<sup>2</sup> per mall this means 2 large malls per million inhabitants or rather around 1 000 large shopping malls in Europe. This represents the equivalent of 100 million m<sup>2</sup>. Every mall holds around 100-150 retail outlets, already taken into account above and representing one third of the volume, but it still means that 66 million m<sup>2</sup> (264 million m<sup>3</sup>) is unaccounted for, which has to be added to the above total.

This brings the retail total to around 4.264 million m<sup>3</sup>. Including wholesale and trade in motor vehicles the total becomes 6.760 m<sup>3</sup>.

### **Hotels & restaurants (2006)**

Eurostat (2006) reports for the EU-27 a capacity of in total 25 million beds/places, subdivided between 11 million hotel beds, 9 million places on tourist camp-sites, 2.5 million holiday dwellings and 2.2 other collective accommodations.

### **Trade Fairs**

In terms of the size of the buildings, the trade fair exhibition halls are an interesting subsection at NEC 5-digit level. Germany alone boosts 2.7 million m<sup>2</sup> of trade fair exhibition hall floor area. In total EU-27 is estimated to have ca. 10 million m<sup>2</sup> of trade fair exhibition area. At a ceiling height of 8 m this comes down to ca. 80 million m<sup>3</sup>. Largest 5 fairs in EU are: Hannover, Milano Fiera, Frankfurt, Cologne, Dusseldorf.<sup>93</sup>

### **Transportation and communication (2009)**

It is estimated that the EU has around 10.000 manned train stations, i.e. featuring at least one heated area. The size of the heated area may range from a one-man ticket counter to the arrivals &

---

<sup>93</sup> AUMA report 2009. Note that in Belgium, the Brussels Exhibition Park (114.000 m<sup>2</sup> hall area) is the largest. In NL this is Jaarbeurs (100.000 m<sup>2</sup>).

departures hall of an international high speed rail station. As a first guess, the heated area is estimated at 200 m<sup>2</sup>, including the company head-offices. This brings the total to 2 million m<sup>2</sup> and around 8 million m<sup>3</sup>.

There are around 25 large cities in the EU that feature a subway-network. Per network, around 100 underground stations are estimated, which require ventilation. In total, these 2.500 underground stations will have a floor area of 2.5 million m<sup>2</sup> and a total ventilated volume of **5 million m<sup>3</sup>**.

The CIA World Factbook reports 3.376 airfields in the EU (2009), of which 1.981 with a paved runway and presumably some heated area. Of the latter it is estimated that around 200-300 airports host commercial flights, of which again around 30 large airports. Estimating the latter at 200.000 m<sup>2</sup> (2 million m<sup>3</sup>, excluding shops) a piece, 250 other commercial airports at 2 000 m<sup>2</sup> (10 000 m<sup>3</sup>) and 1600 small airports at 200 m<sup>2</sup> (1000 m<sup>3</sup>) per unit, the total is around 64 million m<sup>3</sup>.

For harbour buildings (port authorities, waiting hall ferry's etc.) , in as much as they are not already taken into account under the heading 'wholesale', it is difficult to make an accurate estimate. A figure of 3 million m<sup>3</sup> is given.

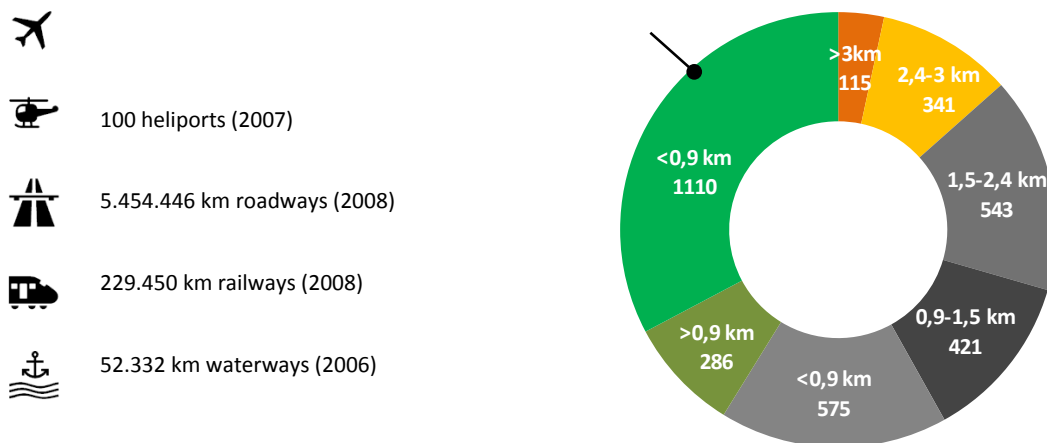

Figure D.2. Selected EU transportation characteristics (source: CIA World Factbook 2009)

Statistics on post offices are extremely volatile, given the trends of privatisation, internet and mix of mail services with other activities (banking, shops). A very rough estimate is that typical mail activities of larger mail-offices can be partitioned to around 20 million m<sup>3</sup> gross floor area in the EU.<sup>94</sup>

<sup>94</sup> Basis of estimate: NL still has 250 'larger' main-offices. EU=30xNL. At 1000 m<sup>2</sup>/building for specific mail-linked activities this gives 7.5 mln. m<sup>2</sup> (20 mln. m<sup>3</sup>). Note that NL has around 1.850 mail-offices mixed with shops (headcount is under 'retail').

Computer and telephone data centres (a.k.a. ‘server farms’) accounted for 61.4 TWh of electricity consumption in the US in 2006.<sup>95</sup> At the same time, the energy use in the EU-27 was lagging some 20% behind<sup>96</sup>, but it is assumed that today the EU-27 will have the same 10-11 million servers installed as the US and will also be spending some 60 TWh/a on data centres. Of this, 22% (13.2 TWh/a) is attributed to air-conditioning and ventilation. In principle, this type of air-conditioning and cooling is outside the scope of this study, because it concerns process-cooling and not comfort cooling (no people). But the figure is important enough to mention here, because it can explain 1-2% of total HVAC stock of chillers or AHU’s. At an ICT heat dissipation of 1 kW/m<sup>2</sup> floor area, 45 TWh/a ICT electricity use, 8.000 h operation, a ceiling height of 3.5 m, the data centres represent around 6 million m<sup>2</sup> of gross floor area and 20 million m<sup>3</sup>, but the cooling performance is of course much higher than for comfort cooling.

Note that the ventilation of tunnels and parking garages<sup>97</sup>, as well as the ventilation and conditioning of motor vehicles, trains, ships and aircraft can constitute considerable energy consumption.

### Financial institutions (2007)

Belga (2007) reports an average density of 1 EU bank branch office per 2.230 inhabitants. At 500 million inhabitants this means 220.000 bank branch offices in the EU. At an estimated average of 200 m<sup>2</sup> (800 m<sup>3</sup>) per office (including ATM area, including head-office) this comes down to a heated volume of 180 million m<sup>3</sup>.

### Health care (2010)

Ventilation is set high, not only due to the actual heated floor area, but also influenced by certain specific activities like laboratories, operating theatre and treatment areas that require up >10 times the usual ventilation fold.

In the EU-28 (2010) there are 2.7 million hospital beds.<sup>98</sup> There are 3.4 doctors per 1000 inhabitants--> 1.7 million doctors in EU<sup>99</sup>. In Germany there is 1.1 million staff (all types) for 0.67 hospital beds<sup>100</sup>.

A sample of 15 hospitals in Germany 2008 shows: 300 m<sup>2</sup>/bed and 85-100 MWh energy/bed for university clinics, 50-150 m<sup>2</sup> and 40 MWh per bed for other hospitals; 30% is electricity 105kWh/m<sup>2</sup>; 70% heating 250 kWh/m<sup>2</sup>; best <150 kWh/m<sup>2</sup>.<sup>101</sup>

Architect manual Germany: 43 m<sup>2</sup> Net floor area (NF) per hospital bed. [others: 15 m<sup>2</sup> NF/car parking garage, 29 m<sup>2</sup> NF/worker offices, 181 m<sup>2</sup> NF/firetruck in firefighting-station). Hospital conversion:

<sup>95</sup> Report to Congress on Server and Data Center Energy Efficiency Public Law 109-431 U.S. Environmental Protection Agency ENERGY STAR Program, August 2, 2007.

<sup>96</sup> ECN, Data hotels, report 2008 with data 2007 on the Netherlands (average EU internet density): 1.6 TWh. EU=30xNI → 48 TWh. Of this 22% went into HVAC

<sup>97</sup> The EU-27 has 5860 km of tunnels (CIA World Factbook data 1.1. 2009), including railroad (ca. 23%), subway(28%), road tunnels (49% of safety regulated km capacity). Regulated tunnels (>300 m) are on average ca. 1.2 km/tunnel long and account for ¼ of the total km. This means around 3660 tunnels with sufficient ventilation capacity to evacuate toxic fumes. Typical fan-values found are 2 supply fans (90 m<sup>3</sup>/s) and 2 exhaust fans (70 m<sup>3</sup>/s) per tunnel, amounting to a total of capacity of 320 m<sup>3</sup>/s or 1.15 mln. m<sup>3</sup>/h per tunnel. No data on part load operation are available.

<sup>98</sup> Eurostat Yearbook 2009.

<sup>99</sup> OECD Health Data 2012

<sup>100</sup> 20 Jahre Krankenhausstatistik, Statistisches Bundesamt, Feb. 2012

<sup>101</sup> Diez, K.. Benchmarking im Krankenhaus

$NF \cdot 1.72 = NGF$  (net floor area)  $\rightarrow 74 \text{ m}^2/\text{bed}$ .  $BGF = 74/0.86 = 86 \text{ m}^2$ .<sup>102</sup> The NGF, i.e. the heated floor area is around  $1.7 \cdot NF$ .

### Education (2006-2010)

In the EU there are approximately 550 larger universities with an average  $170.000 \text{ m}^2$  gross floor area and  $774.000 \text{ m}^3$  volume officially named universities<sup>103</sup>. The rest are institutes of Higher Education or comparable institutes (including around 250 small universities), assumed to have a gross floor area of around  $20.000 \text{ m}^2$  and  $90.000 \text{ m}^3$  volume.

In the EU-27 (2006) there were 93.9 million people enrolled in school (excluding pre-school), of which 28.5 million in primary school (ISCED 1), 22.9 million in lower secondary school (ISCED 2), 23.6 million in upper secondary and post-secondary non-tertiary school (ISCED 3 and 4) and 18.8 million in tertiary education (ISCED 5 and 6).<sup>104</sup>

Minimum gross floor area building standards per pupil/student (derived from NL and checked against anecdotal evidence from other EU countries) prescribe  $3.5\text{-}4 \text{ m}^2$  for primary schools,  $7\text{-}8 \text{ m}^2$  for secondary schools and on average  $9 \text{ m}^2$  for university. For ISCED levels 4 to 6, the ratio depends highly on the direction, e.g. as low as  $5 \text{ m}^2$  per law-student and up to  $40 \text{ m}^2$  per engineering student.

On the other hand, anecdotal evidence suggests that the floor area per pupil may also be as high as  $17\text{-}20 \text{ m}^2$  for primary schools<sup>105</sup> and  $40 \text{ m}^2$  for tertiary (technical) education.

Average floor height is assumed to be  $4.5 \text{ m}$ .

Apart from the institutions mentioned in section M, Ministry of Education has extra costs for subjects dealing with research and culture, e.g.

- national research laboratories ( $3.6$  million  $\text{m}^2$  floor area, but at high ventilation fold estimated at  $50$  million  $\text{m}^3/\text{h}$  at  $18 \text{ }^\circ\text{C}$ ), mainly classified under section K (code 73).
- core central ministry, classified under NACE section O (code 75), accounting for  $4$  million  $\text{m}^2$

<sup>102</sup> Teubner Verlag: Baumanagement und Bauökonomie (Ch. 4.6 Bemessung von Gebäuden):

<sup>103</sup> The Finance Minister of Baden-Württemberg (Drucksache 12 / 4784, 20. 01. 2000, Stromsparen in Landesgebäuden durch Modernisierung der Lüftungsanlagen ...) mentions  $1.9$  mln.  $\text{m}^2$  for  $1060$  university buildings and  $0.7$  mln.  $\text{m}^2$  for  $340$  university hospital buildings. Of this total of  $2.6$  mln.  $\text{m}^2$  it is estimated that  $910\,000 \text{ m}^2$  (35%) has an air-conditioning or ventilation provision (Raum Luft Technische RLT Anlage). This is equivalent to around  $530$  buildings with an estimated  $4$  'RLT-Anlagen' per building. Overall electricity consumption was estimated at  $38 \text{ GWh}$  (taken as  $0.53 \times 72 \text{ GWh}$ ). In total around 15% of these installations were renovated in the last 5 years. The German district ('Land') Baden-Württemberg has  $11$  universities, so on average this is  $172\,000 \text{ m}^2$  per university. District inhabitants total ca.  $10.8$  mln., which is ca. 2% of EU-27. Other anecdotal evidence: Rotterdam Erasmus university  $180\,000 \text{ m}^2$  ( $20.000$  students of law, economics, medicine). Gent university real estate  $771$  buildings and  $750\,000 \text{ m}^2$  total. Leiden University has  $70$  buildings with  $222\,000 \text{ m}^2$  floor area. Extreme cases are universities specialized in law, economics with much less  $\text{m}^2$  per student and there are technical universities with much more than average  $\text{m}^2$  per student. E.g. Delft technical university has around  $450\,000 \text{ m}^2$  gross floor area ( $12\,000$  students).

<sup>104</sup> Eurostat Yearbook 2009.

<sup>105</sup> Example Germany: model 'Passiv' school:  $8700 \text{ m}^2$ ,  $40\,347 \text{ m}^3$  for  $400$  primary school and  $100\text{-}125$  kindergarten,  $50$  staff. Heat recovery ventilation at a rate of  $21\,700 \text{ m}^3/\text{h}$ .

- national museums, classified under NACE section O (code 92.520)
- university clinics, classified under 'Health care', NACE section N (code 85.111)

### Justice (2006)

Courts of justice are the working place of around 50-60.000 judges and 120-150.000 other staff<sup>106</sup>. Gross floor area can be derived directly from central government statistics and will be around 15 million m<sup>2</sup>, which results in around 60 million m<sup>3</sup>.<sup>107</sup>

The EU-27 has around 0.6 million prisoners<sup>108</sup> and 0.28 million direct prison personnel.<sup>109</sup> Gross floor area per EU prisoner is around 70 m<sup>2</sup> for smaller prisons (<500 inmates)<sup>110</sup>, 56 m<sup>2</sup> for medium sized prisons (500-1000 inmates) and 36 m<sup>2</sup> for large prisons (>1000)<sup>111</sup>. At 56 m<sup>2</sup> per inmate the prison floor area is 33.6 million m<sup>2</sup> and at a floor height of 4 m the total volume is 135 million m<sup>3</sup>.

Other personnel on the Justice department budgets involves general management (100 000 staff<sup>112</sup>), immigration service (100 000 staff), state bailiffs service (25 000 staff), national forensics labs<sup>113</sup> (20 000 staff, 9 million m<sup>3</sup>), ICT and other support (15 000).<sup>114</sup> The ventilation need is estimated at around 30 million m<sup>3</sup>.

Eurostat reports that in 2006 the EU-27 police-force consists of 1.7 million police officers<sup>115</sup>. From national statistics it is estimated that the police force is supported by around 1 million technical and administrative staff and trainees.<sup>116</sup> In most countries police efforts are split between justice and defence department, but for the sake of clarity the 0.25-0.3 million paramilitary forces working as border police, coast guard and customs guards are classified as 'police' and have to be added to the 1.7 million staff reported by Eurostat. Statistics on heated gross floor area of buildings are scarce, but from anecdotal evidence a figure of 10 m<sup>2</sup> per person is estimated.<sup>117</sup> At around 3 million personnel this brings the total heated floor area to approximately 30 million m<sup>2</sup> and a volume of around 110 million m<sup>3</sup>. An archetype police station (small city) has around 800-1000 m<sup>2</sup> heated floor area. Building sizes ranges from <100 m<sup>2</sup> (small village) to >25.000 m<sup>2</sup> (regional head office or larger city).

<sup>106</sup> NL: 800 public defenders in NL (source: Chairman of the NL 'College van procureurs-generaal', Harm Brouwer, 22.11.2009, programme Buitenhof). EU=NLx30 → 24 000. Note that in some countries the denominations 'judge' and 'public defender' may be used differently.

<sup>107</sup> RGD Jaarverslag 2009: Courts of Justice NL 2009: 535.551 m<sup>2</sup> for ca. 4000 staff (ibid. 10) . In 2000 there were around 1700 judges in the Netherlands.

<sup>108</sup> Eurostat 2009, crim\_prsn

<sup>109</sup> CBS, Netherlands: 17 600 prisoners (2005), 9 447 direct prison personnel (on a total of 17 558 full time personnel for all types of penitentiary institutions).

<sup>110</sup> Typical for NL: RGD Jaarverslag mentions 1 265 460 m<sup>2</sup> for penitentiary institutions

<sup>111</sup> Nawal Al-Hosany, Energy Management and Façade Design in Prison Buildings in Hot Climates: The Case Of Abu Dhabi, Research Paper, 2000.

<sup>112</sup> RGD: Core departments 625 206 m<sup>2</sup> for 13 departments → ca. 50 000 m<sup>2</sup> per department.

<sup>113</sup> NFI, the Dutch Forensics Lab, employs 350 staff (+200 at central level), 28 000 m<sup>2</sup>, volume ca. 100 000 m<sup>3</sup>, but very high ventilation need at 300 000 m<sup>3</sup>/h (3 m<sup>3</sup>/h).

<sup>114</sup> NL: Immigration 3392, bailiffs ('deurwaarders') 880, forensics 580, ICT and Justice 389.

<sup>115</sup> Eurostat 2009, crim\_plce

<sup>116</sup> Ministry of the Interior NL, Kernegegevens personeel Overheid en Onderwijs 2008, The Hague 2009. Police officers 35 972 (equals Eurostat data), support staff 20 042, trainees 6 232. Total 62 246 police staff.

<sup>117</sup> Netherlands has 15% state police (military police (6800 staff), national police force KLPD (5000 staff) ) and 85% regional police. State police (RGD 2009) takes up 85.959 m<sup>2</sup> (ca. 5400 officers).

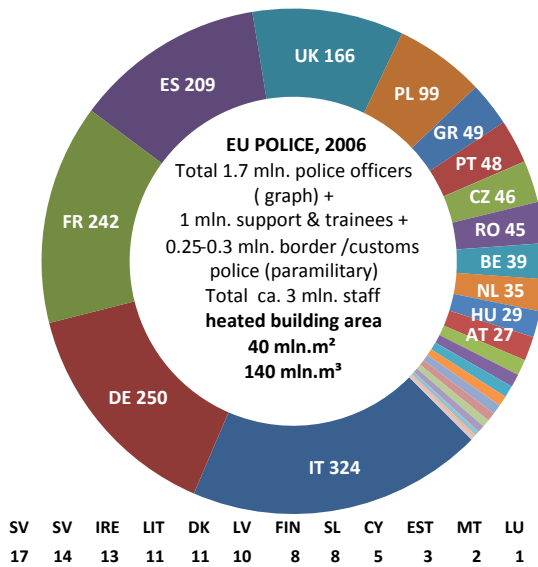

Figure D.3. EU Police, numbers and building volume (source: VHK)

### Defence

The EU Defence departments employ around 2.1 million active military staff <sup>118</sup> (2004), with around 15% (300.000) civilian support staff. The number of reservists varies widely per country, but they are not estimated to take up heated floor area (training facilities partitioned to active military staff). Para-military forces are not included under this heading, but included under the heading ‘police’. Total headcount of employees under the heading ‘Defence’ is thus estimated at 2.4 million. For the heated gross floor area only anecdotal were found, but is estimated at around 15 m<sup>2</sup> per person. <sup>119</sup> This results in 40 million m<sup>2</sup> floor area and an estimated 140 million m<sup>3</sup> of heated volume. <sup>120</sup>

<sup>118</sup> Active military staff: Wikipedia.nl. Ratio civilians/military taken from ibid. 11.

<sup>119</sup> Netherlands (53.150 military) occupies 47 army bases (Wikipedia). Gross floor area of buildings is around 25.000-40.000 m<sup>2</sup>. Part of this will be unheated. Estimated is 15.000 m<sup>2</sup> of heated floor area for around 1000 personnel.

<sup>120</sup> Netherlands (professional army only): 67.000 personnel, 85.496 m<sup>2</sup> gross floor area. In countries with drafted personnel specific floor area is believed to be factor 2 higher.



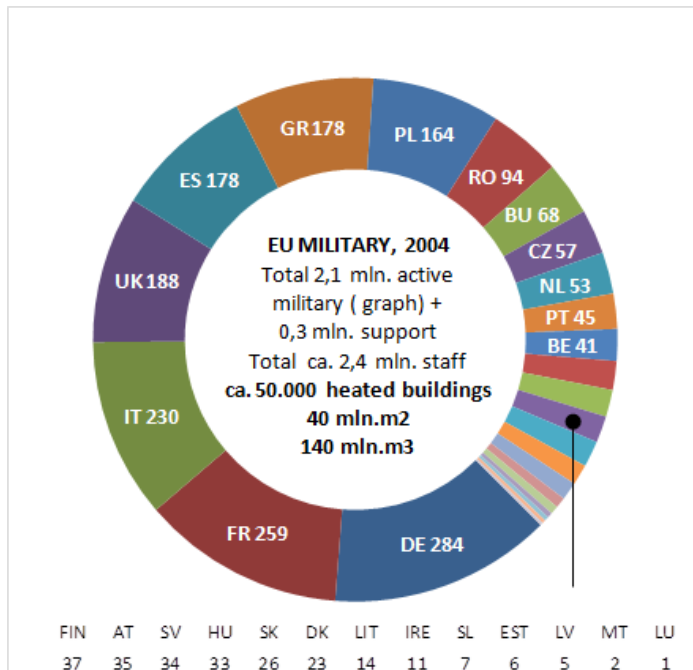

Figure D.3. EU Military, numbers and building volume (source: VHK)

### Home office and municipalities

The core department of the Home Office (a.k.a. ‘Ministry of Internal Affairs’) is estimated to account for around 4 million m<sup>2</sup> (16 million m<sup>3</sup>). But more importantly, the Home Office in many countries has the prime responsibility for the regional and local government, i.e. the ‘municipalities’.

In the EU around 6 million civil servants are working at regional and municipal level. Apart from the regulatory and policy activities, these jobs include municipal personnel for waste collection, public transport (often privatized), museums, libraries, archives, municipal health services (e.g. ambulances etc.), secretarial services and administration.

At an average of 20 m<sup>2</sup> per employee (80 m<sup>3</sup>/employee) this results in an extra 480 million m<sup>3</sup>, bringing the total to 500 million m<sup>3</sup>. Below the fire & rescue services are highlighted.

Fire & rescue services are mentioned as a separate NACE group, but statistics on the EU-27 fire & rescue services are relatively poor. The EU-27 has probably around a few million registered fire fighters, but only around 130-150 000 of those are professionals. The others are pure volunteers and

on 'Retained Duty Service' ("on-call"). Numbers and organizations differ between countries, based on national customs and geography.<sup>121</sup> The buildings of the fire brigades are mainly

unheated garages and do not contribute to the heated gross floor area. The estimate in the table is based primarily on a number of 150.000 professional firemen and a heated gross floor area of 20 m<sup>2</sup>/employee. This gives 3 million m<sup>2</sup> heated floor area and –at a floor height of 4.5 m, around 13.5 million m<sup>3</sup> of heated volume. Taking into account the heating of training and meeting facilities of the voluntary brigades this latter figure is rounded to 20 million m<sup>3</sup>.

### **Other public buildings (2008)**

The Finance department involves around 1 million tax office & customs staff and 100-200.000 central staff. Total gross floor area is estimated at 30 million m<sup>2</sup>, resulting in 110 million m<sup>3</sup>.

The ministry of Transport, co-ordinates building and maintenance of highways, bridges, waterways, etc. usually by hiring 3<sup>rd</sup> parties, but also by state agencies.

Foreign Affairs runs embassies and consulates (24 million m<sup>3</sup> extra). The Ministry of Social Affairs has extra personnel in the form of around 600 000 staff for the Social Service<sup>122</sup> ( 35 million m<sup>3</sup> extra)

International organizations are estimated to employ around 0.1 million people. Given the need for meeting space, the average floor area per employee is estimated at 44 m<sup>2</sup>. At a floor height of 4 m this results in about 18 million m<sup>3</sup>.

On top of the above, each department occupies around 4 million m<sup>2</sup> (16 million m<sup>3</sup>). For e.g. the PM office this is the only item on the balance.

### **Political and religious organizations**

Both national and Eurostat statistics on organizations in social, communication, entertainment and sports activities are notoriously unreliable: Definitions are not well defined, several activities are mixed between private and public and a great number of organizations are working with volunteers and overall the registration practice is poor. Nevertheless, VHK has pulled together the best available statistics and additional information in order to give an estimate of building stock and volume.

Even though the statistics offices register only a limited number of 11.000 'religious congregations', the church statistics show that there are around 150-200.000 ecclesiastical buildings (churches)<sup>123</sup>. There are no exact data on size, but it is estimated that an average church will have a volume of at least around 20.000 m<sup>3</sup> (e.g. 35 x 70 x 8 m). Their total volume will be at least some 4000 million m<sup>3</sup>. Even if they are heated to a temperature well below 18 °C and only at times of mass, weddings, etc., it is estimated that the hourly air change amounts to 1.000 million m<sup>3</sup>/h during the time that the

<sup>121</sup> A country like Austria boasts as much as 312 897 registered firemen, but out of the 4 894 fire brigades only 6 are professional, 333 are private company fire brigades and as much as 4 555 voluntary brigades. On the other side of the spectrum the Netherlands reports 500 fire brigades and 27 000 firemen, of which as much as 4500 are professionals and 22 500 are volunteers. In Germany, the Feuerwehr is organized in 33 000 locations with around 1.3 million firemen. The UK and Belgium organize their Fire & Rescue Services at regional level. E.g. Wales reports 151 Fire and Rescue stations and 1978 firemen, of which most volunteers. The Flanders (BE) professional association reports 12 000 members, of which 25% professionals and 75% volunteers.

<sup>122</sup> Kerngegevens: Zelfstandig Bestuursorgaan for Dutch Ministry of Social Affairs: 19.899 staff (2008)

<sup>123</sup> NL: around 2500 catholic churches, 450 mosques, 3-4000 protestant churches.

heating is on. To this the heating of convents has to be added. In total the ventilation losses will amount to around 1% of the EU-27 total.

### **Sports facilities**

The number of indoor swimming pools is 1 per 50.000 inhabitants in Western Europe, 1 per 300 000 inhabitants in Eastern Europe. Overall in the EU-27 this means around 5.000 indoor swimming pools, with a surface of at least 12 250 m<sup>3</sup> (25 x 35 x 10 m), up to 37 500 m<sup>3</sup> (50 x 50 x 15). At an average 20 000 m<sup>3</sup> per pool this means 100 million m<sup>3</sup>. But the average temperature is high, as is the ventilation effort.

The EU has at least 500 larger indoor sports arena's with an average capacity of 9 000 seats. (15.000 m<sup>3</sup> x 20 m= 300.000 m<sup>3</sup>). Indoor speed-skating halls (400 m tracks) are small in numbers but large in volume: There are an estimated 20 in the EU. At around 0.25 million m<sup>3</sup> per hall this results in 5 million m<sup>3</sup>. In total the volume of the larger indoor sports arena's is estimated at 155 million m<sup>3</sup>.

Finally, it is estimated that around 150 000 public (municipal) indoor sports courts (at 30 x 15 x 8m= 3 600 m<sup>3</sup> per court) outside of the ones in schools. This results in a heated volume of 540 million m<sup>3</sup>.<sup>124</sup>

---

<sup>124</sup> Example Ahoy (tennis): 30.000 m<sup>2</sup> x 20 = 600.000 m<sup>3</sup> x 30 → 18 mln. m<sup>3</sup>.

# ANNEX E: ENEV ENERGY BENCHMARKS

Table . EnEV 2007 average values and EnEV 2009 reference values

Ziffer nach BWZK	Gebaukategorie	Gebäude-grosse (Netto-grundflä- che) [m <sup>2</sup> ]	Mittelwerte = Vergleichswerte nach EnEV 2007		Vergleichswerte nach EnEV 2009	
			Heizung und Warmwasser	Strom	Heizung und Warmwasser	Strom
			[kWh/(m <sup>2</sup> NGF' a)]		[kWh/(m <sup>2</sup> NGF' a)]	
1	2	3	4	5	6	7
1100	Parlamentsgebäude	beliebig	100	55	70	40
1200	Gerichtsgebäude	≤ 3.500	125	25	90	20
		> 3.500	100	35	70	25
1300	Verwaltungsgebäude, normale techn. Ausstattung	≤ 3.500	115	30	80	20
		> 3.500	120	45	85	30
1311	Ministerien	beliebig	100	45	70	30
1320	Verwaltungsgebäude, hoherer techn. Ausstattung	beliebig	120	60	85	40
1340	Polizeidienstgebäude	beliebig	125	40	90	30
1350	Rechenzentren	beliebig	125	220	90	155
2100	Horsaalgebäude	beliebig	115	55	90	40
2200	Institutsgebäude für Lehre und Forschung	beliebig	150	95	105	65
2210	Institutsgebäude I 10	≤ 3.500	125	35	90	25
		> 3.500	120	50	85	35
2220	Institutsgebäude II 10	beliebig	160	75	110	55
2230	Institutsgebäude III 10	beliebig	135	95	95	65
2240	Institutsgebäude IV 10	beliebig	195	110	135	75
2250	Institutsgebäude V 10	beliebig	200	135	140	95
2300	Institutsgebäude für Forschung und Untersuchung	beliebig	190	90	135	65
2400	Fachhochschulen	beliebig	115	40	80	30
3000	Gebäude des Gesundheitswesens (ohne BWZK Nr. 3200)	beliebig	190	70	135	50
3200	Krankenhäuser und Uni- kliniken für Akutkranke	beliebig	360	180	250	125
4100	Allgemeinbildende Schulen	≤ 3.500	150	15	105	10
		> 3.500	125	15	90	10
4200	Berufsbildende Schulen	beliebig	115	25	80	20
4300	Sonderschulen	beliebig	150	20	105	15
4400	Kindertagesstätten	beliebig	160	25	110	20
4500	Weiterbildungseinrichtungen	beliebig	130	30	90	20
1311	Ministerien	beliebig	100	45	70	30
1320	Verwaltungsgebäude, hoherer techn. Ausstattung	beliebig	120	60	85	40
1340	Polizeidienstgebäude	beliebig	125	40	90	30
1350	Rechenzentren	beliebig	125	220	90	155
2100	Horsaalgebäude	beliebig	115	55	90	40
2200	Institutsgebäude für Lehre und Forschung	beliebig	150	95	105	65
2210	Institutsgebäude I 10	≤ 3.500	125	35	90	25
		> 3.500	120	50	85	35
2220	Institutsgebäude II 10	beliebig	160	75	110	55
2230	Institutsgebäude III 10	beliebig	135	95	95	65
2240	Institutsgebäude IV 10	beliebig	195	110	135	75
2250	Institutsgebäude V 10	beliebig	200	135	140	95
2300	Institutsgebäude für Forschung und Untersuchung	beliebig	190	90	135	65
2400	Fachhochschulen	beliebig	115	40	80	30
3000	Gebäude des Gesundheitswesens (ohne BWZK Nr. 3200)	beliebig	190	70	135	50
3200	Krankenhäuser und Uni- kliniken für Akutkranke	beliebig	360	180	250	125
4100	Allgemeinbildende Schulen	≤ 3.500	150	15	105	10
		> 3.500	125	15	90	10
4200	Berufsbildende Schulen	beliebig	115	25	80	20
4300	Sonderschulen	beliebig	150	20	105	15
4400	Kindertagesstätten	beliebig	160	25	110	20
4500	Weiterbildungseinrichtungen	beliebig	130	30	90	20
5000	Sportbauten (ohne BWZK Nr. 5100, 5200 und 5300) und Sondersportanlagen (Kegelbahnen, Schiess- anlagen, Reithallen, Eissporthallen, Tennishallen)	beliebig	170	40	120	30
5100	Hallen (ohne Schwimm- hallen)	beliebig	155	35	110	25
5200	Schwimmhallen	beliebig	775	220	425	155
5300	Gebäude für Sportplatz- und Freibadeanlagen (Umkleidegebäude, Tri- bunengebäude, Sporthei- me, Platzwartgebäude, Sportbetriebsgebäude)	beliebig	195	40	135	30

AVERAGE EU BUILDING HEAT LOAD FOR HVAC EQUIPMENT

<b>6300 bis 6600</b>	Gemeinschaftsunterkünfte, Betreuungseinrichtungen, Verpflegungseinrichtungen, Beherbergungsstätten	beliebig	150	30	105	20
<b>7000</b>	Gebäude für Produktion, Werkstätten, Lagergebäude (ohne BWZK Nr. 7700)	≤ 3.500	160	30	110	20
		> 3.500	160	90	110	65
<b>7700</b>	Gebäude für öffentliche Bereitschaftsdienste	beliebig	145	25	100	20
<b>8000</b>	Bauwerke für technische Zwecke	beliebig	155	60	110	40
<b>9100</b>	Gebäude für kulturelle und musische Zwecke (ohne BWZK Nr. 9120 bis 9150)	beliebig	90	30	65	20
<b>9120</b>	Ausstellungsgebäude	beliebig	110	60	75	40
<b>9130</b>	Bibliothekengebäude	beliebig	80	55	55	40
<b>9140</b>	Veranstaltungsgebäude	beliebig	155	60	110	40
<b>9150</b>	Gemeinschaftshäuser	beliebig	195	45	135	30
<b>9600</b>	Justizvollzugsanstalten	beliebig	260	60	180	40

Lfd. Nr	Nutzungsgruppe	Nutzung	Mittelwerte = Vergleichswerte nach EnEV 2007		Vergleichswerte nach EnEV 2009	
			Heizung und Warmwasser	Strom	Heizung und Warmwasser	Strom
			[kWh/(m²NGF'a)]		[kWh/(m²NGF'a)]	
1	2	3	4	5	6	7
1.1	Hotel, Beherbergung	Hotels ohne Stern, Pensionen, Gasthäuser, Hotels garni	215	70	150	50
1.2		Hotels mit 1 und 2 Sternen	120	75	85	55
1.3		Hotels mit 3 Sterne	135	85	95	60
1.4		Hotels mit 4 und 5 Sterne	150	95	105	65
1.5		Jugendherberge, Gasthäuser, Ferien-, Schul-, land-, Vereinsheime	125	25	90	20
2.1	Gaststätten	Ausschankwirtschaft	340	100	240	70
2.2		Speisegaststätte/Restaurant	290	135	205	95
2.3		Kantinen/Mensen	170	105	120	75
3.1	Veranstaltungsgebäude	Kino	80	115	55	80
3.2		Opernhäuser, Theatergebäude	155	60	110	40
3.3		Saalbauten, Stadthallen	155	60	110	40
3.4		Freizeitzentren, Jugendhäuser, Gemeindehäuser	150	30	105	20
4	Laborgebäude		Ermittlung der Vergleichswerte: Mittelwerte nach Nr. 7.4		Ermittlung der Vergleichswerte: 85% des Mittelwertes nach Nr. 7.4	
5.1	Sportanlagen	Sporthallen	170	50	120	35
5.2		Mehrzweckhallen	345	55	240	40
5.3		Schwimmbädern, Hallenbäder	550	150	385	105
5.4		Sportheim (Vereinsheim)	115	25	80	20
5.5		Fitnessstudios	140	170	100	120
6.1	Handel/Dienstleistung	Handel Non-Food, sonstige persönliche Dienstleistungen bis 300 m²	195	65	135	45
6.2		Handel Non-Food über 300 m²	105	85	75	60
6.3		Handel Food bis 300 m²	180	105	125	75
6.4		Handel Food über 300 m² sowie Metzgerei mit Produktion	135	375	95	265
6.5		Kaufhäuser, Warenhäuser, Einkaufszentren (Food und Non-Food)	100	120	70	85
6.6		Geschlossene Lagerhäuser, Speditionen	45	50	30	35
6.7		Kosmetik/Friseur	220	90	155	65
7.1	Gesundheitswesen	Krankenhäuser bis 250 Betten	205	120	145	84
7.2		Krankenhäuser von 251 bis 1000 Betten	250	115	175	80
7.3		Krankenhäuser mit über 1000 Betten	285	115	200	80
7.4		Freiberufliches Gesundheitswesen, Praxen	285	50	200	35
8.1	Verkehrsinfrastruktur	Flughafen, Terminal	190	290	135	205
8.2		Flughafen, Frachthallen	170	100	120	70
8.3		Flughafen, Wartung/Hangar	385	90	270	65
8.4		Flughafen, Werkstätten	220	210	155	150
8.5		Bahnhof (inkl. Vermarktungsbereich) < 5000 m²	170	45	120	30
8.6	Bahnhof (inkl. Vermarktungsbereich) ≥ 5000 m²	165	140	115	100	
9.1	Bürogebäude	Bürogebäude, nur beheizt	150	50	105	35
9.2		Bürogebäude, temperiert und belüftet	160	120	110	85
9.3		Bürogebäude mit Vollklimaanlage, Konditionierung unabhängig von der Aussentemperatur	190	150	135	105

