

*EU SCIENTIFIC SEMINAR*  
***EMERGING ISSUES WITH REGARD TO ORGAN DOSES***  
*Luxembourg, 17 May 2017*

---

**Issues related to the concept of organ dose**

---

**Augusto Giussani**

**On behalf of EURADOS**

*BfS, Germany - [agiussani@bfs.de](mailto:agiussani@bfs.de)*

---

## The definition of absorbed dose and its limitations.

Absorbed dose is defined on pure physical grounds.

$$D = \frac{d\bar{\varepsilon}}{dm}$$

Mean energy imparted to matter of mass  $dm$

$$D_T = \frac{\bar{\varepsilon}}{m_T}$$

For practical purposes dose quantities are generally referred to finite volumes (organs, tissues or substructures thereof)

# The definition of absorbed dose and its limitations.

Absorbed dose is defined on pure physical grounds.

It generally provides a "quantitative description" of the interaction between ionizing radiation and exposed materials.

Not adequate for the purpose of radiation protection:

- the dose-response relation for a particular biological system depends on the radiation quality, i.e. the spectrum of particles and their energies, and the stochastic pattern of energy deposition
- different biological systems, such as e.g. different tissue types in the human body, have different susceptibilities for producing radiation-induced effects
- many biological processes are non-linear: the overall response of a biological system may depend on the temporal pattern of the irradiation (effects of dose rate and fractionation) and be substantially affected in case of non-uniform exposures (whole-body vs. partial body exposure, inhomogenous activity distribution for incorporated radionuclides...)

## Radiation protection quantities defined by ICRP.

ICRP has defined the protection quantities **equivalent dose**  $H_T$  for organs and tissues of the human body, and **effective dose**  $E$  as the weighted sum of the equivalent doses.

ICRP 60

$$H_T = \sum_R w_R D_{T,R}$$

$$E = \sum_T w_T H_T + w_{rem} H_{rem}$$

ICRP 103

$$E = \sum_T w_T \left[ \frac{H_T^M + H_T^F}{2} \right]$$

$$H_{rem}^M = \frac{1}{13} \sum_T H_T^M$$

$$H_{rem}^F = \frac{1}{13} \sum_T H_T^F$$

## Limitations on the use of equivalent dose and effective dose.

Equivalent and effective dose are not *directly measurable*.

Effective dose is intended for use as a protection quantity on the basis of *reference values*. The weighting factors used are those assessed for appearance of *stochastic effects* at low-dose, low-dose-rate levels. As a consequence, the quantities equivalent dose and effective dose with their unit with the special name sievert (Sv) *should not be used* in determining the need for any treatment in situations where tissue reactions (deterministic effects) are caused.

Effective dose is not recommended for epidemiological evaluations, or for detailed specific retrospective investigations of individual exposure and risk. *Absorbed dose* should be used with the most appropriate biokinetic biological effectiveness and risk factor data. *Organ or tissue doses*, not effective doses, *are required for assessing the probability of cancer induction* in exposed individuals.

# Identification of radiation targets.

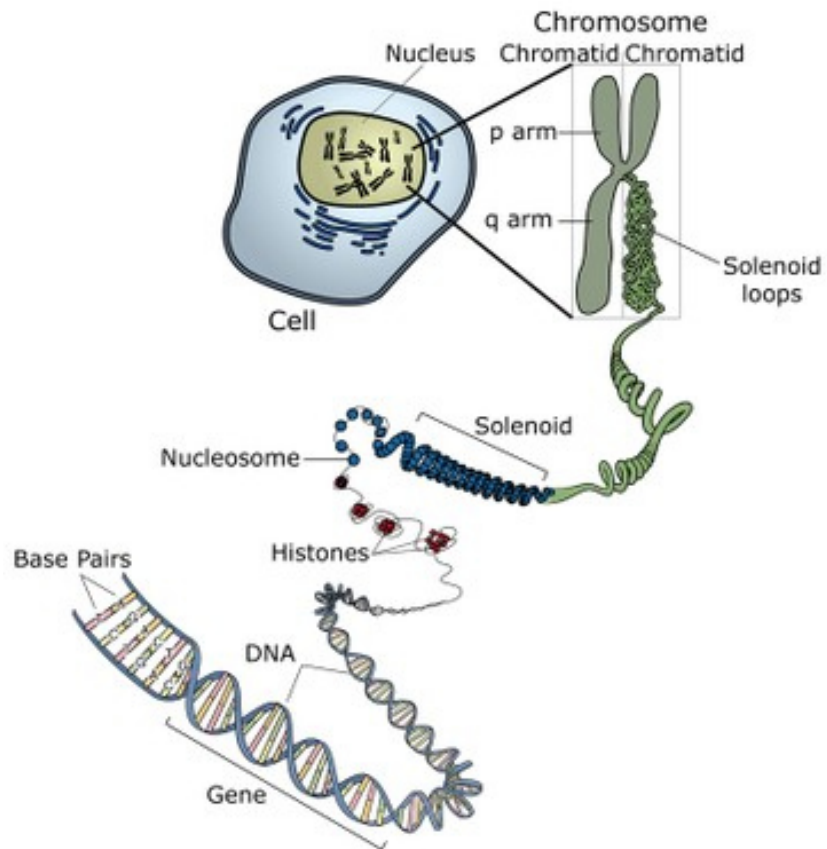

Image adapted from: National Human Genome Research Institute.

## Organ doses for incorporated radionuclides.

Incorporated radionuclides are characterized by *spatially and temporally inhomogeneous* dose distributions within a tissue or organ, particularly in the case of high-LET radiation.

Dose quantities averaged over the whole organ mass may not be appropriate for the estimation of biological effects of low doses.

Inhomogeneities are due to both

- *Non-uniform activity deposition* in the tissue
- *Location of the sensitive cells* in the target tissue

Compartments in biokinetic models used to describe distribution of radionuclides in the body correspond to whole organs or groups of organs. When substructures are considered, reliable data for the characterization of the corresponding parameters are hardly available, if any.

# Example of a biokinetic model for incorporated radionuclides.

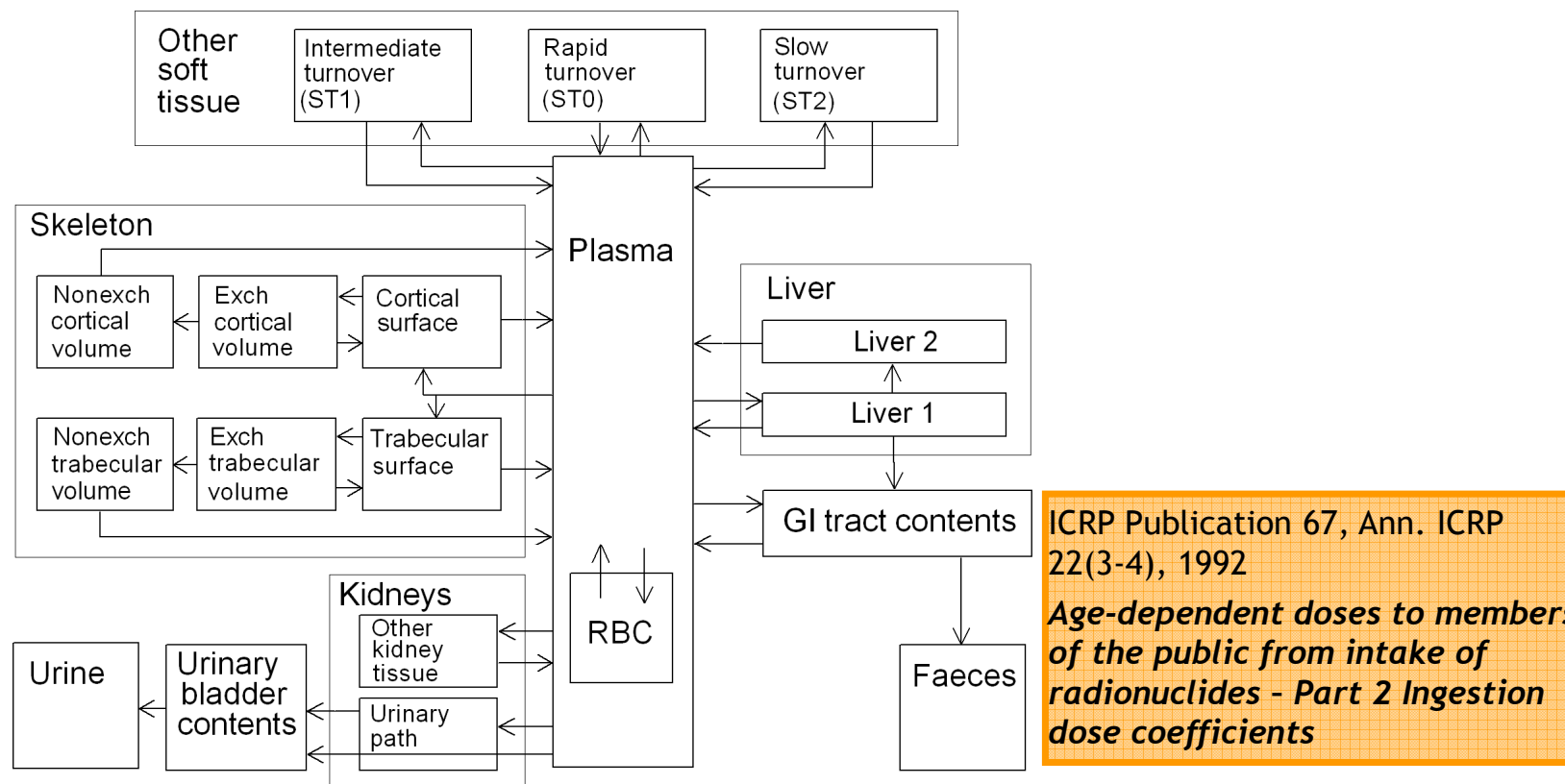



# New models of respiratory and alimentary tract include age- and sex-specific features.

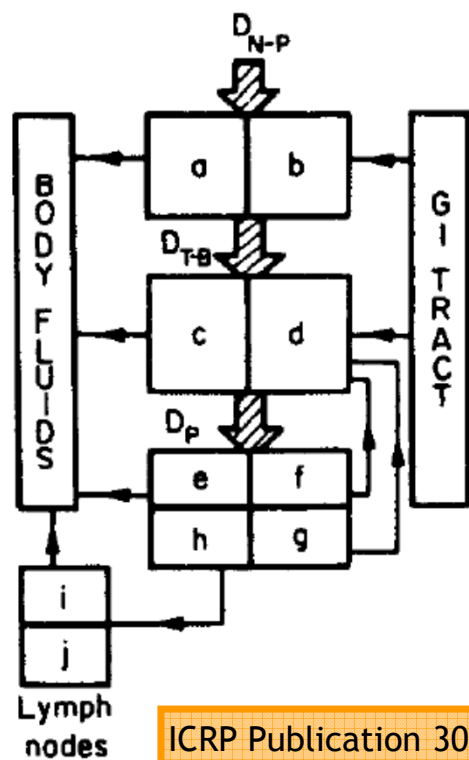

ICRP Publication 30  
(Part 1) Ann. ICRP  
2 (3-4), 1979

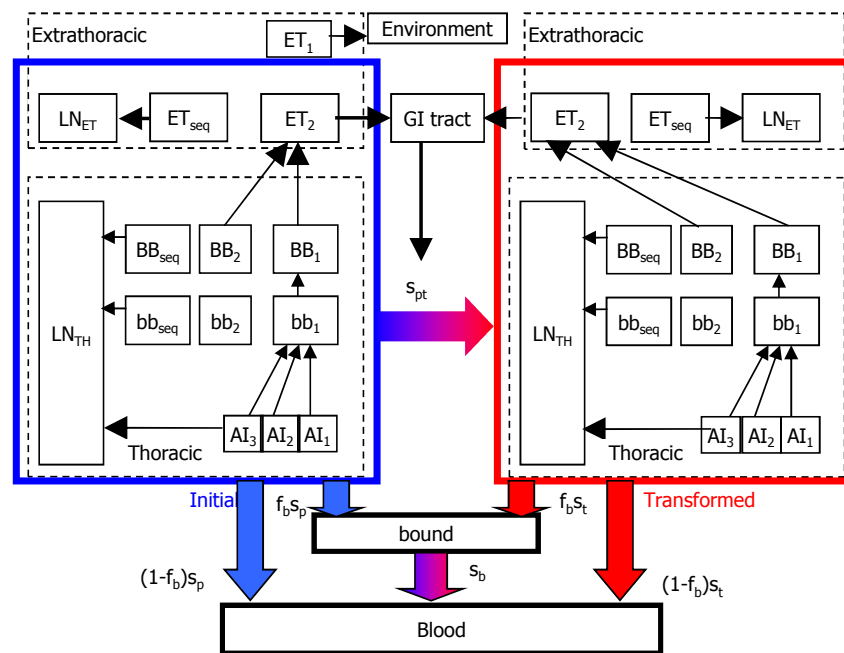

ICRP Publication 66, Ann. ICRP 24 (1-3), 1994  
*Human respiratory tract model for radiological protection*

# The new structures are physiologically more realistic.

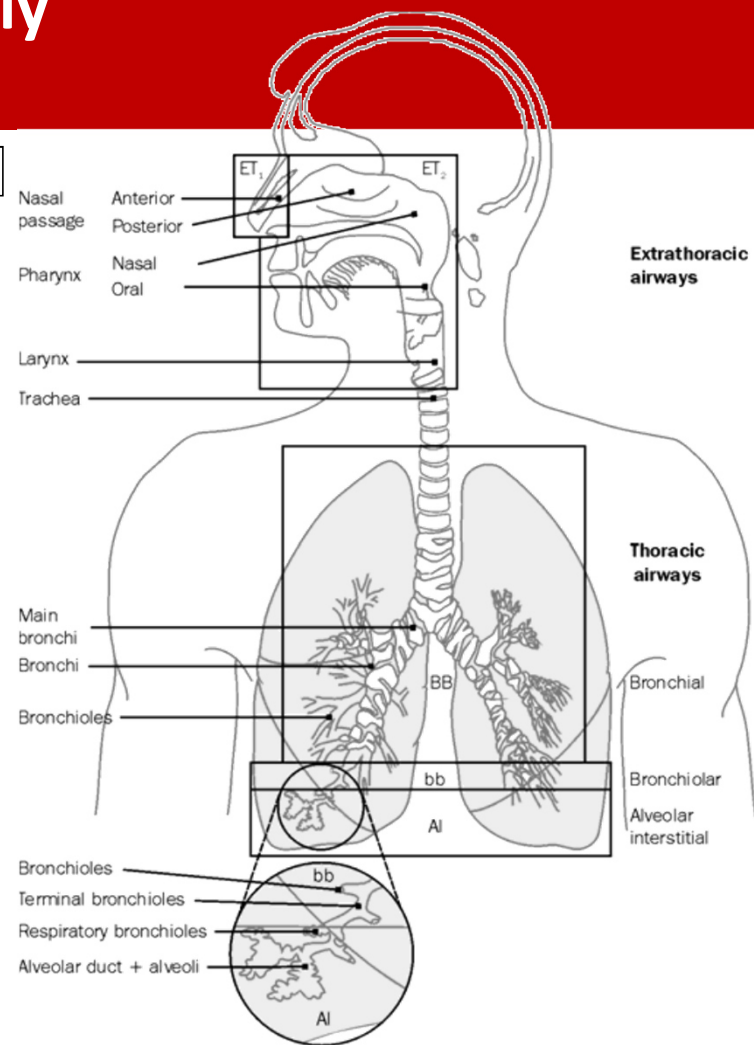
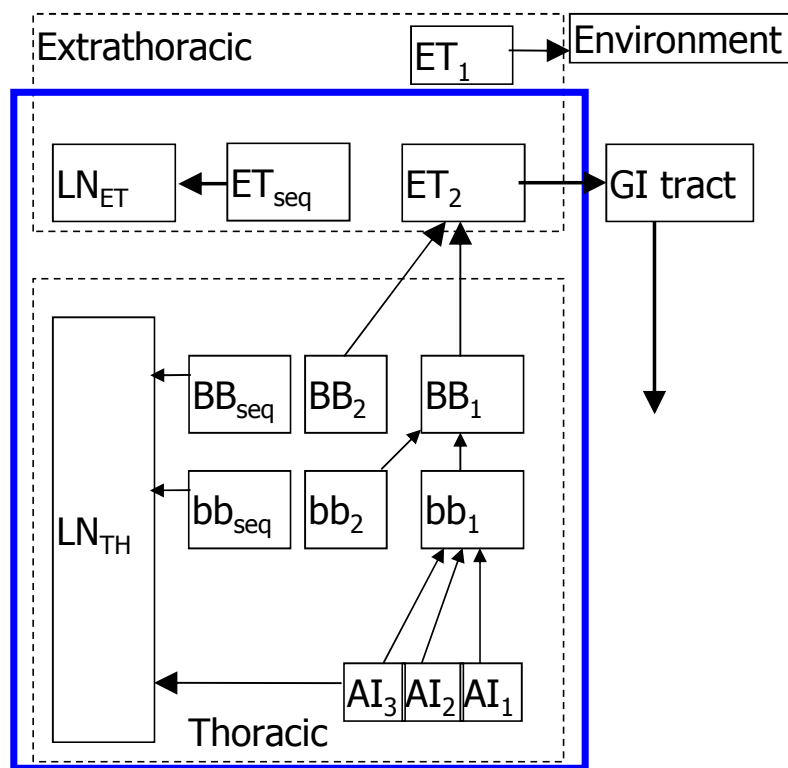

# The new structures are physiologically more realistic.

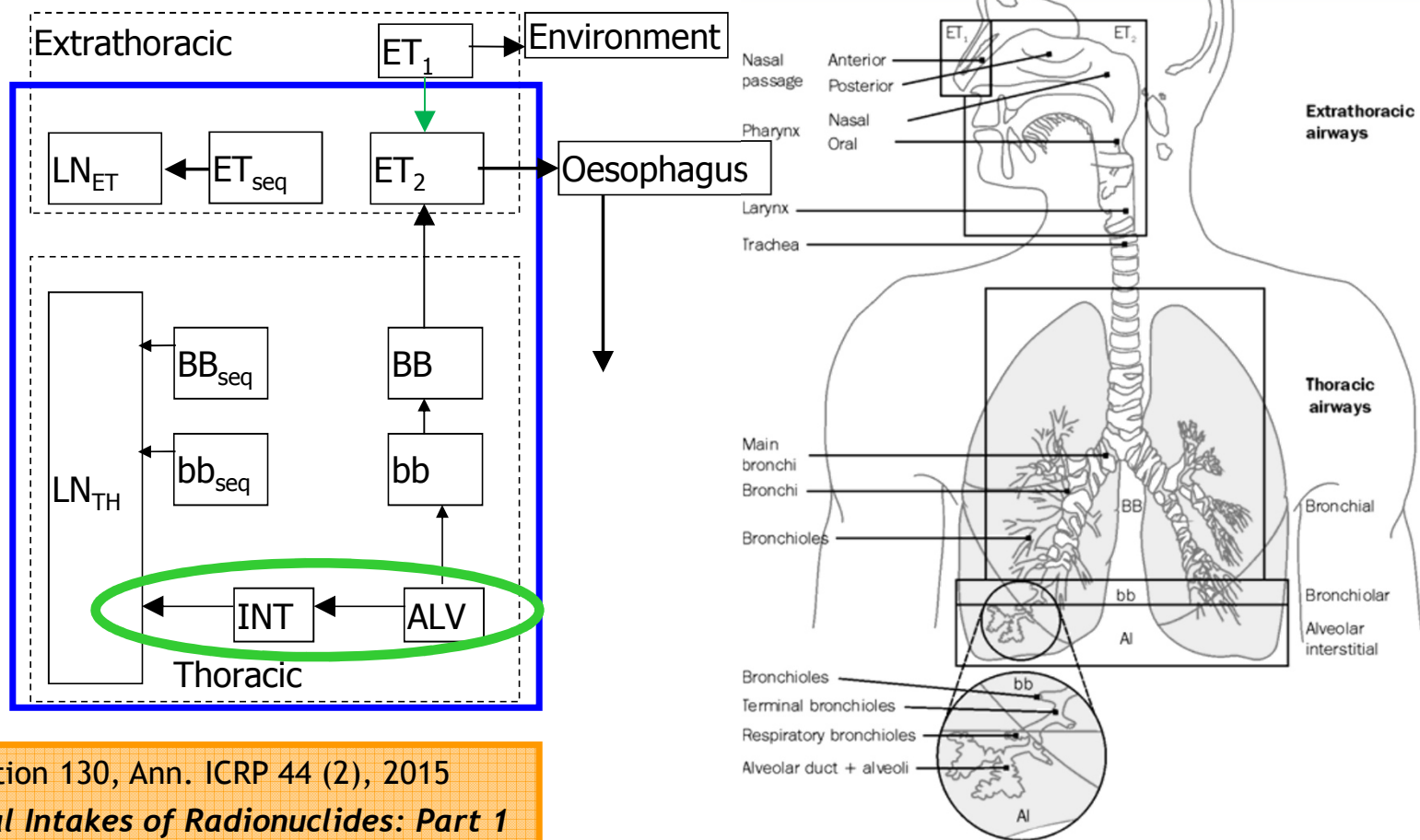

ICRP Publication 130, Ann. ICRP 44 (2), 2015  
**Occupational Intakes of Radionuclides: Part 1**

# Phantoms used for calculation of conversion coefficients gets more realistic and fine-detailed.

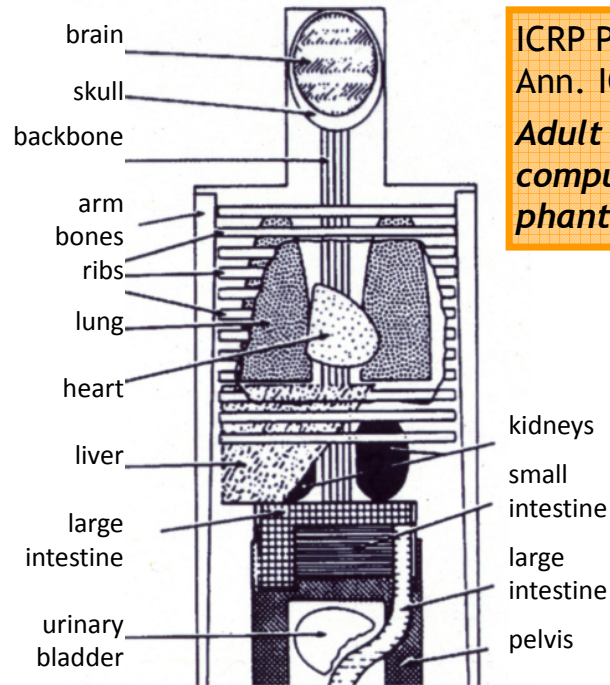

ICRP Publication 110,  
Ann. ICRP 39 (2), 2009  
**Adult reference  
computational  
phantoms**

**Mathematical phantom  
MIRD 5**

*replaced by  
voxel-phantoms*



Courtesy of Maria Zankl, HMGU

## Phantoms used for calculation of conversion coefficients gets more realistic and fine-detailed.

- Code Monte Carlo EGSnrc
- Voxel phantoms ("Reference computational phantoms") of adult male and female
- *Activity is assumed to be uniformly distributed* within the source region
- 25 energy values (10 keV – 10 MeV)
- 69 target organs and tissues
- 39 source organs and tissues
- Uncertainties lower than 5 %
- Nuclear data from new ICRP Publication 107

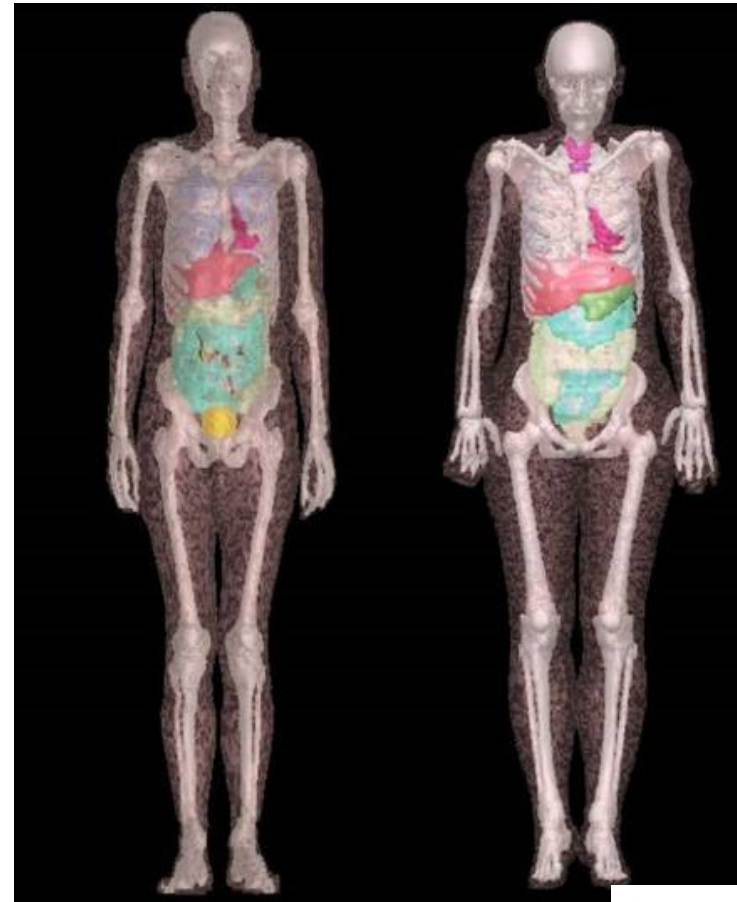

Courtesy of Maria Zankl, HMGU

## Doses are calculated at organ/tissue levels

$$H_{LUNG} = H_{TH} = H_{BB}A_{BB} + H_{bb}A_{bb} + H_{AI}A_{AI}$$

$$H_{ET} = H_{ET_1}A_{ET_1} + H_{ET_2}A_{ET_2}$$

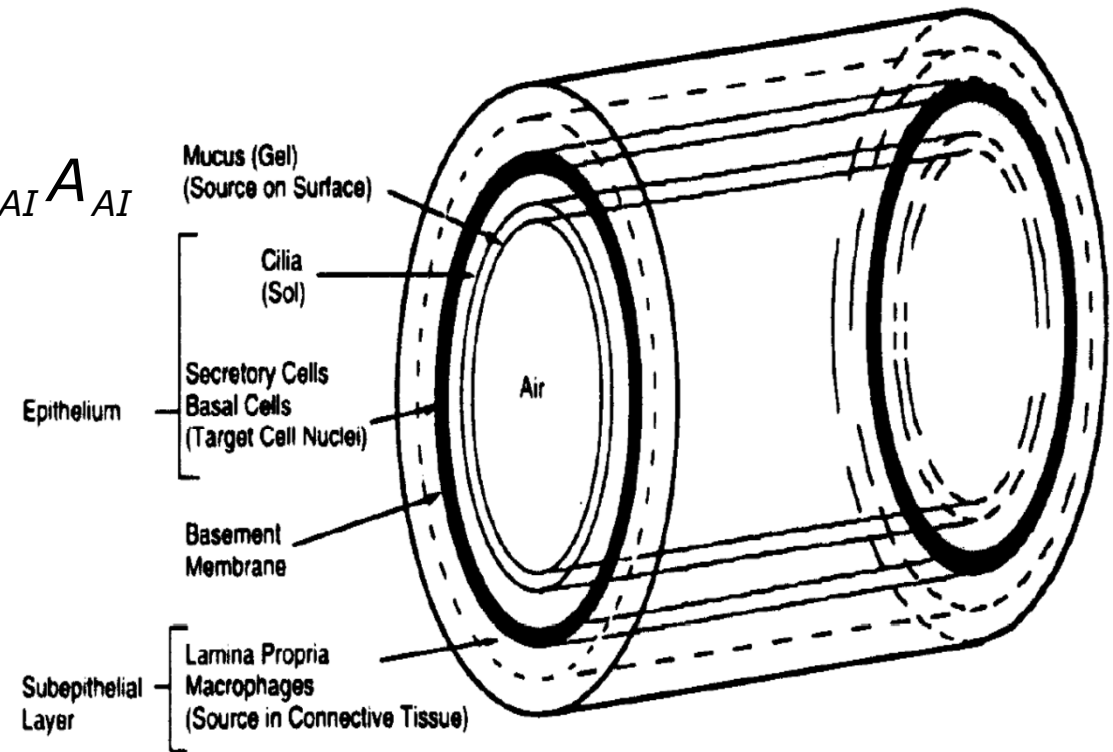

Fig. 2. Simplified geometrical model of various sources and targets involved in dosimetry of bronchial and extrathoracic epithelial tissues.

## Micro- and nanodosimetry approaches.

- Inhomogeneities of radiation burden (both in space and time) may strongly influence the biological responses.
- Particularly valid for internal exposure due to alpha- and Auger-emitters (very short range of the emitted radiation).
- Paradigm of internal dosimetry (average dose to an organ or tissue) no longer valid.
- Experimental and computational tools are available for micro- and nanodosimetric evaluation.
- EXAMPLE: quantification of the degree of inhomogeneity of deposited radon progenies in central airways and related biological effects by means of a 3D CFD model and radiobiological models.



# Example: Microdosimetric model for inhaled radon progeny (New Mexico Uranium miners).

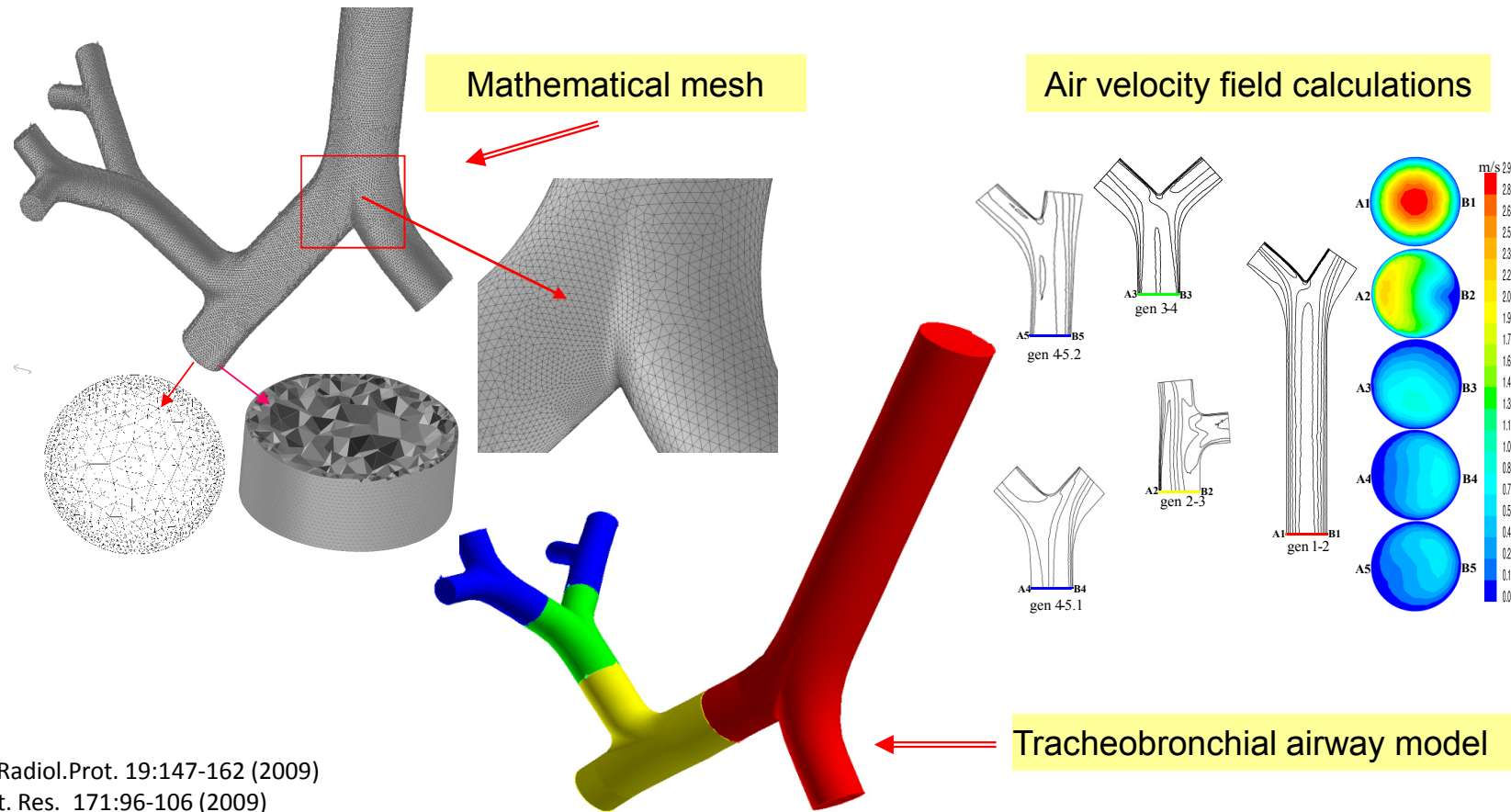

Balashazy et al., J.Radiol.Prot. 19:147-162 (2009)

Szoke et al., Radiat. Res. 171:96-106 (2009)



## Deposition distribution of attached and unattached particles.

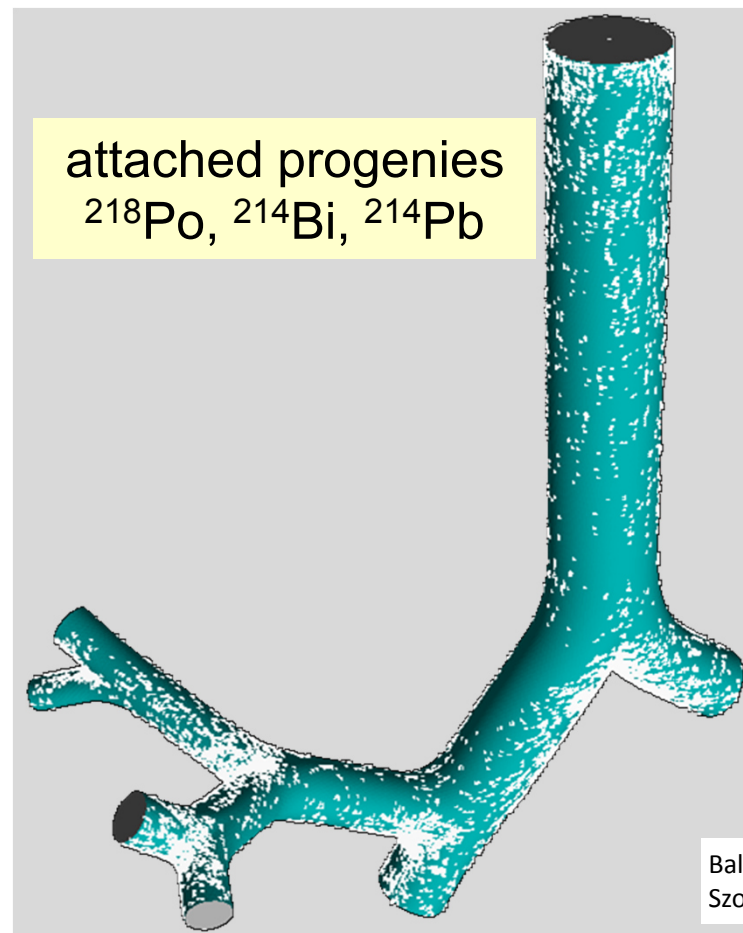
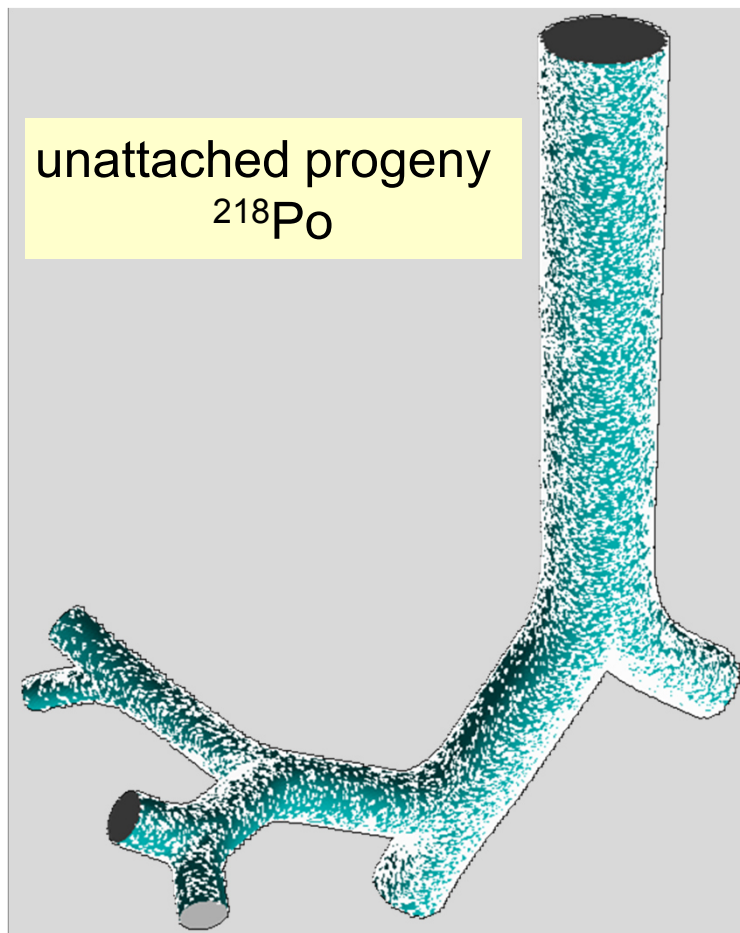

Balashazy et al., J.Radiol.Prot. 19:147-162 (2009)  
Szoke et al., Radiat. Res. 171:96-106 (2009)

## Hit cell nuclei.

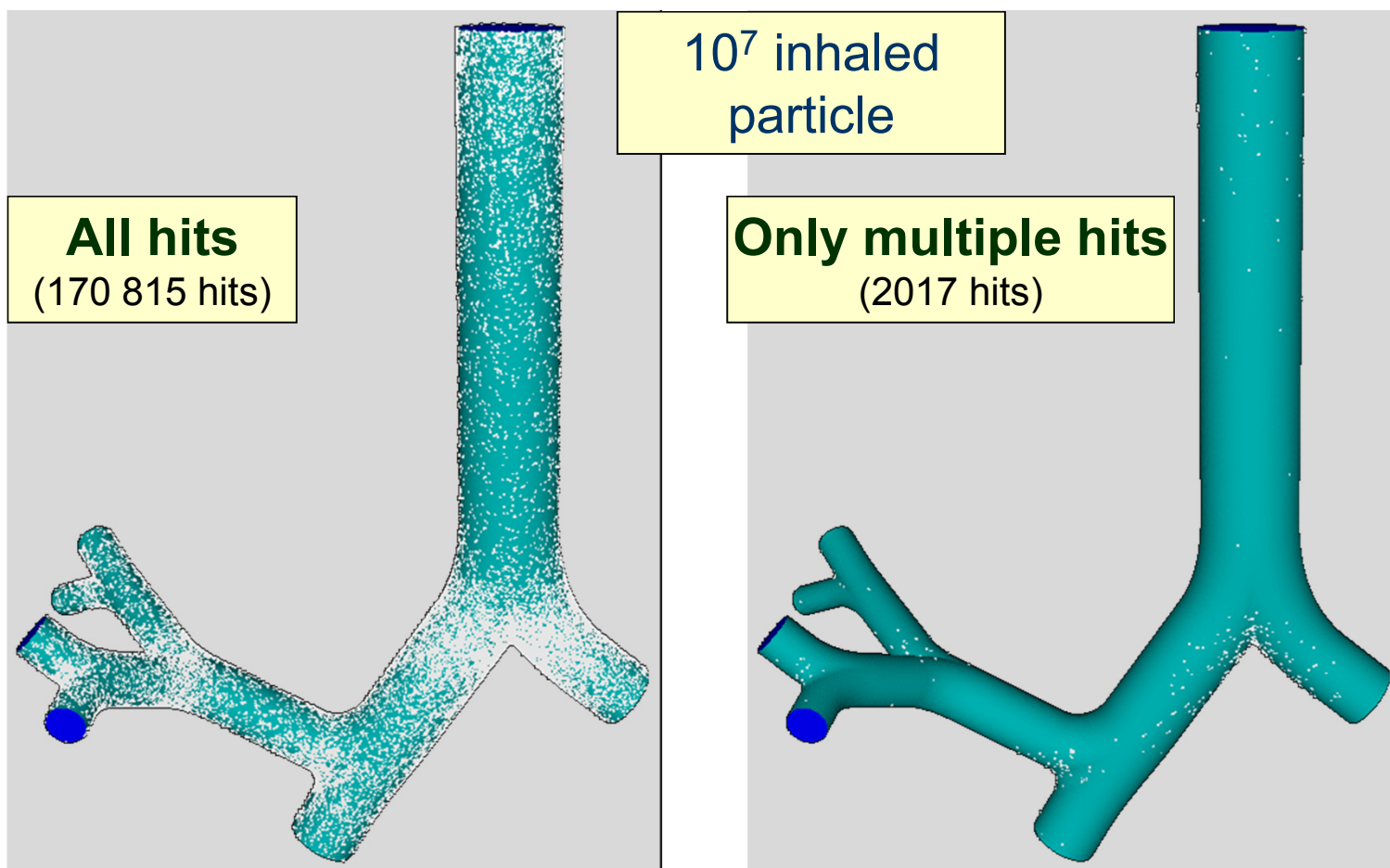

# Radiobiological considerations are introduced to evaluate radiation effects.

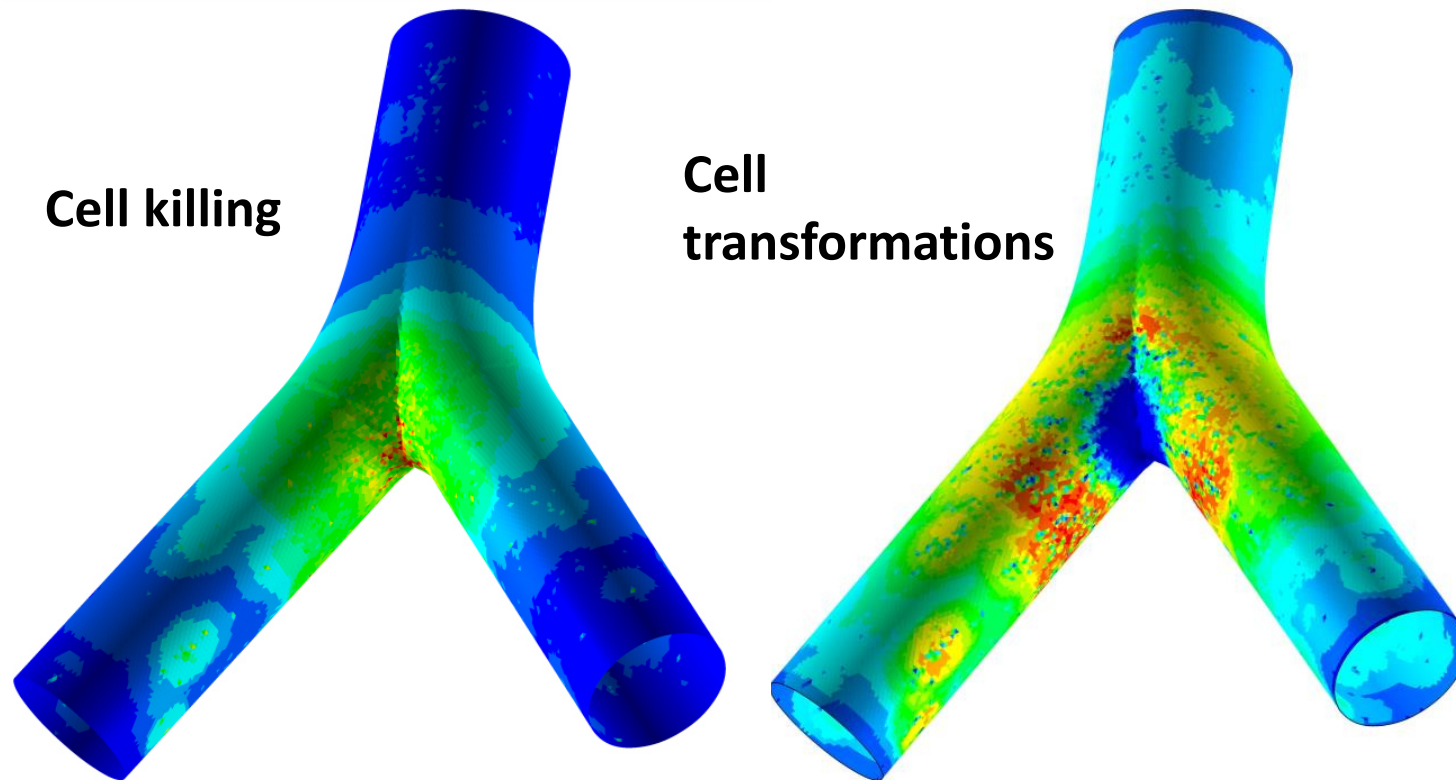

Balashazy et al., J.Radiol.Prot. 19:147-162 (2009)  
Szoke et al., Radiat. Res. 171:96-106 (2009)

# EURADOS Strategic Agenda

 EURADOS  
European Radiation Dosimetry Group e. V.

EURADOS Report 2014-01  
Braunschweig, May 2014

## Vision 1:

### Towards updated fundamental dose concepts and quantities

- To improve understanding of spatial correlations of radiation interaction events
- To establish correlations between track structure and radiation damage
- To improve understanding of radiation-induced effects from internal emitters
- To update operational quantities for external exposure.

#### **Visions for Radiation Dosimetry over the Next Two Decades - Strategic Research Agenda of the European Radiation Dosimetry Group**

W. Rühm, E. Fantuzzi, R. Harrison, H. Schuhmacher, F. Vanhavere, J. Alves, J.F. Bottollier-Depois, P. Fattibene, Ž. Knežević, M.A. Lopez, S. Mayer, S. Miljanić, S. Neumaier, P. Olko, H. Stadtmann, R. Tanner, C. Woda

ISSN 2226-8057  
ISBN 978-3-943701-06-7

## The four challenges.

- To improve the understanding of spatial correlations of radiation interaction events  
Micro- and nanodosimetry techniques providing a pure physical characterization of microscopic track structure could pave the way for new concepts for quantifying radiation effects in terms of radiation field properties.  
Development of measurement devices for track structure properties: miniaturized tissue-equivalent proportional counters, solid-state microdosimeters based on silicon, calorimetric microdosimeters measuring energy deposition directly in tissue-equivalent material, nanodosimetric devices based on the radiation-induced change in resistance of electrical circuits built from DNA molecules.

## The four challenges.

- To quantify correlations between track structure and radiation damage  
Potential weighting functions for track structure characteristics that allow predictions of biological effects based on track structure measurements: Prerequisite for new dosimetric concepts quantifying radiation effects at the level of individual cells or small tissue compartments.  
Identification and validation of new biomarkers at cellular (microbeam alpha exposure), tissue (in vitro 3D-reconstituted bronchial epithelium tissue model), and systemic level (human samples from existing biobanks).
- To improve the understanding of the biokinetics of internal emitters  
Microdosimetric approach is needed for alpha and beta emitters, (e.g. Pu- or Sr-isotopes in the skeleton, or short-lived radon progenies in the lungs, or Auger emitters).
- To update operational quantities for external exposure

## The role of uncertainties.

The establishment of uncertainty budgets for measured nanodosimetric quantities is an important task for the future, where the budget needs to take into account all sources of uncertainty including bias introduced through incomplete collection of the ions produced in the target.

Deriving estimates of the uncertainty of nanodosimetric characteristics of track structure is also a major need for the computational methods used for numerical simulation of particle tracks.

A thorough uncertainty analysis is required to show that the introduction of eventual new approaches and defined quantities represents an effective advantage with respect to the current definitions.